







Assembly code	Assembly description	Assembly image
ASM2911B/0.D20	Cooking chamber	
ASM2916C/0.D07	External cover	
ASM2921B/0.D08	Door	
ASM2926A/0.D06	Electrical system	



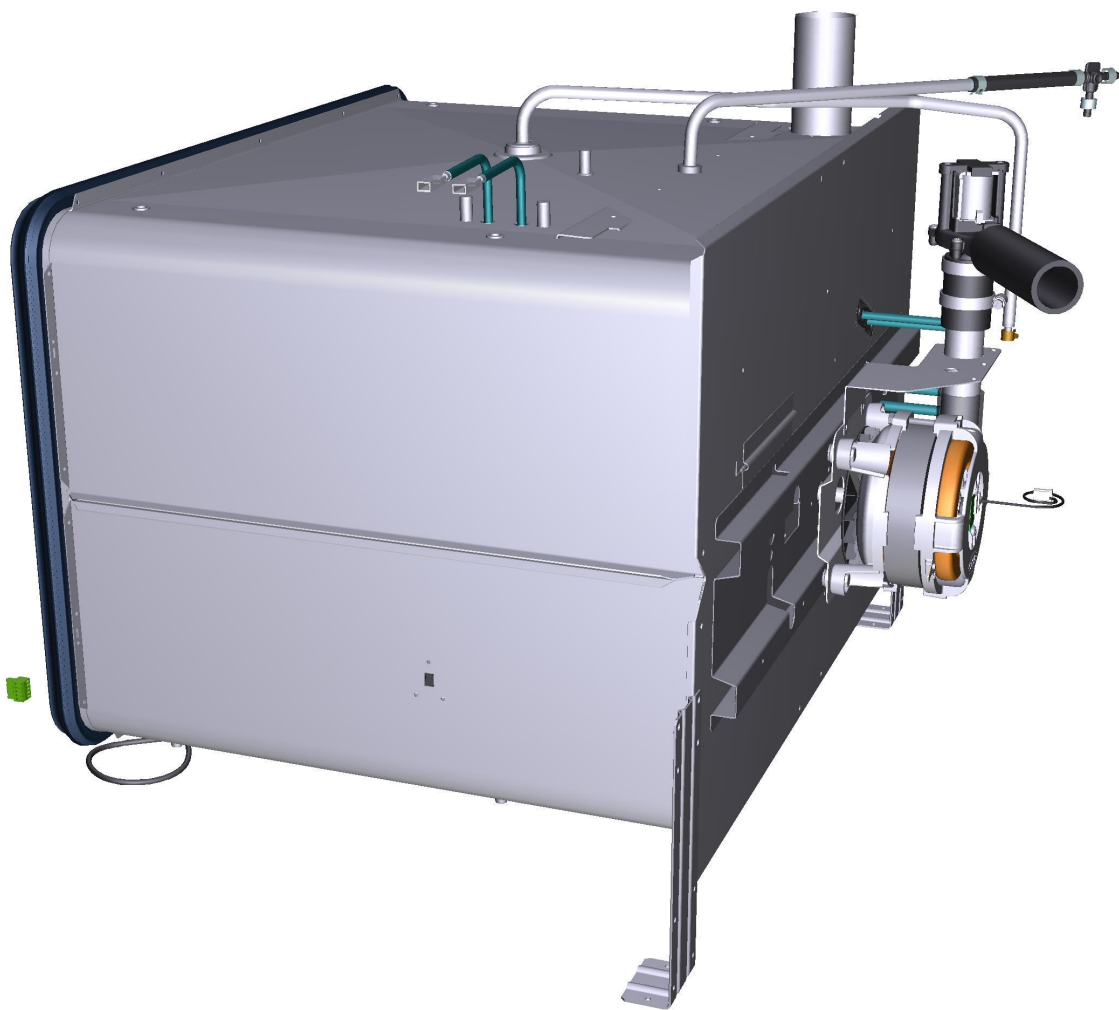

ASM2911B/0.D20 - Cooking chamber - FRONT





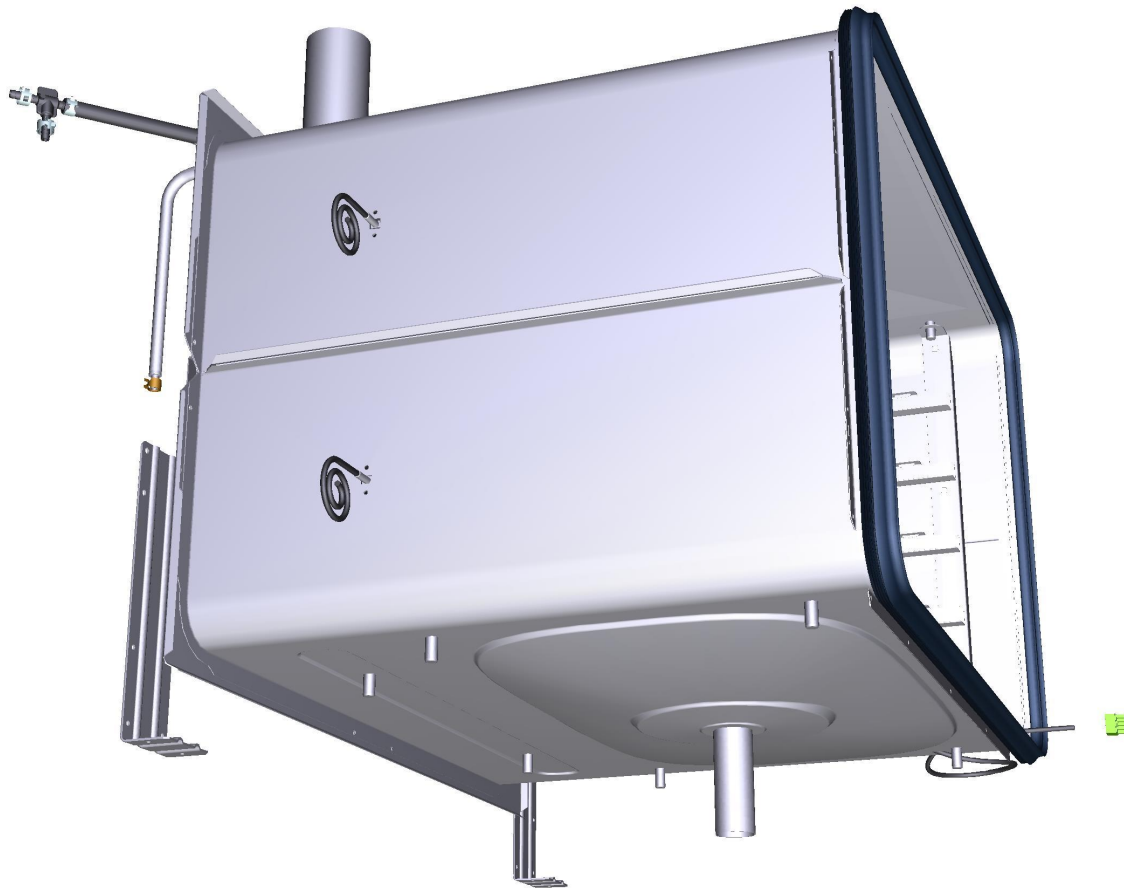

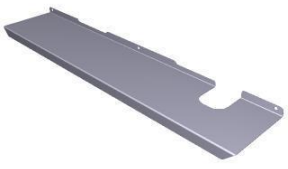
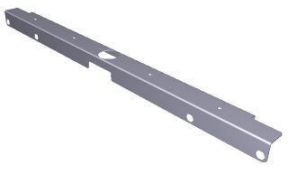



ASM2911B/0.D20 - Cooking chamber - REAR







COMPONENT			SPARE PART																										
Code	Description	Image	Code	Description	Kit components																								
0G1558A	DISTANZIALE CARTER ARIA		K0G1558A	SPACER FAN GUARD KIT	<table border="1"> <thead> <tr> <th>Code</th> <th>Description</th> <th>Qty</th> <th>UOM</th> </tr> </thead> <tbody> <tr> <td>0G1183A1</td> <td>DISTANZIALE CARTER ARIA 316L</td> <td>1.000</td> <td>PZ</td> </tr> </tbody> </table>	Code	Description	Qty	UOM	0G1183A1	DISTANZIALE CARTER ARIA 316L	1.000	PZ																
Code	Description	Qty	UOM																										
0G1183A1	DISTANZIALE CARTER ARIA 316L	1.000	PZ																										
0G1562B	FAN GUARD UPPER FIXING PANEL		K0G1562B	FAN GUARD UPPER FIXING PLATE KIT	<table border="1"> <thead> <tr> <th>Code</th> <th>Description</th> <th>Qty</th> <th>UOM</th> </tr> </thead> <tbody> <tr> <td>0G1182A1</td> <td>LAMIERA FISSAGGIO SUP CARTER 316</td> <td>1.000</td> <td>PZ</td> </tr> <tr> <td>VI1220A1</td> <td>VITE AUTOFIL. 4.2X11 TCS+ MARUTEX</td> <td>4.000</td> <td>PZ</td> </tr> <tr> <td>VI1340A0</td> <td>INSERTO FILETTATO M6 FTT/E INOX</td> <td>4.000</td> <td>PZ</td> </tr> <tr> <td>VI1836A0</td> <td>VITE M6x12 TE FLANGIA LISCIA OT63</td> <td>1.000</td> <td>PZ</td> </tr> <tr> <td>VM1820A0</td> <td>NOTTOLINO M6 CROMATO FISS. SUPPORTI</td> <td>1.000</td> <td>PZ</td> </tr> </tbody> </table>	Code	Description	Qty	UOM	0G1182A1	LAMIERA FISSAGGIO SUP CARTER 316	1.000	PZ	VI1220A1	VITE AUTOFIL. 4.2X11 TCS+ MARUTEX	4.000	PZ	VI1340A0	INSERTO FILETTATO M6 FTT/E INOX	4.000	PZ	VI1836A0	VITE M6x12 TE FLANGIA LISCIA OT63	1.000	PZ	VM1820A0	NOTTOLINO M6 CROMATO FISS. SUPPORTI	1.000	PZ
Code	Description	Qty	UOM																										
0G1182A1	LAMIERA FISSAGGIO SUP CARTER 316	1.000	PZ																										
VI1220A1	VITE AUTOFIL. 4.2X11 TCS+ MARUTEX	4.000	PZ																										
VI1340A0	INSERTO FILETTATO M6 FTT/E INOX	4.000	PZ																										
VI1836A0	VITE M6x12 TE FLANGIA LISCIA OT63	1.000	PZ																										
VM1820A0	NOTTOLINO M6 CROMATO FISS. SUPPORTI	1.000	PZ																										
0H2551A	ST STEEL DRAIN GRID		K0H2551A	DRAIN COVER KIT	<table border="1"> <thead> <tr> <th>Code</th> <th>Description</th> <th>Qty</th> <th>UOM</th> </tr> </thead> <tbody> <tr> <td>0H2617A0</td> <td>GRIGLIA DI SCARICO AISI316</td> <td>1.000</td> <td>PZ</td> </tr> </tbody> </table>	Code	Description	Qty	UOM	0H2617A0	GRIGLIA DI SCARICO AISI316	1.000	PZ																
Code	Description	Qty	UOM																										
0H2617A0	GRIGLIA DI SCARICO AISI316	1.000	PZ																										
0H2730A	ZINC PLATED MUFFLE SUPPORT BRACKET		0H2730A1	ZINC PLATED MUFFLE SUPPORT BRACKET																									



COMPONENT			SPARE PART																																		
Code	Description	Image	Code	Description	Kit components																																
0H7320A	MM VENTURI PIPE SUPPORT		0H7320A0	MM VENTURI PIPE SUPPORT																																	
PE1710B	SENSORE MODULARE NUM GIRI E DIREZIONE		KPE1710B	MOTOR REVOLUTIONS SENSOR KIT	<table border="1"> <thead> <tr> <th>Code</th> <th>Description</th> <th>Qty</th> <th>UOM</th> </tr> </thead> <tbody> <tr> <td>CE1119A0</td> <td>CAVO AMPMODU2 4P 4xAWG22 L1500 RAST 4</td> <td>1.000</td> <td>PZ</td> </tr> <tr> <td>PE1040A0</td> <td>SENSORE RAST NUM GIRI E VERSO MOTORE</td> <td>1.000</td> <td>PZ</td> </tr> <tr> <td>VI1966A1</td> <td>VITE M4X14 TSP+ ZN</td> <td>1.000</td> <td>PZ</td> </tr> <tr> <td>VM1447A0</td> <td>BUSTA AIRBALL ESD ROSA 230X450 MM</td> <td>0.500</td> <td>PZ</td> </tr> <tr> <td>VM2880A0</td> <td>ASM MGT MISURA NUMERO GIRI</td> <td>1.000</td> <td>PZ</td> </tr> </tbody> </table>	Code	Description	Qty	UOM	CE1119A0	CAVO AMPMODU2 4P 4xAWG22 L1500 RAST 4	1.000	PZ	PE1040A0	SENSORE RAST NUM GIRI E VERSO MOTORE	1.000	PZ	VI1966A1	VITE M4X14 TSP+ ZN	1.000	PZ	VM1447A0	BUSTA AIRBALL ESD ROSA 230X450 MM	0.500	PZ	VM2880A0	ASM MGT MISURA NUMERO GIRI	1.000	PZ								
Code	Description	Qty	UOM																																		
CE1119A0	CAVO AMPMODU2 4P 4xAWG22 L1500 RAST 4	1.000	PZ																																		
PE1040A0	SENSORE RAST NUM GIRI E VERSO MOTORE	1.000	PZ																																		
VI1966A1	VITE M4X14 TSP+ ZN	1.000	PZ																																		
VM1447A0	BUSTA AIRBALL ESD ROSA 230X450 MM	0.500	PZ																																		
VM2880A0	ASM MGT MISURA NUMERO GIRI	1.000	PZ																																		
RS1180A	RESISTENZA 6 SPIRE 9 KW 230V		KRS1180A	230V 9kW 6 TURNS HEATING ELEMENT KIT	<table border="1"> <thead> <tr> <th>Code</th> <th>Description</th> <th>Qty</th> <th>UOM</th> </tr> </thead> <tbody> <tr> <td>GN1671A0</td> <td>GUARNIZIONE RES 141x22 G8.5 ARMATA</td> <td>1.000</td> <td>PZ</td> </tr> <tr> <td>RS1180A1</td> <td>RESISTENZA 6 SPIRE 9 KW 230V</td> <td>1.000</td> <td>PZ</td> </tr> <tr> <td>SL1045A0</td> <td>SILICONE ANTRACITE S57 80 ml</td> <td>1.000</td> <td>PZ</td> </tr> <tr> <td>VI1032A0</td> <td>VITE M4X16 TCB+ INOX</td> <td>1.000</td> <td>PZ</td> </tr> <tr> <td>VI1075A0</td> <td>DADO M4 H=4 INOX UNI5587</td> <td>1.000</td> <td>PZ</td> </tr> <tr> <td>VI1220A1</td> <td>VITE AUTOFIL 4.2X11 TCS+ MARUTEX</td> <td>6.000</td> <td>PZ</td> </tr> <tr> <td>VI1511A0</td> <td>RONDELLA PIANA 4.2x12x1 INOX</td> <td>1.000</td> <td>PZ</td> </tr> </tbody> </table>	Code	Description	Qty	UOM	GN1671A0	GUARNIZIONE RES 141x22 G8.5 ARMATA	1.000	PZ	RS1180A1	RESISTENZA 6 SPIRE 9 KW 230V	1.000	PZ	SL1045A0	SILICONE ANTRACITE S57 80 ml	1.000	PZ	VI1032A0	VITE M4X16 TCB+ INOX	1.000	PZ	VI1075A0	DADO M4 H=4 INOX UNI5587	1.000	PZ	VI1220A1	VITE AUTOFIL 4.2X11 TCS+ MARUTEX	6.000	PZ	VI1511A0	RONDELLA PIANA 4.2x12x1 INOX	1.000	PZ
Code	Description	Qty	UOM																																		
GN1671A0	GUARNIZIONE RES 141x22 G8.5 ARMATA	1.000	PZ																																		
RS1180A1	RESISTENZA 6 SPIRE 9 KW 230V	1.000	PZ																																		
SL1045A0	SILICONE ANTRACITE S57 80 ml	1.000	PZ																																		
VI1032A0	VITE M4X16 TCB+ INOX	1.000	PZ																																		
VI1075A0	DADO M4 H=4 INOX UNI5587	1.000	PZ																																		
VI1220A1	VITE AUTOFIL 4.2X11 TCS+ MARUTEX	6.000	PZ																																		
VI1511A0	RONDELLA PIANA 4.2x12x1 INOX	1.000	PZ																																		

COMPONENT			SPARE PART																														
Code	Description	Image	Code	Description	Kit components																												
GN1672A	GUARNIZIONE RS FRENATA		KGN1672A	71x19 HEATING ELEMENT GASKET 5 PCS KIT	<table border="1"> <thead> <tr> <th>Code</th> <th>Description</th> <th>Qty</th> <th>UOM</th> </tr> </thead> <tbody> <tr> <td>GN1672A1</td> <td>GUARNIZIONE RS FRENATA</td> <td>5.000</td> <td>PZ</td> </tr> </tbody> </table>	Code	Description	Qty	UOM	GN1672A1	GUARNIZIONE RS FRENATA	5.000	PZ																				
Code	Description	Qty	UOM																														
GN1672A1	GUARNIZIONE RS FRENATA	5.000	PZ																														
RS1215B	1 TURN 147W 105V FLAT ELEMENT		KRS1034A	MM 147W MOTOR BRAKING ELEMENT KIT	<table border="1"> <thead> <tr> <th>Code</th> <th>Description</th> <th>Qty</th> <th>UOM</th> </tr> </thead> <tbody> <tr> <td>GN1672A1</td> <td>GUARNIZIONE RS FRENATA</td> <td>1.000</td> <td>PZ</td> </tr> <tr> <td>RS1034A0</td> <td>RES PIANA 147W 105V 1 SPIRA CON CONCA</td> <td>1.000</td> <td>PZ</td> </tr> <tr> <td>SL1045A0</td> <td>SILICONE ANTRACITE S57 80 ml</td> <td>1.000</td> <td>PZ</td> </tr> <tr> <td>VI1220A1</td> <td>VITE AUTOFIL. 4.2X11 TCS+ MARUTEX</td> <td>2.000</td> <td>PZ</td> </tr> </tbody> </table>	Code	Description	Qty	UOM	GN1672A1	GUARNIZIONE RS FRENATA	1.000	PZ	RS1034A0	RES PIANA 147W 105V 1 SPIRA CON CONCA	1.000	PZ	SL1045A0	SILICONE ANTRACITE S57 80 ml	1.000	PZ	VI1220A1	VITE AUTOFIL. 4.2X11 TCS+ MARUTEX	2.000	PZ								
Code	Description	Qty	UOM																														
GN1672A1	GUARNIZIONE RS FRENATA	1.000	PZ																														
RS1034A0	RES PIANA 147W 105V 1 SPIRA CON CONCA	1.000	PZ																														
SL1045A0	SILICONE ANTRACITE S57 80 ml	1.000	PZ																														
VI1220A1	VITE AUTOFIL. 4.2X11 TCS+ MARUTEX	2.000	PZ																														
GN1285A	GUARNIZIONE SONDA DI TEMPERATURA NTC		KTR1106B	MIND.Maps L2000 CHAMBER TEMP. PROBE KIT	<table border="1"> <thead> <tr> <th>Code</th> <th>Description</th> <th>Qty</th> <th>UOM</th> </tr> </thead> <tbody> <tr> <td>GN1285A0</td> <td>GUARNIZIONE SONDA DI TEMPERATUR A NTC</td> <td>1.000</td> <td>PZ</td> </tr> <tr> <td>SL1045A0</td> <td>SILICONE ANTRACITE S57 80 ml</td> <td>1.000</td> <td>PZ</td> </tr> <tr> <td>TR1106B0</td> <td>SONDA TEMPERATUR A PT100 L2000</td> <td>1.000</td> <td>PZ</td> </tr> <tr> <td>VI1220A1</td> <td>VITE AUTOFIL. 4.2X11 TCS+ MARUTEX</td> <td>2.000</td> <td>PZ</td> </tr> <tr> <td>VM1464A1</td> <td>COPERCHIO SONDA TEMPERATUR A CT BT CON PA</td> <td>1.000</td> <td>PZ</td> </tr> <tr> <td>VM1465A1</td> <td>COPERCHIO SONDA TEMPERATUR A CT BT</td> <td>1.000</td> <td>PZ</td> </tr> </tbody> </table>	Code	Description	Qty	UOM	GN1285A0	GUARNIZIONE SONDA DI TEMPERATUR A NTC	1.000	PZ	SL1045A0	SILICONE ANTRACITE S57 80 ml	1.000	PZ	TR1106B0	SONDA TEMPERATUR A PT100 L2000	1.000	PZ	VI1220A1	VITE AUTOFIL. 4.2X11 TCS+ MARUTEX	2.000	PZ	VM1464A1	COPERCHIO SONDA TEMPERATUR A CT BT CON PA	1.000	PZ	VM1465A1	COPERCHIO SONDA TEMPERATUR A CT BT	1.000	PZ
Code	Description	Qty	UOM																														
GN1285A0	GUARNIZIONE SONDA DI TEMPERATUR A NTC	1.000	PZ																														
SL1045A0	SILICONE ANTRACITE S57 80 ml	1.000	PZ																														
TR1106B0	SONDA TEMPERATUR A PT100 L2000	1.000	PZ																														
VI1220A1	VITE AUTOFIL. 4.2X11 TCS+ MARUTEX	2.000	PZ																														
VM1464A1	COPERCHIO SONDA TEMPERATUR A CT BT CON PA	1.000	PZ																														
VM1465A1	COPERCHIO SONDA TEMPERATUR A CT BT	1.000	PZ																														
			KTR1106A	5-5E S. L2000 CHAMBER TEMP. PROBE KIT	<table border="1"> <thead> <tr> <th>Code</th> <th>Description</th> <th>Qty</th> <th>UOM</th> </tr> </thead> <tbody> <tr> <td>GN1285A0</td> <td>GUARNIZIONE SONDA DI TEMPERATUR A NTC</td> <td>1.000</td> <td>PZ</td> </tr> </tbody> </table>	Code	Description	Qty	UOM	GN1285A0	GUARNIZIONE SONDA DI TEMPERATUR A NTC	1.000	PZ																				
Code	Description	Qty	UOM																														
GN1285A0	GUARNIZIONE SONDA DI TEMPERATUR A NTC	1.000	PZ																														

COMPONENT			SPARE PART																																							
Code	Description	Image	Code	Description	Kit components																																					
GN1285A	GUARNIZIONE SONDA DI TEMPERATURA NTC		KTR1106A	5-5E S. L2000 CHAMBER TEMP. PROBE KIT	<table border="1"> <thead> <tr> <th>Code</th> <th>Description</th> <th>Qty</th> <th>UOM</th> </tr> </thead> <tbody> <tr> <td>SL1045A0</td> <td>SILICONE ANTRACITE S57 80 ml</td> <td>1.000</td> <td>PZ</td> </tr> <tr> <td>TR1106A3</td> <td>SONDA TEMPERATUR A PT100 L2000</td> <td>1.000</td> <td>PZ</td> </tr> <tr> <td>VI1220A1</td> <td>VITE AUTOFIL. 4.2X11 TCS+ MARUTEX</td> <td>2.000</td> <td>PZ</td> </tr> <tr> <td>VM1465A1</td> <td>COPERCHIO SONDA TEMPERATUR A CT BT</td> <td>1.000</td> <td>PZ</td> </tr> </tbody> </table>	Code	Description	Qty	UOM	SL1045A0	SILICONE ANTRACITE S57 80 ml	1.000	PZ	TR1106A3	SONDA TEMPERATUR A PT100 L2000	1.000	PZ	VI1220A1	VITE AUTOFIL. 4.2X11 TCS+ MARUTEX	2.000	PZ	VM1465A1	COPERCHIO SONDA TEMPERATUR A CT BT	1.000	PZ																	
			Code	Description	Qty	UOM																																				
			SL1045A0	SILICONE ANTRACITE S57 80 ml	1.000	PZ																																				
TR1106A3	SONDA TEMPERATUR A PT100 L2000	1.000	PZ																																							
VI1220A1	VITE AUTOFIL. 4.2X11 TCS+ MARUTEX	2.000	PZ																																							
VM1465A1	COPERCHIO SONDA TEMPERATUR A CT BT	1.000	PZ																																							
KTR1105A	PT100 L1000 TEMPERATURE PROBE KIT	<table border="1"> <thead> <tr> <th>Code</th> <th>Description</th> <th>Qty</th> <th>UOM</th> </tr> </thead> <tbody> <tr> <td>0H4302A0</td> <td>PIASTRINA SILICONE SONDE</td> <td>1.000</td> <td>PZ</td> </tr> <tr> <td>GN1120A1</td> <td>GUARNIZIONE SONDA TEMPERATUR A NTC LM</td> <td>1.000</td> <td>PZ</td> </tr> <tr> <td>GN1285A0</td> <td>GUARNIZIONE SONDA DI TEMPERATUR A NTC</td> <td>1.000</td> <td>PZ</td> </tr> <tr> <td>SL1045A0</td> <td>SILICONE ANTRACITE S57 80 ml</td> <td>1.000</td> <td>PZ</td> </tr> <tr> <td>TR1105A4</td> <td>SONDA TEMPERATUR A PT100 L1000</td> <td>1.000</td> <td>PZ</td> </tr> <tr> <td>VI1220A1</td> <td>VITE AUTOFIL. 4.2X11 TCS+ MARUTEX</td> <td>2.000</td> <td>PZ</td> </tr> <tr> <td>VM1464A1</td> <td>COPERCHIO SONDA TEMPERATUR A CT BT CON PA</td> <td>1.000</td> <td>PZ</td> </tr> <tr> <td>VM1465A1</td> <td>COPERCHIO SONDA TEMPERATUR A CT BT</td> <td>1.000</td> <td>PZ</td> </tr> <tr> <td>VM2052A0</td> <td>COPERCHIO SONDA TEMPERATUR A LM</td> <td>1.000</td> <td>PZ</td> </tr> </tbody> </table>	Code	Description	Qty	UOM	0H4302A0	PIASTRINA SILICONE SONDE	1.000	PZ	GN1120A1	GUARNIZIONE SONDA TEMPERATUR A NTC LM	1.000	PZ	GN1285A0	GUARNIZIONE SONDA DI TEMPERATUR A NTC	1.000	PZ	SL1045A0	SILICONE ANTRACITE S57 80 ml	1.000	PZ	TR1105A4	SONDA TEMPERATUR A PT100 L1000	1.000	PZ	VI1220A1	VITE AUTOFIL. 4.2X11 TCS+ MARUTEX	2.000	PZ	VM1464A1	COPERCHIO SONDA TEMPERATUR A CT BT CON PA	1.000	PZ	VM1465A1	COPERCHIO SONDA TEMPERATUR A CT BT	1.000	PZ	VM2052A0	COPERCHIO SONDA TEMPERATUR A LM	1.000	PZ
Code	Description	Qty	UOM																																							
0H4302A0	PIASTRINA SILICONE SONDE	1.000	PZ																																							
GN1120A1	GUARNIZIONE SONDA TEMPERATUR A NTC LM	1.000	PZ																																							
GN1285A0	GUARNIZIONE SONDA DI TEMPERATUR A NTC	1.000	PZ																																							
SL1045A0	SILICONE ANTRACITE S57 80 ml	1.000	PZ																																							
TR1105A4	SONDA TEMPERATUR A PT100 L1000	1.000	PZ																																							
VI1220A1	VITE AUTOFIL. 4.2X11 TCS+ MARUTEX	2.000	PZ																																							
VM1464A1	COPERCHIO SONDA TEMPERATUR A CT BT CON PA	1.000	PZ																																							
VM1465A1	COPERCHIO SONDA TEMPERATUR A CT BT	1.000	PZ																																							
VM2052A0	COPERCHIO SONDA TEMPERATUR A LM	1.000	PZ																																							
KTR1096A	NTC 150 L=1500 TEMPERATURE PROBE KIT	<table border="1"> <thead> <tr> <th>Code</th> <th>Description</th> <th>Qty</th> <th>UOM</th> </tr> </thead> <tbody> <tr> <td>GN1120A1</td> <td>GUARNIZIONE SONDA TEMPERATUR A NTC LM</td> <td>1.000</td> <td>PZ</td> </tr> </tbody> </table>	Code	Description	Qty	UOM	GN1120A1	GUARNIZIONE SONDA TEMPERATUR A NTC LM	1.000	PZ																																
Code	Description	Qty	UOM																																							
GN1120A1	GUARNIZIONE SONDA TEMPERATUR A NTC LM	1.000	PZ																																							



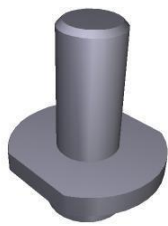

COMPONENT			SPARE PART																											
Code	Description	Image	Code	Description	Kit components																									
GN1285A	GUARNIZIONE SONDA DI TEMPERATURA NTC		KTR1096A	NTC 150 L=1500 TEMPERATURE PROBE KIT	<table border="1"> <thead> <tr> <th>Code</th> <th>Description</th> <th>Qty</th> <th>UOM</th> </tr> </thead> <tbody> <tr> <td>GN1285A0</td> <td>GUARNIZIONE SONDA DI TEMPERATUR A NTC</td> <td>2.000</td> <td>PZ</td> </tr> <tr> <td>SL1045A0</td> <td>SILICONE ANTRACITE S57 80 ml</td> <td>1.000</td> <td>PZ</td> </tr> <tr> <td>TR1096A0</td> <td>SONDA TEMPERATUR A NTC 150 L=1500</td> <td>1.000</td> <td>PZ</td> </tr> <tr> <td>VI1220A1</td> <td>VITE AUTOFIL. 4.2X11 TCS+ MARUTEX</td> <td>2.000</td> <td>PZ</td> </tr> <tr> <td>VM1465A1</td> <td>COPERCHIO SONDA TEMPERATUR A CT BT</td> <td>1.000</td> <td>PZ</td> </tr> </tbody> </table>	Code	Description	Qty	UOM	GN1285A0	GUARNIZIONE SONDA DI TEMPERATUR A NTC	2.000	PZ	SL1045A0	SILICONE ANTRACITE S57 80 ml	1.000	PZ	TR1096A0	SONDA TEMPERATUR A NTC 150 L=1500	1.000	PZ	VI1220A1	VITE AUTOFIL. 4.2X11 TCS+ MARUTEX	2.000	PZ	VM1465A1	COPERCHIO SONDA TEMPERATUR A CT BT	1.000	PZ	
			Code	Description	Qty	UOM																								
			GN1285A0	GUARNIZIONE SONDA DI TEMPERATUR A NTC	2.000	PZ																								
SL1045A0	SILICONE ANTRACITE S57 80 ml	1.000	PZ																											
TR1096A0	SONDA TEMPERATUR A NTC 150 L=1500	1.000	PZ																											
VI1220A1	VITE AUTOFIL. 4.2X11 TCS+ MARUTEX	2.000	PZ																											
VM1465A1	COPERCHIO SONDA TEMPERATUR A CT BT	1.000	PZ																											
KTR1095A	NTC 150 L=1050 TEMPERATURE PROBE KIT	<table border="1"> <thead> <tr> <th>Code</th> <th>Description</th> <th>Qty</th> <th>UOM</th> </tr> </thead> <tbody> <tr> <td>GN1120A1</td> <td>GUARNIZIONE SONDA TEMPERATUR A NTC LM</td> <td>1.000</td> <td>PZ</td> </tr> <tr> <td>GN1285A0</td> <td>GUARNIZIONE SONDA DI TEMPERATUR A NTC</td> <td>1.000</td> <td>PZ</td> </tr> <tr> <td>SL1045A0</td> <td>SILICONE ANTRACITE S57 80 ml</td> <td>1.000</td> <td>PZ</td> </tr> <tr> <td>TR1095A0</td> <td>SONDA TEMPERATUR A NTC 150 L=1050</td> <td>1.000</td> <td>PZ</td> </tr> <tr> <td>VI1220A1</td> <td>VITE AUTOFIL. 4.2X11 TCS+ MARUTEX</td> <td>2.000</td> <td>PZ</td> </tr> <tr> <td>VM1465A1</td> <td>COPERCHIO SONDA TEMPERATUR A CT BT</td> <td>1.000</td> <td>PZ</td> </tr> </tbody> </table>	Code	Description	Qty	UOM	GN1120A1	GUARNIZIONE SONDA TEMPERATUR A NTC LM	1.000	PZ	GN1285A0	GUARNIZIONE SONDA DI TEMPERATUR A NTC	1.000	PZ	SL1045A0	SILICONE ANTRACITE S57 80 ml	1.000	PZ	TR1095A0	SONDA TEMPERATUR A NTC 150 L=1050	1.000	PZ	VI1220A1	VITE AUTOFIL. 4.2X11 TCS+ MARUTEX	2.000	PZ	VM1465A1	COPERCHIO SONDA TEMPERATUR A CT BT	1.000	PZ
Code	Description	Qty	UOM																											
GN1120A1	GUARNIZIONE SONDA TEMPERATUR A NTC LM	1.000	PZ																											
GN1285A0	GUARNIZIONE SONDA DI TEMPERATUR A NTC	1.000	PZ																											
SL1045A0	SILICONE ANTRACITE S57 80 ml	1.000	PZ																											
TR1095A0	SONDA TEMPERATUR A NTC 150 L=1050	1.000	PZ																											
VI1220A1	VITE AUTOFIL. 4.2X11 TCS+ MARUTEX	2.000	PZ																											
VM1465A1	COPERCHIO SONDA TEMPERATUR A CT BT	1.000	PZ																											
KTR1002A	PT100 L1000 UL TEMPERATURE PROBE KIT	<table border="1"> <thead> <tr> <th>Code</th> <th>Description</th> <th>Qty</th> <th>UOM</th> </tr> </thead> <tbody> <tr> <td>GN1285A0</td> <td>GUARNIZIONE SONDA DI TEMPERATUR A NTC</td> <td>2.000</td> <td>PZ</td> </tr> <tr> <td>SL1045A0</td> <td>SILICONE ANTRACITE S57 80 ml</td> <td>1.000</td> <td>PZ</td> </tr> <tr> <td>TR1002A1</td> <td>SONDA TEMPERATUR A UL PT100 L1000</td> <td>1.000</td> <td>PZ</td> </tr> </tbody> </table>	Code	Description	Qty	UOM	GN1285A0	GUARNIZIONE SONDA DI TEMPERATUR A NTC	2.000	PZ	SL1045A0	SILICONE ANTRACITE S57 80 ml	1.000	PZ	TR1002A1	SONDA TEMPERATUR A UL PT100 L1000	1.000	PZ												
Code	Description	Qty	UOM																											
GN1285A0	GUARNIZIONE SONDA DI TEMPERATUR A NTC	2.000	PZ																											
SL1045A0	SILICONE ANTRACITE S57 80 ml	1.000	PZ																											
TR1002A1	SONDA TEMPERATUR A UL PT100 L1000	1.000	PZ																											





COMPONENT			SPARE PART																														
Code	Description	Image	Code	Description	Kit components																												
GN1285A	GUARNIZIONE SONDA DI TEMPERATURA NTC		KTR1002A	PT100 L1000 UL TEMPERATURE PROBE KIT	<table border="1"> <thead> <tr> <th>Code</th> <th>Description</th> <th>Qty</th> <th>UOM</th> </tr> </thead> <tbody> <tr> <td>VH1220A1</td> <td>VITE AUTOFIL. 4.2X11 TCS+ MARUTEX</td> <td>2.000</td> <td>PZ</td> </tr> <tr> <td>VM1465A1</td> <td>COPERCHIO SONDA TEMPERATUR A CT BT</td> <td>1.000</td> <td>PZ</td> </tr> </tbody> </table>	Code	Description	Qty	UOM	VH1220A1	VITE AUTOFIL. 4.2X11 TCS+ MARUTEX	2.000	PZ	VM1465A1	COPERCHIO SONDA TEMPERATUR A CT BT	1.000	PZ																
Code	Description	Qty	UOM																														
VH1220A1	VITE AUTOFIL. 4.2X11 TCS+ MARUTEX	2.000	PZ																														
VM1465A1	COPERCHIO SONDA TEMPERATUR A CT BT	1.000	PZ																														
TR1106B	SONDA TEMPERATURA PT100 L2000		KTR1106B	MIND.Maps L2000 CHAMBER TEMP. PROBE KIT	<table border="1"> <thead> <tr> <th>Code</th> <th>Description</th> <th>Qty</th> <th>UOM</th> </tr> </thead> <tbody> <tr> <td>GN1285A0</td> <td>GUARNIZIONE SONDA DI TEMPERATUR A NTC</td> <td>1.000</td> <td>PZ</td> </tr> <tr> <td>SL1045A0</td> <td>SILICONE ANTRACITE S57 80 ml</td> <td>1.000</td> <td>PZ</td> </tr> <tr> <td>TR1106B0</td> <td>SONDA TEMPERATUR A PT100 L2000</td> <td>1.000</td> <td>PZ</td> </tr> <tr> <td>VH1220A1</td> <td>VITE AUTOFIL. 4.2X11 TCS+ MARUTEX</td> <td>2.000</td> <td>PZ</td> </tr> <tr> <td>VM1464A1</td> <td>COPERCHIO SONDA TEMPERATUR A CT BT CON PA</td> <td>1.000</td> <td>PZ</td> </tr> <tr> <td>VM1465A1</td> <td>COPERCHIO SONDA TEMPERATUR A CT BT</td> <td>1.000</td> <td>PZ</td> </tr> </tbody> </table>	Code	Description	Qty	UOM	GN1285A0	GUARNIZIONE SONDA DI TEMPERATUR A NTC	1.000	PZ	SL1045A0	SILICONE ANTRACITE S57 80 ml	1.000	PZ	TR1106B0	SONDA TEMPERATUR A PT100 L2000	1.000	PZ	VH1220A1	VITE AUTOFIL. 4.2X11 TCS+ MARUTEX	2.000	PZ	VM1464A1	COPERCHIO SONDA TEMPERATUR A CT BT CON PA	1.000	PZ	VM1465A1	COPERCHIO SONDA TEMPERATUR A CT BT	1.000	PZ
Code	Description	Qty	UOM																														
GN1285A0	GUARNIZIONE SONDA DI TEMPERATUR A NTC	1.000	PZ																														
SL1045A0	SILICONE ANTRACITE S57 80 ml	1.000	PZ																														
TR1106B0	SONDA TEMPERATUR A PT100 L2000	1.000	PZ																														
VH1220A1	VITE AUTOFIL. 4.2X11 TCS+ MARUTEX	2.000	PZ																														
VM1464A1	COPERCHIO SONDA TEMPERATUR A CT BT CON PA	1.000	PZ																														
VM1465A1	COPERCHIO SONDA TEMPERATUR A CT BT	1.000	PZ																														
VM1464A	COPERCHIO SONDA TEMPERATURA CT BT CON PA		KVM1464A	CT BT TEMPERATURE PROBE COVER KIT	<table border="1"> <thead> <tr> <th>Code</th> <th>Description</th> <th>Qty</th> <th>UOM</th> </tr> </thead> <tbody> <tr> <td>VM1464A1</td> <td>COPERCHIO SONDA TEMPERATUR A CT BT CON PA</td> <td>1.000</td> <td>PZ</td> </tr> </tbody> </table>	Code	Description	Qty	UOM	VM1464A1	COPERCHIO SONDA TEMPERATUR A CT BT CON PA	1.000	PZ																				
Code	Description	Qty	UOM																														
VM1464A1	COPERCHIO SONDA TEMPERATUR A CT BT CON PA	1.000	PZ																														
GN1588A	GUARNIZIONE RESISTENZA 78x28 G6.25		KGN1588A	HEATING ELEMENT 78x28 GASKET 2PCS KIT	<table border="1"> <thead> <tr> <th>Code</th> <th>Description</th> <th>Qty</th> <th>UOM</th> </tr> </thead> <tbody> <tr> <td>GN1588A0</td> <td>GUARNIZIONE RESISTENZA 78x28 G6.25</td> <td>2.000</td> <td>PZ</td> </tr> </tbody> </table>	Code	Description	Qty	UOM	GN1588A0	GUARNIZIONE RESISTENZA 78x28 G6.25	2.000	PZ																				
Code	Description	Qty	UOM																														
GN1588A0	GUARNIZIONE RESISTENZA 78x28 G6.25	2.000	PZ																														

COMPONENT			SPARE PART																						
Code	Description	Image	Code	Description	Kit components																				
RS1277A	RES. PIEGATA 100W 60V 1 SPIRA PIEGATA SM		KRS1277A	100W 60V SMOKER ELEMENT KIT	<table border="1"> <thead> <tr> <th>Code</th> <th>Description</th> <th>Qty</th> <th>UOM</th> </tr> </thead> <tbody> <tr> <td>GN1588A0</td> <td>GUARNIZIONE RESISTENZA 78x28 G6.25</td> <td>1.000</td> <td>PZ</td> </tr> <tr> <td>RS1277A0</td> <td>RES. PIEGATA 100W 60V 1 SPIRA PIEGATA SM</td> <td>1.000</td> <td>PZ</td> </tr> <tr> <td>SL1045A0</td> <td>SILICONE ANTRACITE S57 80 ml</td> <td>1.000</td> <td>PZ</td> </tr> <tr> <td>VI1220A1</td> <td>VITE AUTOFIL. 4.2X11 TCS+ MARUTEX</td> <td>2.000</td> <td>PZ</td> </tr> </tbody> </table>	Code	Description	Qty	UOM	GN1588A0	GUARNIZIONE RESISTENZA 78x28 G6.25	1.000	PZ	RS1277A0	RES. PIEGATA 100W 60V 1 SPIRA PIEGATA SM	1.000	PZ	SL1045A0	SILICONE ANTRACITE S57 80 ml	1.000	PZ	VI1220A1	VITE AUTOFIL. 4.2X11 TCS+ MARUTEX	2.000	PZ
					Code	Description	Qty	UOM																	
					GN1588A0	GUARNIZIONE RESISTENZA 78x28 G6.25	1.000	PZ																	
					RS1277A0	RES. PIEGATA 100W 60V 1 SPIRA PIEGATA SM	1.000	PZ																	
SL1045A0	SILICONE ANTRACITE S57 80 ml	1.000	PZ																						
VI1220A1	VITE AUTOFIL. 4.2X11 TCS+ MARUTEX	2.000	PZ																						
VM2416A	SMOKER LOCKING GUIDE PIN		VM2416A0	SMOKER LOCKING GUIDE PIN																					
0H4305A	ST. STEEL MOTOR SHAFT SEALING DIS		K0H4305A	SEALING DISC FOR MOTOR SHAFT KIT	<table border="1"> <thead> <tr> <th>Code</th> <th>Description</th> <th>Qty</th> <th>UOM</th> </tr> </thead> <tbody> <tr> <td>0H8118A0</td> <td>DISCO TENUTA ALBERO MOTORE XEVL</td> <td>1.000</td> <td>PZ</td> </tr> <tr> <td>GN1140A3</td> <td>GUARNIZIONE PORTAMOTO RE STAMPAT</td> <td>1.000</td> <td>PZ</td> </tr> <tr> <td>SL1045A0</td> <td>SILICONE ANTRACITE S57 80 ml</td> <td>1.000</td> <td>PZ</td> </tr> <tr> <td>VI1220A1</td> <td>VITE AUTOFIL. 4.2X11 TCS+ MARUTEX</td> <td>3.000</td> <td>PZ</td> </tr> </tbody> </table>	Code	Description	Qty	UOM	0H8118A0	DISCO TENUTA ALBERO MOTORE XEVL	1.000	PZ	GN1140A3	GUARNIZIONE PORTAMOTO RE STAMPAT	1.000	PZ	SL1045A0	SILICONE ANTRACITE S57 80 ml	1.000	PZ	VI1220A1	VITE AUTOFIL. 4.2X11 TCS+ MARUTEX	3.000	PZ
					Code	Description	Qty	UOM																	
					0H8118A0	DISCO TENUTA ALBERO MOTORE XEVL	1.000	PZ																	
					GN1140A3	GUARNIZIONE PORTAMOTO RE STAMPAT	1.000	PZ																	
SL1045A0	SILICONE ANTRACITE S57 80 ml	1.000	PZ																						
VI1220A1	VITE AUTOFIL. 4.2X11 TCS+ MARUTEX	3.000	PZ																						
0H7170A	MM MOTOR GLASS WOOL PLATE		0H7170A0	MM MOTOR GLASS WOOL PLATE																					

COMPONENT			SPARE PART																																						
Code	Description	Image	Code	Description	Kit components																																				
GN1140A	GUARNIZIONE PORTAMOTORE STAMPATO		KGN1140A	5 PCS. MOTOR HOLDER GASKET KI	<table border="1"> <thead> <tr> <th>Code</th> <th>Description</th> <th>Qty</th> <th>UOM</th> </tr> </thead> <tbody> <tr> <td>GN1140A3</td> <td>GUARNIZIONE PORTAMOTO RE STAMPAT</td> <td>5.000</td> <td>PZ</td> </tr> </tbody> </table>	Code	Description	Qty	UOM	GN1140A3	GUARNIZIONE PORTAMOTO RE STAMPAT	5.000	PZ																												
Code	Description	Qty	UOM																																						
GN1140A3	GUARNIZIONE PORTAMOTO RE STAMPAT	5.000	PZ																																						
MT1012A	MOTORE SIMMETRICO 330W 230V ALBERO D12		KVN1130A	LUX ≤08.2017/L.MISS/S.5/ 5E MOTOR KIT	<table border="1"> <thead> <tr> <th>Code</th> <th>Description</th> <th>Qty</th> <th>UOM</th> </tr> </thead> <tbody> <tr> <td>0H8118A0</td> <td>DISCO TENUTA ALBERO MOTORE XEVL</td> <td>1.000</td> <td>PZ</td> </tr> <tr> <td>GN1140A3</td> <td>GUARNIZIONE PORTAMOTO RE STAMPAT</td> <td>1.000</td> <td>PZ</td> </tr> <tr> <td>V11034A0</td> <td>RONDELLA PIANA 8.4x16x1 INOX</td> <td>1.000</td> <td>PZ</td> </tr> <tr> <td>V11256A0</td> <td>DADO M8 DIN 980M AUTOBLOCCA NTE INOX</td> <td>1.000</td> <td>PZ</td> </tr> <tr> <td>VM2196A0</td> <td>BOCCOLA FISSAGGIO DADO MOTOR</td> <td>1.000</td> <td>PZ</td> </tr> <tr> <td>VN1130A1</td> <td>MOTORE FORNO 330W 230V 50/60Hz ALBERO M8</td> <td>1.000</td> <td>PZ</td> </tr> </tbody> </table>	Code	Description	Qty	UOM	0H8118A0	DISCO TENUTA ALBERO MOTORE XEVL	1.000	PZ	GN1140A3	GUARNIZIONE PORTAMOTO RE STAMPAT	1.000	PZ	V11034A0	RONDELLA PIANA 8.4x16x1 INOX	1.000	PZ	V11256A0	DADO M8 DIN 980M AUTOBLOCCA NTE INOX	1.000	PZ	VM2196A0	BOCCOLA FISSAGGIO DADO MOTOR	1.000	PZ	VN1130A1	MOTORE FORNO 330W 230V 50/60Hz ALBERO M8	1.000	PZ								
Code	Description	Qty	UOM																																						
0H8118A0	DISCO TENUTA ALBERO MOTORE XEVL	1.000	PZ																																						
GN1140A3	GUARNIZIONE PORTAMOTO RE STAMPAT	1.000	PZ																																						
V11034A0	RONDELLA PIANA 8.4x16x1 INOX	1.000	PZ																																						
V11256A0	DADO M8 DIN 980M AUTOBLOCCA NTE INOX	1.000	PZ																																						
VM2196A0	BOCCOLA FISSAGGIO DADO MOTOR	1.000	PZ																																						
VN1130A1	MOTORE FORNO 330W 230V 50/60Hz ALBERO M8	1.000	PZ																																						
			KMT1012A	LUX >08.2017 / MIND.MAPS 330W MOTOR KIT	<table border="1"> <thead> <tr> <th>Code</th> <th>Description</th> <th>Qty</th> <th>UOM</th> </tr> </thead> <tbody> <tr> <td>0H2842A0</td> <td>MASCHERA CENTRAGGIO MT1012</td> <td>1.000</td> <td>PZ</td> </tr> <tr> <td>0H8118A0</td> <td>DISCO TENUTA ALBERO MOTORE XEVL</td> <td>1.000</td> <td>PZ</td> </tr> <tr> <td>GN1140A3</td> <td>GUARNIZIONE PORTAMOTO RE STAMPAT</td> <td>1.000</td> <td>PZ</td> </tr> <tr> <td>MT1012A0</td> <td>MOTORE SIMMETRICO 330W 230V ALBERO D12</td> <td>1.000</td> <td>PZ</td> </tr> <tr> <td>V11077A1</td> <td>VITE M6x12 TE INOX</td> <td>1.000</td> <td>PZ</td> </tr> <tr> <td>V11521A0</td> <td>RONDELLA PIANA 6x12x1 INOX</td> <td>1.000</td> <td>PZ</td> </tr> <tr> <td>V11966A1</td> <td>VITE M4X14 TSP+ ZN</td> <td>1.000</td> <td>PZ</td> </tr> <tr> <td>VM2880A0</td> <td>ASM MGT MISURA NUMERO GIRI</td> <td>1.000</td> <td>PZ</td> </tr> </tbody> </table>	Code	Description	Qty	UOM	0H2842A0	MASCHERA CENTRAGGIO MT1012	1.000	PZ	0H8118A0	DISCO TENUTA ALBERO MOTORE XEVL	1.000	PZ	GN1140A3	GUARNIZIONE PORTAMOTO RE STAMPAT	1.000	PZ	MT1012A0	MOTORE SIMMETRICO 330W 230V ALBERO D12	1.000	PZ	V11077A1	VITE M6x12 TE INOX	1.000	PZ	V11521A0	RONDELLA PIANA 6x12x1 INOX	1.000	PZ	V11966A1	VITE M4X14 TSP+ ZN	1.000	PZ	VM2880A0	ASM MGT MISURA NUMERO GIRI	1.000	PZ
Code	Description	Qty	UOM																																						
0H2842A0	MASCHERA CENTRAGGIO MT1012	1.000	PZ																																						
0H8118A0	DISCO TENUTA ALBERO MOTORE XEVL	1.000	PZ																																						
GN1140A3	GUARNIZIONE PORTAMOTO RE STAMPAT	1.000	PZ																																						
MT1012A0	MOTORE SIMMETRICO 330W 230V ALBERO D12	1.000	PZ																																						
V11077A1	VITE M6x12 TE INOX	1.000	PZ																																						
V11521A0	RONDELLA PIANA 6x12x1 INOX	1.000	PZ																																						
V11966A1	VITE M4X14 TSP+ ZN	1.000	PZ																																						
VM2880A0	ASM MGT MISURA NUMERO GIRI	1.000	PZ																																						





COMPONENT			SPARE PART																						
Code	Description	Image	Code	Description	Kit components																				
VN1170B	D195 H80 8 BLADES FAN+RING		KVN1184A	D195 H80 8 CONCAVE BLADES FAN KIT	<table border="1"> <thead> <tr> <th>Code</th> <th>Description</th> <th>Qty</th> <th>UOM</th> </tr> </thead> <tbody> <tr> <td>VH1122A0</td> <td>VITE M6X12 TE INOX A4 316</td> <td>1.000</td> <td>PZ</td> </tr> <tr> <td>VH1123A0</td> <td>RONDELLA PIANA M6 INOX A4 AISI316</td> <td>1.000</td> <td>PZ</td> </tr> <tr> <td>VN1184A0</td> <td>VENTOLA D195 H80 PALE SCARICATE</td> <td>1.000</td> <td>PZ</td> </tr> </tbody> </table>	Code	Description	Qty	UOM	VH1122A0	VITE M6X12 TE INOX A4 316	1.000	PZ	VH1123A0	RONDELLA PIANA M6 INOX A4 AISI316	1.000	PZ	VN1184A0	VENTOLA D195 H80 PALE SCARICATE	1.000	PZ				
Code	Description	Qty	UOM																						
VH1122A0	VITE M6X12 TE INOX A4 316	1.000	PZ																						
VH1123A0	RONDELLA PIANA M6 INOX A4 AISI316	1.000	PZ																						
VN1184A0	VENTOLA D195 H80 PALE SCARICATE	1.000	PZ																						
0G1549C	CARTER COMPLETO CON ALETTE XEVC-0511-		K0G1549C	XEVC-0511-E COMPLETE FAN GUARD KIT	<table border="1"> <thead> <tr> <th>Code</th> <th>Description</th> <th>Qty</th> <th>UOM</th> </tr> </thead> <tbody> <tr> <td>0G1549C1</td> <td>CARTER COMPLETO CON ALETTE XEVC-0511-E</td> <td>1.000</td> <td>PZ</td> </tr> <tr> <td>TB2951B0</td> <td>TUBO INTERNO UMIDITA XEVC-0511-E</td> <td>1.000</td> <td>PZ</td> </tr> <tr> <td>VH1220A1</td> <td>VITE AUTOFIL. 4.2X11 TCS+ MARUTEX</td> <td>2.000</td> <td>PZ</td> </tr> </tbody> </table>	Code	Description	Qty	UOM	0G1549C1	CARTER COMPLETO CON ALETTE XEVC-0511-E	1.000	PZ	TB2951B0	TUBO INTERNO UMIDITA XEVC-0511-E	1.000	PZ	VH1220A1	VITE AUTOFIL. 4.2X11 TCS+ MARUTEX	2.000	PZ				
Code	Description	Qty	UOM																						
0G1549C1	CARTER COMPLETO CON ALETTE XEVC-0511-E	1.000	PZ																						
TB2951B0	TUBO INTERNO UMIDITA XEVC-0511-E	1.000	PZ																						
VH1220A1	VITE AUTOFIL. 4.2X11 TCS+ MARUTEX	2.000	PZ																						
TB2951B	TUBO INTERNO UMIDITA XEVC-0511-E		TB2951B0	TUBO INTERNO UMIDITA XEVC-0511-E																					
SN1000B	L1550 STR MULTI.POINT CORE PROBE W/O NUT		KSN1000B	MULTIPOINT CORE PROBE KIT L1550	<table border="1"> <thead> <tr> <th>Code</th> <th>Description</th> <th>Qty</th> <th>UOM</th> </tr> </thead> <tbody> <tr> <td>0H8119A0</td> <td>COPERCHIO INGRESSO SONDA CUORE XEVL 316</td> <td>1.000</td> <td>PZ</td> </tr> <tr> <td>CE1685A0</td> <td>MORSETTO FEMMINA ESTR. MRT8 P3,81 5P</td> <td>1.000</td> <td>PZ</td> </tr> <tr> <td>GN1632A0</td> <td>GUARNIZIONE TENUTA INGRESSO SONDA-CUOR</td> <td>1.000</td> <td>PZ</td> </tr> <tr> <td>SL1045A0</td> <td>SILICONE ANTRACITE S57 80 ml</td> <td>1.000</td> <td>PZ</td> </tr> </tbody> </table>	Code	Description	Qty	UOM	0H8119A0	COPERCHIO INGRESSO SONDA CUORE XEVL 316	1.000	PZ	CE1685A0	MORSETTO FEMMINA ESTR. MRT8 P3,81 5P	1.000	PZ	GN1632A0	GUARNIZIONE TENUTA INGRESSO SONDA-CUOR	1.000	PZ	SL1045A0	SILICONE ANTRACITE S57 80 ml	1.000	PZ
Code	Description	Qty	UOM																						
0H8119A0	COPERCHIO INGRESSO SONDA CUORE XEVL 316	1.000	PZ																						
CE1685A0	MORSETTO FEMMINA ESTR. MRT8 P3,81 5P	1.000	PZ																						
GN1632A0	GUARNIZIONE TENUTA INGRESSO SONDA-CUOR	1.000	PZ																						
SL1045A0	SILICONE ANTRACITE S57 80 ml	1.000	PZ																						

COMPONENT			SPARE PART																										
Code	Description	Image	Code	Description	Kit components																								
SN1000B	L1550 STR MULTI.POINT CORE PROBE W/O NUT		KSN1000B	MULTIPOINT CORE PROBE KIT L1550	<table border="1"> <thead> <tr> <th>Code</th> <th>Description</th> <th>Qty</th> <th>UOM</th> </tr> </thead> <tbody> <tr> <td>SN1000B1</td> <td>SONDA CUORE MULTIPUNTO L1550 NO RACCORDO</td> <td>1.000</td> <td>PZ</td> </tr> <tr> <td>VI1220A1</td> <td>VITE AUTOFIL. 4.2X11 TCS+ MARUTEX</td> <td>3.000</td> <td>PZ</td> </tr> </tbody> </table>	Code	Description	Qty	UOM	SN1000B1	SONDA CUORE MULTIPUNTO L1550 NO RACCORDO	1.000	PZ	VI1220A1	VITE AUTOFIL. 4.2X11 TCS+ MARUTEX	3.000	PZ												
					Code	Description	Qty	UOM																					
SN1000B1	SONDA CUORE MULTIPUNTO L1550 NO RACCORDO	1.000	PZ																										
VI1220A1	VITE AUTOFIL. 4.2X11 TCS+ MARUTEX	3.000	PZ																										
GRL1389A	SUPPORTO LAT. DX 5 GN1/1 0511		KGRL1390A	MIND.Maps 5 GN1/1 LATERAL SUPPORTS KIT	<table border="1"> <thead> <tr> <th>Code</th> <th>Description</th> <th>Qty</th> <th>UOM</th> </tr> </thead> <tbody> <tr> <td>GRL1389A2</td> <td>SUPPORTO LAT. DX 5 GN1/1 0511</td> <td>1.000</td> <td>PZ</td> </tr> <tr> <td>GRL1390A2</td> <td>SUPPORTO LAT. SX 5 GN1/1 0511</td> <td>1.000</td> <td>PZ</td> </tr> </tbody> </table>	Code	Description	Qty	UOM	GRL1389A2	SUPPORTO LAT. DX 5 GN1/1 0511	1.000	PZ	GRL1390A2	SUPPORTO LAT. SX 5 GN1/1 0511	1.000	PZ												
Code	Description	Qty	UOM																										
GRL1389A2	SUPPORTO LAT. DX 5 GN1/1 0511	1.000	PZ																										
GRL1390A2	SUPPORTO LAT. SX 5 GN1/1 0511	1.000	PZ																										
GRL1390A	SUPPORTO LAT. SX 5 GN1/1 0511		KGRL1390A	MIND.Maps 5 GN1/1 LATERAL SUPPORTS KIT	<table border="1"> <thead> <tr> <th>Code</th> <th>Description</th> <th>Qty</th> <th>UOM</th> </tr> </thead> <tbody> <tr> <td>GRL1389A2</td> <td>SUPPORTO LAT. DX 5 GN1/1 0511</td> <td>1.000</td> <td>PZ</td> </tr> <tr> <td>GRL1390A2</td> <td>SUPPORTO LAT. SX 5 GN1/1 0511</td> <td>1.000</td> <td>PZ</td> </tr> </tbody> </table>	Code	Description	Qty	UOM	GRL1389A2	SUPPORTO LAT. DX 5 GN1/1 0511	1.000	PZ	GRL1390A2	SUPPORTO LAT. SX 5 GN1/1 0511	1.000	PZ												
Code	Description	Qty	UOM																										
GRL1389A2	SUPPORTO LAT. DX 5 GN1/1 0511	1.000	PZ																										
GRL1390A2	SUPPORTO LAT. SX 5 GN1/1 0511	1.000	PZ																										
GN1584A	RACCORDO ANGOLARE D30-D16		KG1584A	D30-D16 CORNER FITTING KIT	<table border="1"> <thead> <tr> <th>Code</th> <th>Description</th> <th>Qty</th> <th>UOM</th> </tr> </thead> <tbody> <tr> <td>GN1584A0</td> <td>RACCORDO ANGOLARE D30-D16</td> <td>1.000</td> <td>PZ</td> </tr> </tbody> </table>	Code	Description	Qty	UOM	GN1584A0	RACCORDO ANGOLARE D30-D16	1.000	PZ																
Code	Description	Qty	UOM																										
GN1584A0	RACCORDO ANGOLARE D30-D16	1.000	PZ																										
RC1042A	FASCETTA BIFILARE A MOLLA D21.5-22.6 TUB		KTB3074B	XEVC-0711-G VENTURI COLLECTOR PIPE KI	<table border="1"> <thead> <tr> <th>Code</th> <th>Description</th> <th>Qty</th> <th>UOM</th> </tr> </thead> <tbody> <tr> <td>GN1544A0</td> <td>GUARNIZIONE INGRESSO ARI</td> <td>1.000</td> <td>PZ</td> </tr> <tr> <td>GN1584A0</td> <td>RACCORDO ANGOLARE D30-D16</td> <td>1.000</td> <td>PZ</td> </tr> <tr> <td>RC1042A0</td> <td>FASCETTA BIFILARE A MOLLA D21.5-22.6 TUB</td> <td>1.000</td> <td>PZ</td> </tr> <tr> <td>TB3074B0</td> <td>TUBO D30 COLLETTORE VENTURI XEVC-07EU-G</td> <td>1.000</td> <td>PZ</td> </tr> <tr> <td>VM1794A0</td> <td>FASCETTA 430X4.8 PA66 NERA</td> <td>1.000</td> <td>PZ</td> </tr> </tbody> </table>	Code	Description	Qty	UOM	GN1544A0	GUARNIZIONE INGRESSO ARI	1.000	PZ	GN1584A0	RACCORDO ANGOLARE D30-D16	1.000	PZ	RC1042A0	FASCETTA BIFILARE A MOLLA D21.5-22.6 TUB	1.000	PZ	TB3074B0	TUBO D30 COLLETTORE VENTURI XEVC-07EU-G	1.000	PZ	VM1794A0	FASCETTA 430X4.8 PA66 NERA	1.000	PZ
					Code	Description	Qty	UOM																					
					GN1544A0	GUARNIZIONE INGRESSO ARI	1.000	PZ																					
					GN1584A0	RACCORDO ANGOLARE D30-D16	1.000	PZ																					
					RC1042A0	FASCETTA BIFILARE A MOLLA D21.5-22.6 TUB	1.000	PZ																					
TB3074B0	TUBO D30 COLLETTORE VENTURI XEVC-07EU-G	1.000	PZ																										
VM1794A0	FASCETTA 430X4.8 PA66 NERA	1.000	PZ																										

COMPONENT			SPARE PART																										
Code	Description	Image	Code	Description	Kit components																								
RC1042A	FASCETTA BIFILARE A MOLLA D21.5-22.6 TUB		KTB3068B	10FS/EU/2-G VENTURI COLLECTOR PIPE KI	<table border="1"> <thead> <tr> <th>Code</th> <th>Description</th> <th>Qty</th> <th>UOM</th> </tr> </thead> <tbody> <tr> <td>GN1544A0</td> <td>GUARNIZIONE INGRESSO ARI</td> <td>2.000</td> <td>PZ</td> </tr> <tr> <td>GN1584A0</td> <td>RACCORDO ANGOLARE D30-D16</td> <td>1.000</td> <td>PZ</td> </tr> <tr> <td>RC1042A0</td> <td>FASCETTA BIFILARE A MOLLA D21.5-22.6 TUB</td> <td>1.000</td> <td>PZ</td> </tr> <tr> <td>TB3068B0</td> <td>TUBO D30 COLLETTORE ARIA VENTURI XEBC-10</td> <td>1.000</td> <td>PZ</td> </tr> <tr> <td>VM1794A0</td> <td>FASCETTA 430X4.8 PA66 NERA</td> <td>1.000</td> <td>PZ</td> </tr> </tbody> </table>	Code	Description	Qty	UOM	GN1544A0	GUARNIZIONE INGRESSO ARI	2.000	PZ	GN1584A0	RACCORDO ANGOLARE D30-D16	1.000	PZ	RC1042A0	FASCETTA BIFILARE A MOLLA D21.5-22.6 TUB	1.000	PZ	TB3068B0	TUBO D30 COLLETTORE ARIA VENTURI XEBC-10	1.000	PZ	VM1794A0	FASCETTA 430X4.8 PA66 NERA	1.000	PZ
					Code	Description	Qty	UOM																					
					GN1544A0	GUARNIZIONE INGRESSO ARI	2.000	PZ																					
					GN1584A0	RACCORDO ANGOLARE D30-D16	1.000	PZ																					
					RC1042A0	FASCETTA BIFILARE A MOLLA D21.5-22.6 TUB	1.000	PZ																					
					TB3068B0	TUBO D30 COLLETTORE ARIA VENTURI XEBC-10	1.000	PZ																					
			VM1794A0	FASCETTA 430X4.8 PA66 NERA	1.000	PZ																							
			KTB3019A	20XX/16XX UPPER VENTURI COLLECT PIPE KIT	<table border="1"> <thead> <tr> <th>Code</th> <th>Description</th> <th>Qty</th> <th>UOM</th> </tr> </thead> <tbody> <tr> <td>GN1544A0</td> <td>GUARNIZIONE INGRESSO ARI</td> <td>1.000</td> <td>PZ</td> </tr> <tr> <td>GN1584A0</td> <td>RACCORDO ANGOLARE D30-D16</td> <td>1.000</td> <td>PZ</td> </tr> <tr> <td>RC1042A0</td> <td>FASCETTA BIFILARE A MOLLA D21.5-22.6 TUB</td> <td>1.000</td> <td>PZ</td> </tr> <tr> <td>TB3019A1</td> <td>TUBO INGRESSO ARIA D30 SUP XEVC-2011</td> <td>1.000</td> <td>PZ</td> </tr> <tr> <td>VM1794A0</td> <td>FASCETTA 430X4.8 PA66 NERA</td> <td>1.000</td> <td>PZ</td> </tr> </tbody> </table>	Code	Description	Qty	UOM	GN1544A0	GUARNIZIONE INGRESSO ARI	1.000	PZ	GN1584A0	RACCORDO ANGOLARE D30-D16	1.000	PZ	RC1042A0	FASCETTA BIFILARE A MOLLA D21.5-22.6 TUB	1.000	PZ	TB3019A1	TUBO INGRESSO ARIA D30 SUP XEVC-2011	1.000	PZ	VM1794A0	FASCETTA 430X4.8 PA66 NERA	1.000	PZ
					Code	Description	Qty	UOM																					
					GN1544A0	GUARNIZIONE INGRESSO ARI	1.000	PZ																					
					GN1584A0	RACCORDO ANGOLARE D30-D16	1.000	PZ																					
					RC1042A0	FASCETTA BIFILARE A MOLLA D21.5-22.6 TUB	1.000	PZ																					
					TB3019A1	TUBO INGRESSO ARIA D30 SUP XEVC-2011	1.000	PZ																					
			VM1794A0	FASCETTA 430X4.8 PA66 NERA	1.000	PZ																							
			KTB2979C	XEBC-10XX-E VENTURI COLLECTOR PIPE KI	<table border="1"> <thead> <tr> <th>Code</th> <th>Description</th> <th>Qty</th> <th>UOM</th> </tr> </thead> <tbody> <tr> <td>GN1544A0</td> <td>GUARNIZIONE INGRESSO ARI</td> <td>2.000</td> <td>PZ</td> </tr> <tr> <td>GN1584A0</td> <td>RACCORDO ANGOLARE D30-D16</td> <td>1.000</td> <td>PZ</td> </tr> <tr> <td>RC1042A0</td> <td>FASCETTA BIFILARE A MOLLA D21.5-22.6 TUB</td> <td>1.000</td> <td>PZ</td> </tr> <tr> <td>TB2979C0</td> <td>TUBO COLLETTORE VENTURI D30 XEBC-10EU-E</td> <td>1.000</td> <td>PZ</td> </tr> <tr> <td>VM1794A0</td> <td>FASCETTA 430X4.8 PA66 NERA</td> <td>1.000</td> <td>PZ</td> </tr> </tbody> </table>	Code	Description	Qty	UOM	GN1544A0	GUARNIZIONE INGRESSO ARI	2.000	PZ	GN1584A0	RACCORDO ANGOLARE D30-D16	1.000	PZ	RC1042A0	FASCETTA BIFILARE A MOLLA D21.5-22.6 TUB	1.000	PZ	TB2979C0	TUBO COLLETTORE VENTURI D30 XEBC-10EU-E	1.000	PZ	VM1794A0	FASCETTA 430X4.8 PA66 NERA	1.000	PZ
					Code	Description	Qty	UOM																					
					GN1544A0	GUARNIZIONE INGRESSO ARI	2.000	PZ																					
					GN1584A0	RACCORDO ANGOLARE D30-D16	1.000	PZ																					
RC1042A0	FASCETTA BIFILARE A MOLLA D21.5-22.6 TUB	1.000			PZ																								
TB2979C0	TUBO COLLETTORE VENTURI D30 XEBC-10EU-E	1.000			PZ																								
VM1794A0	FASCETTA 430X4.8 PA66 NERA	1.000	PZ																										





COMPONENT			SPARE PART																										
Code	Description	Image	Code	Description	Kit components																								
RC1042A	FASCETTA BIFILARE A MOLLA D21.5-22.6 TUB		KTB2978B	06EU/FS/21 VENTURI COLLECTOR PIPE KI	<table border="1"> <thead> <tr> <th>Code</th> <th>Description</th> <th>Qty</th> <th>UOM</th> </tr> </thead> <tbody> <tr> <td>GN1544A0</td> <td>GUARNIZIONE INGRESSO ARI</td> <td>1.000</td> <td>PZ</td> </tr> <tr> <td>GN1584A0</td> <td>RACCORDO ANGOLARE D30-D16</td> <td>1.000</td> <td>PZ</td> </tr> <tr> <td>RC1042A0</td> <td>FASCETTA BIFILARE A MOLLA D21.5-22.6 TUB</td> <td>1.000</td> <td>PZ</td> </tr> <tr> <td>TB2978B0</td> <td>TUBO COLLETTORE VENTURI D30 XEBC-06EU-E</td> <td>1.000</td> <td>PZ</td> </tr> <tr> <td>VM1794A0</td> <td>FASCETTA 430X4.8 PA66 NERA</td> <td>1.000</td> <td>PZ</td> </tr> </tbody> </table>	Code	Description	Qty	UOM	GN1544A0	GUARNIZIONE INGRESSO ARI	1.000	PZ	GN1584A0	RACCORDO ANGOLARE D30-D16	1.000	PZ	RC1042A0	FASCETTA BIFILARE A MOLLA D21.5-22.6 TUB	1.000	PZ	TB2978B0	TUBO COLLETTORE VENTURI D30 XEBC-06EU-E	1.000	PZ	VM1794A0	FASCETTA 430X4.8 PA66 NERA	1.000	PZ
					Code	Description	Qty	UOM																					
					GN1544A0	GUARNIZIONE INGRESSO ARI	1.000	PZ																					
					GN1584A0	RACCORDO ANGOLARE D30-D16	1.000	PZ																					
			RC1042A0	FASCETTA BIFILARE A MOLLA D21.5-22.6 TUB	1.000	PZ																							
			TB2978B0	TUBO COLLETTORE VENTURI D30 XEBC-06EU-E	1.000	PZ																							
			VM1794A0	FASCETTA 430X4.8 PA66 NERA	1.000	PZ																							
			KTB2959B	XEVC-1011-E VENTURI COLLECTOR PIPE KI	<table border="1"> <thead> <tr> <th>Code</th> <th>Description</th> <th>Qty</th> <th>UOM</th> </tr> </thead> <tbody> <tr> <td>GN1544A0</td> <td>GUARNIZIONE INGRESSO ARI</td> <td>2.000</td> <td>PZ</td> </tr> <tr> <td>GN1584A0</td> <td>RACCORDO ANGOLARE D30-D16</td> <td>1.000</td> <td>PZ</td> </tr> <tr> <td>RC1042A0</td> <td>FASCETTA BIFILARE A MOLLA D21.5-22.6 TUB</td> <td>1.000</td> <td>PZ</td> </tr> <tr> <td>TB2959B0</td> <td>TUBO COLLETTORE VENTURI D30 XEVC-1011-E</td> <td>1.000</td> <td>PZ</td> </tr> <tr> <td>VM1794A0</td> <td>FASCETTA 430X4.8 PA66 NERA</td> <td>1.000</td> <td>PZ</td> </tr> </tbody> </table>	Code	Description	Qty	UOM	GN1544A0	GUARNIZIONE INGRESSO ARI	2.000	PZ	GN1584A0	RACCORDO ANGOLARE D30-D16	1.000	PZ	RC1042A0	FASCETTA BIFILARE A MOLLA D21.5-22.6 TUB	1.000	PZ	TB2959B0	TUBO COLLETTORE VENTURI D30 XEVC-1011-E	1.000	PZ	VM1794A0	FASCETTA 430X4.8 PA66 NERA	1.000	PZ
					Code	Description	Qty	UOM																					
					GN1544A0	GUARNIZIONE INGRESSO ARI	2.000	PZ																					
					GN1584A0	RACCORDO ANGOLARE D30-D16	1.000	PZ																					
			RC1042A0	FASCETTA BIFILARE A MOLLA D21.5-22.6 TUB	1.000	PZ																							
TB2959B0	TUBO COLLETTORE VENTURI D30 XEVC-1011-E	1.000	PZ																										
VM1794A0	FASCETTA 430X4.8 PA66 NERA	1.000	PZ																										
KTB2958B	XEVC-0711-E VENTURI COLLECTOR PIPE KI	<table border="1"> <thead> <tr> <th>Code</th> <th>Description</th> <th>Qty</th> <th>UOM</th> </tr> </thead> <tbody> <tr> <td>GN1544A0</td> <td>GUARNIZIONE INGRESSO ARI</td> <td>1.000</td> <td>PZ</td> </tr> <tr> <td>GN1584A0</td> <td>RACCORDO ANGOLARE D30-D16</td> <td>1.000</td> <td>PZ</td> </tr> <tr> <td>RC1042A0</td> <td>FASCETTA BIFILARE A MOLLA D21.5-22.6 TUB</td> <td>1.000</td> <td>PZ</td> </tr> <tr> <td>TB2958B0</td> <td>TUBO COLLETTORE VENTURI D30 XEVC-0711-E</td> <td>1.000</td> <td>PZ</td> </tr> </tbody> </table>	Code	Description	Qty	UOM	GN1544A0	GUARNIZIONE INGRESSO ARI	1.000	PZ	GN1584A0	RACCORDO ANGOLARE D30-D16	1.000	PZ	RC1042A0	FASCETTA BIFILARE A MOLLA D21.5-22.6 TUB	1.000	PZ	TB2958B0	TUBO COLLETTORE VENTURI D30 XEVC-0711-E	1.000	PZ							
		Code	Description	Qty	UOM																								
		GN1544A0	GUARNIZIONE INGRESSO ARI	1.000	PZ																								
		GN1584A0	RACCORDO ANGOLARE D30-D16	1.000	PZ																								
RC1042A0	FASCETTA BIFILARE A MOLLA D21.5-22.6 TUB	1.000	PZ																										
TB2958B0	TUBO COLLETTORE VENTURI D30 XEVC-0711-E	1.000	PZ																										

COMPONENT			SPARE PART																										
Code	Description	Image	Code	Description	Kit components																								
RC1042A	FASCETTA BIFILARE A MOLLA D21.5-22.6 TUB		KTB2957B	0511/04EU-E VENTURI COLLECTOR PIPE KI	<table border="1"> <thead> <tr> <th>Code</th> <th>Description</th> <th>Qty</th> <th>UOM</th> </tr> </thead> <tbody> <tr> <td>GN1544A0</td> <td>GUARNIZIONE INGRESSO ARI</td> <td>1.000</td> <td>PZ</td> </tr> <tr> <td>GN1584A0</td> <td>RACCORDO ANGOLARE D30-D16</td> <td>1.000</td> <td>PZ</td> </tr> <tr> <td>RC1042A0</td> <td>FASCETTA BIFILARE A MOLLA D21.5-22.6 TUB</td> <td>1.000</td> <td>PZ</td> </tr> <tr> <td>TB2957B0</td> <td>TUBO COLLETTORE VENTURI D30 XEVC-0511-E</td> <td>1.000</td> <td>PZ</td> </tr> <tr> <td>VM1794A0</td> <td>FASCETTA 430X4.8 PA66 NERA</td> <td>1.000</td> <td>PZ</td> </tr> </tbody> </table>	Code	Description	Qty	UOM	GN1544A0	GUARNIZIONE INGRESSO ARI	1.000	PZ	GN1584A0	RACCORDO ANGOLARE D30-D16	1.000	PZ	RC1042A0	FASCETTA BIFILARE A MOLLA D21.5-22.6 TUB	1.000	PZ	TB2957B0	TUBO COLLETTORE VENTURI D30 XEVC-0511-E	1.000	PZ	VM1794A0	FASCETTA 430X4.8 PA66 NERA	1.000	PZ
					Code	Description	Qty	UOM																					
					GN1544A0	GUARNIZIONE INGRESSO ARI	1.000	PZ																					
					GN1584A0	RACCORDO ANGOLARE D30-D16	1.000	PZ																					
			RC1042A0	FASCETTA BIFILARE A MOLLA D21.5-22.6 TUB	1.000	PZ																							
			TB2957B0	TUBO COLLETTORE VENTURI D30 XEVC-0511-E	1.000	PZ																							
			VM1794A0	FASCETTA 430X4.8 PA66 NERA	1.000	PZ																							
			KTB2956A	XEVC-0311-E VENTURI COLLECTOR PIPE KI	<table border="1"> <thead> <tr> <th>Code</th> <th>Description</th> <th>Qty</th> <th>UOM</th> </tr> </thead> <tbody> <tr> <td>GN1544A0</td> <td>GUARNIZIONE INGRESSO ARI</td> <td>1.000</td> <td>PZ</td> </tr> <tr> <td>RC1042A0</td> <td>FASCETTA BIFILARE A MOLLA D21.5-22.6 TUB</td> <td>1.000</td> <td>PZ</td> </tr> <tr> <td>TB2956A0</td> <td>TUBO COLLETTORE VENTURI D30 XEVC-0311-E</td> <td>1.000</td> <td>PZ</td> </tr> </tbody> </table>	Code	Description	Qty	UOM	GN1544A0	GUARNIZIONE INGRESSO ARI	1.000	PZ	RC1042A0	FASCETTA BIFILARE A MOLLA D21.5-22.6 TUB	1.000	PZ	TB2956A0	TUBO COLLETTORE VENTURI D30 XEVC-0311-E	1.000	PZ								
					Code	Description	Qty	UOM																					
					GN1544A0	GUARNIZIONE INGRESSO ARI	1.000	PZ																					
			RC1042A0	FASCETTA BIFILARE A MOLLA D21.5-22.6 TUB	1.000	PZ																							
			TB2956A0	TUBO COLLETTORE VENTURI D30 XEVC-0311-E	1.000	PZ																							
KTB2944A	20XX/16XX LOWER VENTURI COLLECT PIPE KIT	<table border="1"> <thead> <tr> <th>Code</th> <th>Description</th> <th>Qty</th> <th>UOM</th> </tr> </thead> <tbody> <tr> <td>GN1544A0</td> <td>GUARNIZIONE INGRESSO ARI</td> <td>2.000</td> <td>PZ</td> </tr> <tr> <td>GN1584A0</td> <td>RACCORDO ANGOLARE D30-D16</td> <td>1.000</td> <td>PZ</td> </tr> <tr> <td>RC1042A0</td> <td>FASCETTA BIFILARE A MOLLA D21.5-22.6 TUB</td> <td>1.000</td> <td>PZ</td> </tr> <tr> <td>TB2944A1</td> <td>TUBO COLLETTORE ARIA VENTURI D30</td> <td>1.000</td> <td>PZ</td> </tr> <tr> <td>VM1794A0</td> <td>FASCETTA 430X4.8 PA66 NERA</td> <td>1.000</td> <td>PZ</td> </tr> </tbody> </table>	Code	Description	Qty	UOM	GN1544A0	GUARNIZIONE INGRESSO ARI	2.000	PZ	GN1584A0	RACCORDO ANGOLARE D30-D16	1.000	PZ	RC1042A0	FASCETTA BIFILARE A MOLLA D21.5-22.6 TUB	1.000	PZ	TB2944A1	TUBO COLLETTORE ARIA VENTURI D30	1.000	PZ	VM1794A0	FASCETTA 430X4.8 PA66 NERA	1.000	PZ			
		Code	Description	Qty	UOM																								
		GN1544A0	GUARNIZIONE INGRESSO ARI	2.000	PZ																								
		GN1584A0	RACCORDO ANGOLARE D30-D16	1.000	PZ																								
		RC1042A0	FASCETTA BIFILARE A MOLLA D21.5-22.6 TUB	1.000	PZ																								
TB2944A1	TUBO COLLETTORE ARIA VENTURI D30	1.000	PZ																										
VM1794A0	FASCETTA 430X4.8 PA66 NERA	1.000	PZ																										
KRC1042A	10PCS CLAMP BIFIL SPRING D21.5-22.6 KIT	<table border="1"> <thead> <tr> <th>Code</th> <th>Description</th> <th>Qty</th> <th>UOM</th> </tr> </thead> <tbody> <tr> <td>RC1042A0</td> <td>FASCETTA BIFILARE A MOLLA D21.5-22.6 TUB</td> <td>10.000</td> <td>PZ</td> </tr> </tbody> </table>	Code	Description	Qty	UOM	RC1042A0	FASCETTA BIFILARE A MOLLA D21.5-22.6 TUB	10.000	PZ																			
		Code	Description	Qty	UOM																								
RC1042A0	FASCETTA BIFILARE A MOLLA D21.5-22.6 TUB	10.000	PZ																										

COMPONENT			SPARE PART																			
Code	Description	Image	Code	Description	Kit components																	
RC1378A	FASCETTA STRINGI TUBO D25-40 ZINCATA		KVM2379A	MM 200V VENTURI ACTUATOR SYSTEM KIT	<table border="1"> <thead> <tr> <th>Code</th> <th>Description</th> <th>Qty</th> <th>UOM</th> </tr> </thead> <tbody> <tr> <td>RC1378A0</td> <td>FASCETTA STRINGI TUBO D25-40 ZINCAT</td> <td>3.000</td> <td>PZ</td> </tr> <tr> <td>TB1520A0</td> <td>TUBO D.INT=30 SP=4 GOMMA EPDM NERO</td> <td>0.120</td> <td>M</td> </tr> <tr> <td>VM2379A1</td> <td>ASM VENTURI 200V 50/60 HZ JAP</td> <td>1.000</td> <td>PZ</td> </tr> </tbody> </table>	Code	Description	Qty	UOM	RC1378A0	FASCETTA STRINGI TUBO D25-40 ZINCAT	3.000	PZ	TB1520A0	TUBO D.INT=30 SP=4 GOMMA EPDM NERO	0.120	M	VM2379A1	ASM VENTURI 200V 50/60 HZ JAP	1.000	PZ	
			Code	Description	Qty	UOM																
			RC1378A0	FASCETTA STRINGI TUBO D25-40 ZINCAT	3.000	PZ																
			TB1520A0	TUBO D.INT=30 SP=4 GOMMA EPDM NERO	0.120	M																
			VM2379A1	ASM VENTURI 200V 50/60 HZ JAP	1.000	PZ																
			KVM2378A	MM 240V VENTURI ACTUATOR SYSTEM KIT	<table border="1"> <thead> <tr> <th>Code</th> <th>Description</th> <th>Qty</th> <th>UOM</th> </tr> </thead> <tbody> <tr> <td>RC1378A0</td> <td>FASCETTA STRINGI TUBO D25-40 ZINCAT</td> <td>3.000</td> <td>PZ</td> </tr> <tr> <td>TB1520A0</td> <td>TUBO D.INT=30 SP=4 GOMMA EPDM NERO</td> <td>0.050</td> <td>M</td> </tr> <tr> <td>VM2378A1</td> <td>ASM VENTURI 240V 50/60 HZ UL USA</td> <td>1.000</td> <td>PZ</td> </tr> </tbody> </table>	Code	Description	Qty	UOM	RC1378A0	FASCETTA STRINGI TUBO D25-40 ZINCAT	3.000	PZ	TB1520A0	TUBO D.INT=30 SP=4 GOMMA EPDM NERO	0.050	M	VM2378A1	ASM VENTURI 240V 50/60 HZ UL USA	1.000	PZ	
			Code	Description	Qty	UOM																
			RC1378A0	FASCETTA STRINGI TUBO D25-40 ZINCAT	3.000	PZ																
			TB1520A0	TUBO D.INT=30 SP=4 GOMMA EPDM NERO	0.050	M																
			VM2378A1	ASM VENTURI 240V 50/60 HZ UL USA	1.000	PZ																
			KVM2377A	MM 220 V VENTURI ACTUATOR SYSTEM KIT	<table border="1"> <thead> <tr> <th>Code</th> <th>Description</th> <th>Qty</th> <th>UOM</th> </tr> </thead> <tbody> <tr> <td>RC1378A0</td> <td>FASCETTA STRINGI TUBO D25-40 ZINCAT</td> <td>3.000</td> <td>PZ</td> </tr> <tr> <td>TB1520A0</td> <td>TUBO D.INT=30 SP=4 GOMMA EPDM NERO</td> <td>0.120</td> <td>M</td> </tr> <tr> <td>VM2377A1</td> <td>ASM VENTURI 220V 50/60 HZ EU</td> <td>1.000</td> <td>PZ</td> </tr> </tbody> </table>	Code	Description	Qty	UOM	RC1378A0	FASCETTA STRINGI TUBO D25-40 ZINCAT	3.000	PZ	TB1520A0	TUBO D.INT=30 SP=4 GOMMA EPDM NERO	0.120	M	VM2377A1	ASM VENTURI 220V 50/60 HZ EU	1.000	PZ	
			Code	Description	Qty	UOM																
RC1378A0	FASCETTA STRINGI TUBO D25-40 ZINCAT	3.000	PZ																			
TB1520A0	TUBO D.INT=30 SP=4 GOMMA EPDM NERO	0.120	M																			
VM2377A1	ASM VENTURI 220V 50/60 HZ EU	1.000	PZ																			
KVE1140A	S.5/5E JAPAN VERSION VENTURI COIL KIT	<table border="1"> <thead> <tr> <th>Code</th> <th>Description</th> <th>Qty</th> <th>UOM</th> </tr> </thead> <tbody> <tr> <td>RC1378A0</td> <td>FASCETTA STRINGI TUBO D25-40 ZINCAT</td> <td>2.000</td> <td>PZ</td> </tr> <tr> <td>TB1520A0</td> <td>TUBO D.INT=30 SP=4 GOMMA EPDM NERO</td> <td>0.050</td> <td>M</td> </tr> <tr> <td>VI1220A1</td> <td>VITE AUTOFIL. 4.2X11 TCS+ MARUTEX</td> <td>1.000</td> <td>PZ</td> </tr> <tr> <td>VM2632A0</td> <td>ASM BOBINA VENTURI S.5 VE1140A JAP</td> <td>1.000</td> <td>PZ</td> </tr> </tbody> </table>	Code	Description	Qty	UOM	RC1378A0	FASCETTA STRINGI TUBO D25-40 ZINCAT	2.000	PZ	TB1520A0	TUBO D.INT=30 SP=4 GOMMA EPDM NERO	0.050	M	VI1220A1	VITE AUTOFIL. 4.2X11 TCS+ MARUTEX	1.000	PZ	VM2632A0	ASM BOBINA VENTURI S.5 VE1140A JAP	1.000	PZ
Code	Description	Qty	UOM																			
RC1378A0	FASCETTA STRINGI TUBO D25-40 ZINCAT	2.000	PZ																			
TB1520A0	TUBO D.INT=30 SP=4 GOMMA EPDM NERO	0.050	M																			
VI1220A1	VITE AUTOFIL. 4.2X11 TCS+ MARUTEX	1.000	PZ																			
VM2632A0	ASM BOBINA VENTURI S.5 VE1140A JAP	1.000	PZ																			

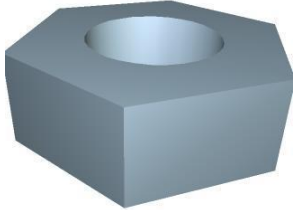
COMPONENT			SPARE PART																		
Code	Description	Image	Code	Description	Kit components																
RC1378A	FASCETTA STRINGI TUBO D25-40 ZINCATA		KVE1014A	US VERSION SERIES 5 VENTURI COIL KIT	<table border="1"> <thead> <tr> <th>Code</th> <th>Description</th> <th>Qty</th> <th>UOM</th> </tr> </thead> <tbody> <tr> <td>RC1378A0</td> <td>FASCETTA STRINGI TUBO D25-40 ZINCAT</td> <td>2.000</td> <td>PZ</td> </tr> <tr> <td>TB1520A0</td> <td>TUBO D.INT=30 SP=4 GOMMA EPDM NERO</td> <td>0.050</td> <td>M</td> </tr> <tr> <td>VM2633A0</td> <td>ASM BOBINA VENTURI 120V S.5 VE1014A0 USA</td> <td>1.000</td> <td>PZ</td> </tr> </tbody> </table>	Code	Description	Qty	UOM	RC1378A0	FASCETTA STRINGI TUBO D25-40 ZINCAT	2.000	PZ	TB1520A0	TUBO D.INT=30 SP=4 GOMMA EPDM NERO	0.050	M	VM2633A0	ASM BOBINA VENTURI 120V S.5 VE1014A0 USA	1.000	PZ
			Code	Description	Qty	UOM															
RC1378A0	FASCETTA STRINGI TUBO D25-40 ZINCAT	2.000	PZ																		
TB1520A0	TUBO D.INT=30 SP=4 GOMMA EPDM NERO	0.050	M																		
VM2633A0	ASM BOBINA VENTURI 120V S.5 VE1014A0 USA	1.000	PZ																		
KRC1378A	HOSE CLAMP 10 PCS KIT	<table border="1"> <thead> <tr> <th>Code</th> <th>Description</th> <th>Qty</th> <th>UOM</th> </tr> </thead> <tbody> <tr> <td>RC1378A0</td> <td>FASCETTA STRINGI TUBO D25-40 ZINCAT</td> <td>10.000</td> <td>PZ</td> </tr> </tbody> </table>	Code	Description	Qty	UOM	RC1378A0	FASCETTA STRINGI TUBO D25-40 ZINCAT	10.000	PZ											
Code	Description	Qty	UOM																		
RC1378A0	FASCETTA STRINGI TUBO D25-40 ZINCAT	10.000	PZ																		
TB1956A	TB1520A-GREY SILICONE PIPE L=0,04M		KTB1002A	BLACK TUBE KIT EPDM 240MT TB1520A	<table border="1"> <thead> <tr> <th>Code</th> <th>Description</th> <th>Qty</th> <th>UOM</th> </tr> </thead> <tbody> <tr> <td>TB1520A0</td> <td>TUBO D.INT=30 SP=4 GOMMA EPDM NERO</td> <td>240.000</td> <td>M</td> </tr> </tbody> </table>	Code	Description	Qty	UOM	TB1520A0	TUBO D.INT=30 SP=4 GOMMA EPDM NERO	240.000	M								
			Code	Description	Qty	UOM															
			TB1520A0	TUBO D.INT=30 SP=4 GOMMA EPDM NERO	240.000	M															
KTB1001A	BLACK TUBE KIT EPDM 10MT TB1520	<table border="1"> <thead> <tr> <th>Code</th> <th>Description</th> <th>Qty</th> <th>UOM</th> </tr> </thead> <tbody> <tr> <td>TB1520A0</td> <td>TUBO D.INT=30 SP=4 GOMMA EPDM NERO</td> <td>10.000</td> <td>M</td> </tr> <tr> <td>VM1794A0</td> <td>FASCETTA 430X4.8 PA66 NERA</td> <td>3.000</td> <td>PZ</td> </tr> </tbody> </table>	Code	Description	Qty	UOM	TB1520A0	TUBO D.INT=30 SP=4 GOMMA EPDM NERO	10.000	M	VM1794A0	FASCETTA 430X4.8 PA66 NERA	3.000	PZ							
Code	Description	Qty	UOM																		
TB1520A0	TUBO D.INT=30 SP=4 GOMMA EPDM NERO	10.000	M																		
VM1794A0	FASCETTA 430X4.8 PA66 NERA	3.000	PZ																		
KTB1000A	EPDM BLACK TUBE TB1520A 2MT KIT	<table border="1"> <thead> <tr> <th>Code</th> <th>Description</th> <th>Qty</th> <th>UOM</th> </tr> </thead> <tbody> <tr> <td>RC1055A0</td> <td>FASCETTA STRINGI TUBO Ø25-40 H12 INOX</td> <td>2.000</td> <td>PZ</td> </tr> <tr> <td>TB1520A0</td> <td>TUBO D.INT=30 SP=4 GOMMA EPDM NERO</td> <td>2.000</td> <td>M</td> </tr> </tbody> </table>	Code	Description	Qty	UOM	RC1055A0	FASCETTA STRINGI TUBO Ø25-40 H12 INOX	2.000	PZ	TB1520A0	TUBO D.INT=30 SP=4 GOMMA EPDM NERO	2.000	M							
Code	Description	Qty	UOM																		
RC1055A0	FASCETTA STRINGI TUBO Ø25-40 H12 INOX	2.000	PZ																		
TB1520A0	TUBO D.INT=30 SP=4 GOMMA EPDM NERO	2.000	M																		
TB2603A	TB1520A0- VENTURI FAN 0,12M		KTB2603A	COUNTERTOP OVENS VENTURI CONN. PIPE KIT	<table border="1"> <thead> <tr> <th>Code</th> <th>Description</th> <th>Qty</th> <th>UOM</th> </tr> </thead> <tbody> <tr> <td>TB1520A0</td> <td>TUBO D.INT=30 SP=4 GOMMA EPDM NERO</td> <td>0.120</td> <td>M</td> </tr> </tbody> </table>	Code	Description	Qty	UOM	TB1520A0	TUBO D.INT=30 SP=4 GOMMA EPDM NERO	0.120	M								
Code	Description	Qty	UOM																		
TB1520A0	TUBO D.INT=30 SP=4 GOMMA EPDM NERO	0.120	M																		

COMPONENT			SPARE PART																										
Code	Description	Image	Code	Description	Kit components																								
TB2957B	TUBO COLLETTORE VENTURI D30 XEVC-0511-E		KTB2957B	0511/04EU-E VENTURI COLLECTOR PIPE KI	<table border="1"> <thead> <tr> <th>Code</th> <th>Description</th> <th>Qty</th> <th>UOM</th> </tr> </thead> <tbody> <tr> <td>GN1544A0</td> <td>GUARNIZIONE INGRESSO ARI</td> <td>1.000</td> <td>PZ</td> </tr> <tr> <td>GN1584A0</td> <td>RACCORDO ANGOLARE D30-D16</td> <td>1.000</td> <td>PZ</td> </tr> <tr> <td>RC1042A0</td> <td>FASCETTA BIFILARE A MOLLA D21.5-22.6 TUB</td> <td>1.000</td> <td>PZ</td> </tr> <tr> <td>TB2957B0</td> <td>TUBO COLLETTORE VENTURI D30 XEVC-0511-E</td> <td>1.000</td> <td>PZ</td> </tr> <tr> <td>VM1794A0</td> <td>FASCETTA 430X4.8 PA66 NERA</td> <td>1.000</td> <td>PZ</td> </tr> </tbody> </table>	Code	Description	Qty	UOM	GN1544A0	GUARNIZIONE INGRESSO ARI	1.000	PZ	GN1584A0	RACCORDO ANGOLARE D30-D16	1.000	PZ	RC1042A0	FASCETTA BIFILARE A MOLLA D21.5-22.6 TUB	1.000	PZ	TB2957B0	TUBO COLLETTORE VENTURI D30 XEVC-0511-E	1.000	PZ	VM1794A0	FASCETTA 430X4.8 PA66 NERA	1.000	PZ
					Code	Description	Qty	UOM																					
					GN1544A0	GUARNIZIONE INGRESSO ARI	1.000	PZ																					
					GN1584A0	RACCORDO ANGOLARE D30-D16	1.000	PZ																					
					RC1042A0	FASCETTA BIFILARE A MOLLA D21.5-22.6 TUB	1.000	PZ																					
					TB2957B0	TUBO COLLETTORE VENTURI D30 XEVC-0511-E	1.000	PZ																					
VM1794A0	FASCETTA 430X4.8 PA66 NERA	1.000	PZ																										
VM2377A	ASM VENTURI 220V 50/60 HZ EU		KVM2377A	MM 220 V VENTURI ACTUATOR SYSTEM KIT	<table border="1"> <thead> <tr> <th>Code</th> <th>Description</th> <th>Qty</th> <th>UOM</th> </tr> </thead> <tbody> <tr> <td>RC1378A0</td> <td>FASCETTA STRINGI TUBO D25-40 ZINCAT</td> <td>3.000</td> <td>PZ</td> </tr> <tr> <td>TB1520A0</td> <td>TUBO D.INT=30 SP=4 GOMMA EPDM NERO</td> <td>0.120</td> <td>M</td> </tr> <tr> <td>VM2377A1</td> <td>ASM VENTURI 220V 50/60 HZ EU</td> <td>1.000</td> <td>PZ</td> </tr> </tbody> </table>	Code	Description	Qty	UOM	RC1378A0	FASCETTA STRINGI TUBO D25-40 ZINCAT	3.000	PZ	TB1520A0	TUBO D.INT=30 SP=4 GOMMA EPDM NERO	0.120	M	VM2377A1	ASM VENTURI 220V 50/60 HZ EU	1.000	PZ								
					Code	Description	Qty	UOM																					
					RC1378A0	FASCETTA STRINGI TUBO D25-40 ZINCAT	3.000	PZ																					
TB1520A0	TUBO D.INT=30 SP=4 GOMMA EPDM NERO	0.120	M																										
VM2377A1	ASM VENTURI 220V 50/60 HZ EU	1.000	PZ																										
VL1127A	RACCORDO A T BARBED 6		KVL1127A	6mm BARBED T-SHAPED FITTING 10 PCS KIT	<table border="1"> <thead> <tr> <th>Code</th> <th>Description</th> <th>Qty</th> <th>UOM</th> </tr> </thead> <tbody> <tr> <td>VL1127A1</td> <td>RACCORDO A T BARBED 6</td> <td>10.000</td> <td>PZ</td> </tr> </tbody> </table>	Code	Description	Qty	UOM	VL1127A1	RACCORDO A T BARBED 6	10.000	PZ																
					Code	Description	Qty	UOM																					
VL1127A1	RACCORDO A T BARBED 6	10.000	PZ																										
TB3253A	TB3131A-T SHAPED EXT HUM PIPE CONNECTION		KTB3131A	WHITE-BLACK 6X12 STEAM PIPE 3M KIT	<table border="1"> <thead> <tr> <th>Code</th> <th>Description</th> <th>Qty</th> <th>UOM</th> </tr> </thead> <tbody> <tr> <td>TB3131A0</td> <td>TUBO TELATO EPDM BIANCO-NERO 6X12</td> <td>3.000</td> <td>M</td> </tr> <tr> <td>VM1794A0</td> <td>FASCETTA 430X4.8 PA66 NERA</td> <td>1.000</td> <td>PZ</td> </tr> </tbody> </table>	Code	Description	Qty	UOM	TB3131A0	TUBO TELATO EPDM BIANCO-NERO 6X12	3.000	M	VM1794A0	FASCETTA 430X4.8 PA66 NERA	1.000	PZ												
					Code	Description	Qty	UOM																					
TB3131A0	TUBO TELATO EPDM BIANCO-NERO 6X12	3.000	M																										
VM1794A0	FASCETTA 430X4.8 PA66 NERA	1.000	PZ																										

COMPONENT			SPARE PART																										
Code	Description	Image	Code	Description	Kit components																								
RC1170A	DADO M14 H7 CH22 INOX DIN 439		KRC1170A	M14 H8 CH22 NUT - 10 PCS. KIT	<table border="1"> <thead> <tr> <th>Code</th> <th>Description</th> <th>Qty</th> <th>UOM</th> </tr> </thead> <tbody> <tr> <td>RC1170A1</td> <td>DADO M14 H7 CH22 INOX DIN 439</td> <td>10.000</td> <td>PZ</td> </tr> </tbody> </table>	Code	Description	Qty	UOM	RC1170A1	DADO M14 H7 CH22 INOX DIN 439	10.000	PZ																
Code	Description	Qty	UOM																										
RC1170A1	DADO M14 H7 CH22 INOX DIN 439	10.000	PZ																										
TB3429A	TUBO EST UMID D10 CON RACCORDO XEVL EL		KTB3429A	D10 HUMIDITY EXT TUBE WITH XEVL EL CONNE	<table border="1"> <thead> <tr> <th>Code</th> <th>Description</th> <th>Qty</th> <th>UOM</th> </tr> </thead> <tbody> <tr> <td>RC1018A0</td> <td>FASCETTA ELASTICA D12 ZINCATA</td> <td>1.000</td> <td>PZ</td> </tr> <tr> <td>TB3429A0</td> <td>TUBO EST UMID D10 CON RACCORDO XEVL EL</td> <td>1.000</td> <td>PZ</td> </tr> <tr> <td>VI1121A0</td> <td>DADO M14X2 H6.4 CH22 A4</td> <td>1.000</td> <td>PZ</td> </tr> </tbody> </table>	Code	Description	Qty	UOM	RC1018A0	FASCETTA ELASTICA D12 ZINCATA	1.000	PZ	TB3429A0	TUBO EST UMID D10 CON RACCORDO XEVL EL	1.000	PZ	VI1121A0	DADO M14X2 H6.4 CH22 A4	1.000	PZ								
Code	Description	Qty	UOM																										
RC1018A0	FASCETTA ELASTICA D12 ZINCATA	1.000	PZ																										
TB3429A0	TUBO EST UMID D10 CON RACCORDO XEVL EL	1.000	PZ																										
VI1121A0	DADO M14X2 H6.4 CH22 A4	1.000	PZ																										
0H8035A	MM CORE PROBE ACCESS COVER		0H8035A0	MM CORE PROBE ACCESS COVER																									
GN1632A	GUARNIZIONE TENUTA INGRESSO SONDA-CUORE		KSN1050B	BIG-L L3200 SINGLE POINT CORE PROBE KIT	<table border="1"> <thead> <tr> <th>Code</th> <th>Description</th> <th>Qty</th> <th>UOM</th> </tr> </thead> <tbody> <tr> <td>0H8120A0</td> <td>COPERCHIO INGRESSO BULBO XEVL</td> <td>1.000</td> <td>PZ</td> </tr> <tr> <td>GN1632A0</td> <td>GUARNIZIONE TENUTA INGRESSO SONDA-CUOR</td> <td>1.000</td> <td>PZ</td> </tr> <tr> <td>SL1045A0</td> <td>SILICONE ANTRACITE S57 80 ml</td> <td>1.000</td> <td>PZ</td> </tr> <tr> <td>SN1050B0</td> <td>SONDA CUORE MONOPUNTO L3200 PEEK DRITTA</td> <td>1.000</td> <td>PZ</td> </tr> <tr> <td>VI1220A1</td> <td>VITE AUTOFIL. 4.2X11 TCS+ MARUTEX</td> <td>3.000</td> <td>PZ</td> </tr> </tbody> </table>	Code	Description	Qty	UOM	0H8120A0	COPERCHIO INGRESSO BULBO XEVL	1.000	PZ	GN1632A0	GUARNIZIONE TENUTA INGRESSO SONDA-CUOR	1.000	PZ	SL1045A0	SILICONE ANTRACITE S57 80 ml	1.000	PZ	SN1050B0	SONDA CUORE MONOPUNTO L3200 PEEK DRITTA	1.000	PZ	VI1220A1	VITE AUTOFIL. 4.2X11 TCS+ MARUTEX	3.000	PZ
Code	Description	Qty	UOM																										
0H8120A0	COPERCHIO INGRESSO BULBO XEVL	1.000	PZ																										
GN1632A0	GUARNIZIONE TENUTA INGRESSO SONDA-CUOR	1.000	PZ																										
SL1045A0	SILICONE ANTRACITE S57 80 ml	1.000	PZ																										
SN1050B0	SONDA CUORE MONOPUNTO L3200 PEEK DRITTA	1.000	PZ																										
VI1220A1	VITE AUTOFIL. 4.2X11 TCS+ MARUTEX	3.000	PZ																										





COMPONENT			SPARE PART																										
Code	Description	Image	Code	Description	Kit components																								
GN1632A	GUARNIZIONE TENUTA INGRESSO SONDA-CUORE		KSN1050A	SINGLE POINT CORE PROBE KIT L3200 BIG-L	<table border="1"> <thead> <tr> <th>Code</th> <th>Description</th> <th>Qty</th> <th>UOM</th> </tr> </thead> <tbody> <tr> <td>0H7030A0</td> <td>COPERCHIO INGRESSO BULBO</td> <td>1.000</td> <td>PZ</td> </tr> <tr> <td>GN1632A0</td> <td>GUARNIZIONE TENUTA INGRESSO SONDA-CUOR</td> <td>1.000</td> <td>PZ</td> </tr> <tr> <td>SL1045A0</td> <td>SILICONE ANTRACITE S57 80 ml</td> <td>1.000</td> <td>PZ</td> </tr> <tr> <td>SN1050A1</td> <td>SONDA CUORE MONOPUNTO L3200 PEEK DRITTA</td> <td>1.000</td> <td>PZ</td> </tr> <tr> <td>VI1220A1</td> <td>VITE AUTOFIL. 4.2X11 TCS+ MARUTEX</td> <td>3.000</td> <td>PZ</td> </tr> </tbody> </table>	Code	Description	Qty	UOM	0H7030A0	COPERCHIO INGRESSO BULBO	1.000	PZ	GN1632A0	GUARNIZIONE TENUTA INGRESSO SONDA-CUOR	1.000	PZ	SL1045A0	SILICONE ANTRACITE S57 80 ml	1.000	PZ	SN1050A1	SONDA CUORE MONOPUNTO L3200 PEEK DRITTA	1.000	PZ	VI1220A1	VITE AUTOFIL. 4.2X11 TCS+ MARUTEX	3.000	PZ
			Code	Description	Qty	UOM																							
			0H7030A0	COPERCHIO INGRESSO BULBO	1.000	PZ																							
GN1632A0	GUARNIZIONE TENUTA INGRESSO SONDA-CUOR	1.000	PZ																										
SL1045A0	SILICONE ANTRACITE S57 80 ml	1.000	PZ																										
SN1050A1	SONDA CUORE MONOPUNTO L3200 PEEK DRITTA	1.000	PZ																										
VI1220A1	VITE AUTOFIL. 4.2X11 TCS+ MARUTEX	3.000	PZ																										
KSN1049B	MULTIPOINT CORE PROBE KIT L3200	<table border="1"> <thead> <tr> <th>Code</th> <th>Description</th> <th>Qty</th> <th>UOM</th> </tr> </thead> <tbody> <tr> <td>0H8119A0</td> <td>COPERCHIO INGRESSO SONDA CUORE XEVL 316</td> <td>1.000</td> <td>PZ</td> </tr> <tr> <td>GN1632A0</td> <td>GUARNIZIONE TENUTA INGRESSO SONDA-CUOR</td> <td>1.000</td> <td>PZ</td> </tr> <tr> <td>SL1045A0</td> <td>SILICONE ANTRACITE S57 80 ml</td> <td>1.000</td> <td>PZ</td> </tr> <tr> <td>SN1049B0</td> <td>SONDA CUORE MULTIPUNTO L3200 PEEK DRITTA</td> <td>1.000</td> <td>PZ</td> </tr> <tr> <td>VI1220A1</td> <td>VITE AUTOFIL. 4.2X11 TCS+ MARUTEX</td> <td>3.000</td> <td>PZ</td> </tr> </tbody> </table>	Code	Description	Qty	UOM	0H8119A0	COPERCHIO INGRESSO SONDA CUORE XEVL 316	1.000	PZ	GN1632A0	GUARNIZIONE TENUTA INGRESSO SONDA-CUOR	1.000	PZ	SL1045A0	SILICONE ANTRACITE S57 80 ml	1.000	PZ	SN1049B0	SONDA CUORE MULTIPUNTO L3200 PEEK DRITTA	1.000	PZ	VI1220A1	VITE AUTOFIL. 4.2X11 TCS+ MARUTEX	3.000	PZ			
Code	Description	Qty	UOM																										
0H8119A0	COPERCHIO INGRESSO SONDA CUORE XEVL 316	1.000	PZ																										
GN1632A0	GUARNIZIONE TENUTA INGRESSO SONDA-CUOR	1.000	PZ																										
SL1045A0	SILICONE ANTRACITE S57 80 ml	1.000	PZ																										
SN1049B0	SONDA CUORE MULTIPUNTO L3200 PEEK DRITTA	1.000	PZ																										
VI1220A1	VITE AUTOFIL. 4.2X11 TCS+ MARUTEX	3.000	PZ																										
KSN1032A	SINGLE POINT CORE PROBE KIT L2750	<table border="1"> <thead> <tr> <th>Code</th> <th>Description</th> <th>Qty</th> <th>UOM</th> </tr> </thead> <tbody> <tr> <td>0H8120A0</td> <td>COPERCHIO INGRESSO BULBO XEVL</td> <td>1.000</td> <td>PZ</td> </tr> <tr> <td>GN1632A0</td> <td>GUARNIZIONE TENUTA INGRESSO SONDA-CUOR</td> <td>1.000</td> <td>PZ</td> </tr> <tr> <td>SL1045A0</td> <td>SILICONE ANTRACITE S57 80 ml</td> <td>1.000</td> <td>PZ</td> </tr> </tbody> </table>	Code	Description	Qty	UOM	0H8120A0	COPERCHIO INGRESSO BULBO XEVL	1.000	PZ	GN1632A0	GUARNIZIONE TENUTA INGRESSO SONDA-CUOR	1.000	PZ	SL1045A0	SILICONE ANTRACITE S57 80 ml	1.000	PZ											
Code	Description	Qty	UOM																										
0H8120A0	COPERCHIO INGRESSO BULBO XEVL	1.000	PZ																										
GN1632A0	GUARNIZIONE TENUTA INGRESSO SONDA-CUOR	1.000	PZ																										
SL1045A0	SILICONE ANTRACITE S57 80 ml	1.000	PZ																										

COMPONENT			SPARE PART																								
Code	Description	Image	Code	Description	Kit components																						
GN1632A	GUARNIZIONE TENUTA INGRESSO SONDA-CUORE		KSN1032A	SINGLE POINT CORE PROBE KIT L2750	<table border="1"> <thead> <tr> <th>Code</th> <th>Description</th> <th>Qty</th> <th>UOM</th> </tr> </thead> <tbody> <tr> <td>SN1032A0</td> <td>SONDA CUORE MONOPUNTO L2750 NO RACCORDO</td> <td>1.000</td> <td>PZ</td> </tr> <tr> <td>VI1220A1</td> <td>VITE AUTOFIL. 4.2X11 TCS+ MARUTEX</td> <td>3.000</td> <td>PZ</td> </tr> </tbody> </table>		Code	Description	Qty	UOM	SN1032A0	SONDA CUORE MONOPUNTO L2750 NO RACCORDO	1.000	PZ	VI1220A1	VITE AUTOFIL. 4.2X11 TCS+ MARUTEX	3.000	PZ									
			Code	Description	Qty	UOM																					
			SN1032A0	SONDA CUORE MONOPUNTO L2750 NO RACCORDO	1.000	PZ																					
VI1220A1	VITE AUTOFIL. 4.2X11 TCS+ MARUTEX	3.000	PZ																								
KSN1031A	SINGLE POINT CORE PROBE KIT L2000	<table border="1"> <thead> <tr> <th>Code</th> <th>Description</th> <th>Qty</th> <th>UOM</th> </tr> </thead> <tbody> <tr> <td>0H8120A0</td> <td>COPERCHIO INGRESSO BULBO XEVL</td> <td>1.000</td> <td>PZ</td> </tr> <tr> <td>GN1632A0</td> <td>GUARNIZIONE TENUTA INGRESSO SONDA-CUOR</td> <td>1.000</td> <td>PZ</td> </tr> <tr> <td>SL1045A0</td> <td>SILICONE ANTRACITE S57 80 ml</td> <td>1.000</td> <td>PZ</td> </tr> <tr> <td>SN1031A2</td> <td>SONDA CUORE MONOP DRITTA L2000 NO RACC</td> <td>1.000</td> <td>PZ</td> </tr> <tr> <td>VI1220A1</td> <td>VITE AUTOFIL. 4.2X11 TCS+ MARUTEX</td> <td>3.000</td> <td>PZ</td> </tr> </tbody> </table>		Code	Description	Qty	UOM	0H8120A0	COPERCHIO INGRESSO BULBO XEVL	1.000	PZ	GN1632A0	GUARNIZIONE TENUTA INGRESSO SONDA-CUOR	1.000	PZ	SL1045A0	SILICONE ANTRACITE S57 80 ml	1.000	PZ	SN1031A2	SONDA CUORE MONOP DRITTA L2000 NO RACC	1.000	PZ	VI1220A1	VITE AUTOFIL. 4.2X11 TCS+ MARUTEX	3.000	PZ
Code	Description	Qty	UOM																								
0H8120A0	COPERCHIO INGRESSO BULBO XEVL	1.000	PZ																								
GN1632A0	GUARNIZIONE TENUTA INGRESSO SONDA-CUOR	1.000	PZ																								
SL1045A0	SILICONE ANTRACITE S57 80 ml	1.000	PZ																								
SN1031A2	SONDA CUORE MONOP DRITTA L2000 NO RACC	1.000	PZ																								
VI1220A1	VITE AUTOFIL. 4.2X11 TCS+ MARUTEX	3.000	PZ																								
KSN1030A	SINGLE POINT CORE PROBE KIT L1550	<table border="1"> <thead> <tr> <th>Code</th> <th>Description</th> <th>Qty</th> <th>UOM</th> </tr> </thead> <tbody> <tr> <td>0H8120A0</td> <td>COPERCHIO INGRESSO BULBO XEVL</td> <td>1.000</td> <td>PZ</td> </tr> <tr> <td>GN1632A0</td> <td>GUARNIZIONE TENUTA INGRESSO SONDA-CUOR</td> <td>1.000</td> <td>PZ</td> </tr> <tr> <td>SL1045A0</td> <td>SILICONE ANTRACITE S57 80 ml</td> <td>1.000</td> <td>PZ</td> </tr> <tr> <td>SN1030A1</td> <td>SONDA CUORE MONOPUNTO L1550 NO RACCORDO</td> <td>1.000</td> <td>PZ</td> </tr> <tr> <td>VI1220A1</td> <td>VITE AUTOFIL. 4.2X11 TCS+ MARUTEX</td> <td>3.000</td> <td>PZ</td> </tr> </tbody> </table>		Code	Description	Qty	UOM	0H8120A0	COPERCHIO INGRESSO BULBO XEVL	1.000	PZ	GN1632A0	GUARNIZIONE TENUTA INGRESSO SONDA-CUOR	1.000	PZ	SL1045A0	SILICONE ANTRACITE S57 80 ml	1.000	PZ	SN1030A1	SONDA CUORE MONOPUNTO L1550 NO RACCORDO	1.000	PZ	VI1220A1	VITE AUTOFIL. 4.2X11 TCS+ MARUTEX	3.000	PZ
Code	Description	Qty	UOM																								
0H8120A0	COPERCHIO INGRESSO BULBO XEVL	1.000	PZ																								
GN1632A0	GUARNIZIONE TENUTA INGRESSO SONDA-CUOR	1.000	PZ																								
SL1045A0	SILICONE ANTRACITE S57 80 ml	1.000	PZ																								
SN1030A1	SONDA CUORE MONOPUNTO L1550 NO RACCORDO	1.000	PZ																								
VI1220A1	VITE AUTOFIL. 4.2X11 TCS+ MARUTEX	3.000	PZ																								

COMPONENT			SPARE PART																																																																			
Code	Description	Image	Code	Description	Kit components																																																																	
GN1632A	GUARNIZIONE TENUTA INGRESSO SONDA-CUORE		KSN1021B	US MULTI.POINT L2750 CORE PROBE KIT	<table border="1"> <thead> <tr> <th>Code</th> <th>Description</th> <th>Qty</th> <th>UOM</th> </tr> </thead> <tbody> <tr> <td>0H8119A0</td> <td>COPERCHIO INGRESSO SONDA CUORE XEVL 316</td> <td>1.000</td> <td>PZ</td> </tr> <tr> <td>CE1037A0</td> <td>GUAINA UL IN FIBRA DI VETRO SILICONICA</td> <td>1.500</td> <td>M</td> </tr> <tr> <td>CE1685A0</td> <td>MORSETTO FEMMINA ESTR. MRT8 P3,81 5P</td> <td>1.000</td> <td>PZ</td> </tr> <tr> <td>GN1632A0</td> <td>GUARNIZIONE TENUTA INGRESSO SONDA-CUOR</td> <td>1.000</td> <td>PZ</td> </tr> <tr> <td>RC1130A0</td> <td>FASCETTA 130X2,6</td> <td>2.000</td> <td>PZ</td> </tr> <tr> <td>SL1045A0</td> <td>SILICONE ANTRACITE S57 80 ml</td> <td>1.000</td> <td>PZ</td> </tr> <tr> <td>SN1012B1</td> <td>SONDA CUORE MULTIPUNTO L2750 NO RACCORDO</td> <td>1.000</td> <td>PZ</td> </tr> <tr> <td>VI1220A1</td> <td>VITE AUTOFIL. 4.2X11 TCS+ MARUTEX</td> <td>3.000</td> <td>PZ</td> </tr> </tbody> </table>	Code	Description	Qty	UOM	0H8119A0	COPERCHIO INGRESSO SONDA CUORE XEVL 316	1.000	PZ	CE1037A0	GUAINA UL IN FIBRA DI VETRO SILICONICA	1.500	M	CE1685A0	MORSETTO FEMMINA ESTR. MRT8 P3,81 5P	1.000	PZ	GN1632A0	GUARNIZIONE TENUTA INGRESSO SONDA-CUOR	1.000	PZ	RC1130A0	FASCETTA 130X2,6	2.000	PZ	SL1045A0	SILICONE ANTRACITE S57 80 ml	1.000	PZ	SN1012B1	SONDA CUORE MULTIPUNTO L2750 NO RACCORDO	1.000	PZ	VI1220A1	VITE AUTOFIL. 4.2X11 TCS+ MARUTEX	3.000	PZ	<table border="1"> <thead> <tr> <th>Code</th> <th>Description</th> <th>Qty</th> <th>UOM</th> </tr> </thead> <tbody> <tr> <td>0H8119A0</td> <td>COPERCHIO INGRESSO SONDA CUORE XEVL 316</td> <td>1.000</td> <td>PZ</td> </tr> <tr> <td>CE1037A0</td> <td>GUAINA UL IN FIBRA DI VETRO SILICONICA</td> <td>0.700</td> <td>M</td> </tr> <tr> <td>CE1685A0</td> <td>MORSETTO FEMMINA ESTR. MRT8 P3,81 5P</td> <td>1.000</td> <td>PZ</td> </tr> <tr> <td>GN1632A0</td> <td>GUARNIZIONE TENUTA INGRESSO SONDA-CUOR</td> <td>1.000</td> <td>PZ</td> </tr> <tr> <td>RC1130A0</td> <td>FASCETTA 130X2,6</td> <td>2.000</td> <td>PZ</td> </tr> <tr> <td>SL1045A0</td> <td>SILICONE ANTRACITE S57 80 ml</td> <td>1.000</td> <td>PZ</td> </tr> </tbody> </table>	Code	Description	Qty	UOM	0H8119A0	COPERCHIO INGRESSO SONDA CUORE XEVL 316	1.000	PZ	CE1037A0	GUAINA UL IN FIBRA DI VETRO SILICONICA	0.700	M	CE1685A0	MORSETTO FEMMINA ESTR. MRT8 P3,81 5P	1.000	PZ	GN1632A0	GUARNIZIONE TENUTA INGRESSO SONDA-CUOR	1.000	PZ	RC1130A0	FASCETTA 130X2,6	2.000	PZ	SL1045A0	SILICONE ANTRACITE S57 80 ml	1.000	PZ
			Code	Description	Qty	UOM																																																																
0H8119A0	COPERCHIO INGRESSO SONDA CUORE XEVL 316	1.000	PZ																																																																			
CE1037A0	GUAINA UL IN FIBRA DI VETRO SILICONICA	1.500	M																																																																			
CE1685A0	MORSETTO FEMMINA ESTR. MRT8 P3,81 5P	1.000	PZ																																																																			
GN1632A0	GUARNIZIONE TENUTA INGRESSO SONDA-CUOR	1.000	PZ																																																																			
RC1130A0	FASCETTA 130X2,6	2.000	PZ																																																																			
SL1045A0	SILICONE ANTRACITE S57 80 ml	1.000	PZ																																																																			
SN1012B1	SONDA CUORE MULTIPUNTO L2750 NO RACCORDO	1.000	PZ																																																																			
VI1220A1	VITE AUTOFIL. 4.2X11 TCS+ MARUTEX	3.000	PZ																																																																			
Code	Description	Qty	UOM																																																																			
0H8119A0	COPERCHIO INGRESSO SONDA CUORE XEVL 316	1.000	PZ																																																																			
CE1037A0	GUAINA UL IN FIBRA DI VETRO SILICONICA	0.700	M																																																																			
CE1685A0	MORSETTO FEMMINA ESTR. MRT8 P3,81 5P	1.000	PZ																																																																			
GN1632A0	GUARNIZIONE TENUTA INGRESSO SONDA-CUOR	1.000	PZ																																																																			
RC1130A0	FASCETTA 130X2,6	2.000	PZ																																																																			
SL1045A0	SILICONE ANTRACITE S57 80 ml	1.000	PZ																																																																			
			KSN1020B	US MULTIPPOINT L2050 CORE PROBE KIT																																																																		

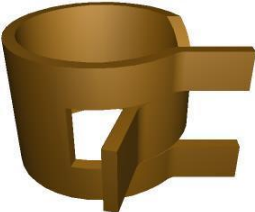
COMPONENT			SPARE PART																																																																				
Code	Description	Image	Code	Description	Kit components																																																																		
GN1632A	GUARNIZIONE TENUTA INGRESSO SONDA-CUORE		KSN1020B	US MULTIPOINT L2050 CORE PROBE KIT	<table border="1"> <thead> <tr> <th>Code</th> <th>Description</th> <th>Qty</th> <th>UOM</th> </tr> </thead> <tbody> <tr> <td>SN1002B2</td> <td>SONDA CUORE MULTIP DRITTA L2050 NO RACC</td> <td>1.000</td> <td>PZ</td> </tr> <tr> <td>VI1220A1</td> <td>VITE AUTOFIL. 4.2X11 TCS+ MARUTEX</td> <td>3.000</td> <td>PZ</td> </tr> </tbody> </table>	Code	Description	Qty	UOM	SN1002B2	SONDA CUORE MULTIP DRITTA L2050 NO RACC	1.000	PZ	VI1220A1	VITE AUTOFIL. 4.2X11 TCS+ MARUTEX	3.000	PZ	<table border="1"> <thead> <tr> <th>Code</th> <th>Description</th> <th>Qty</th> <th>UOM</th> </tr> </thead> <tbody> <tr> <td>0H8119A0</td> <td>COPERCHIO INGRESSO SONDA CUORE XEVL 316</td> <td>1.000</td> <td>PZ</td> </tr> <tr> <td>CE1037A0</td> <td>GUAINA UL IN FIBRA DI VETRO SILICONICA</td> <td>0.600</td> <td>M</td> </tr> <tr> <td>CE1685A0</td> <td>MORSETTO FEMMINA ESTR. MRT8 P3,81 5P</td> <td>1.000</td> <td>PZ</td> </tr> <tr> <td>GN1632A0</td> <td>GUARNIZIONE TENUTA INGRESSO SONDA-CUOR</td> <td>1.000</td> <td>PZ</td> </tr> <tr> <td>RC1130A0</td> <td>FASCETTA 130X2,6</td> <td>2.000</td> <td>PZ</td> </tr> <tr> <td>SL1045A0</td> <td>SILICONE ANTRACITE S57 80 ml</td> <td>1.000</td> <td>PZ</td> </tr> <tr> <td>SN1000B1</td> <td>SONDA CUORE MULTIPUNTO L1550 NO RACCORDO</td> <td>1.000</td> <td>PZ</td> </tr> <tr> <td>VI1220A1</td> <td>VITE AUTOFIL. 4.2X11 TCS+ MARUTEX</td> <td>3.000</td> <td>PZ</td> </tr> </tbody> </table>	Code	Description	Qty	UOM	0H8119A0	COPERCHIO INGRESSO SONDA CUORE XEVL 316	1.000	PZ	CE1037A0	GUAINA UL IN FIBRA DI VETRO SILICONICA	0.600	M	CE1685A0	MORSETTO FEMMINA ESTR. MRT8 P3,81 5P	1.000	PZ	GN1632A0	GUARNIZIONE TENUTA INGRESSO SONDA-CUOR	1.000	PZ	RC1130A0	FASCETTA 130X2,6	2.000	PZ	SL1045A0	SILICONE ANTRACITE S57 80 ml	1.000	PZ	SN1000B1	SONDA CUORE MULTIPUNTO L1550 NO RACCORDO	1.000	PZ	VI1220A1	VITE AUTOFIL. 4.2X11 TCS+ MARUTEX	3.000	PZ	<table border="1"> <thead> <tr> <th>Code</th> <th>Description</th> <th>Qty</th> <th>UOM</th> </tr> </thead> <tbody> <tr> <td>0H8119A0</td> <td>COPERCHIO INGRESSO SONDA CUORE XEVL 316</td> <td>1.000</td> <td>PZ</td> </tr> <tr> <td>CE1685A0</td> <td>MORSETTO FEMMINA ESTR. MRT8 P3,81 5P</td> <td>1.000</td> <td>PZ</td> </tr> <tr> <td>GN1632A0</td> <td>GUARNIZIONE TENUTA INGRESSO SONDA-CUOR</td> <td>1.000</td> <td>PZ</td> </tr> </tbody> </table>	Code	Description	Qty	UOM	0H8119A0	COPERCHIO INGRESSO SONDA CUORE XEVL 316	1.000	PZ	CE1685A0	MORSETTO FEMMINA ESTR. MRT8 P3,81 5P	1.000	PZ	GN1632A0	GUARNIZIONE TENUTA INGRESSO SONDA-CUOR	1.000	PZ
			Code	Description	Qty	UOM																																																																	
			SN1002B2	SONDA CUORE MULTIP DRITTA L2050 NO RACC	1.000	PZ																																																																	
VI1220A1	VITE AUTOFIL. 4.2X11 TCS+ MARUTEX	3.000	PZ																																																																				
Code	Description	Qty	UOM																																																																				
0H8119A0	COPERCHIO INGRESSO SONDA CUORE XEVL 316	1.000	PZ																																																																				
CE1037A0	GUAINA UL IN FIBRA DI VETRO SILICONICA	0.600	M																																																																				
CE1685A0	MORSETTO FEMMINA ESTR. MRT8 P3,81 5P	1.000	PZ																																																																				
GN1632A0	GUARNIZIONE TENUTA INGRESSO SONDA-CUOR	1.000	PZ																																																																				
RC1130A0	FASCETTA 130X2,6	2.000	PZ																																																																				
SL1045A0	SILICONE ANTRACITE S57 80 ml	1.000	PZ																																																																				
SN1000B1	SONDA CUORE MULTIPUNTO L1550 NO RACCORDO	1.000	PZ																																																																				
VI1220A1	VITE AUTOFIL. 4.2X11 TCS+ MARUTEX	3.000	PZ																																																																				
Code	Description	Qty	UOM																																																																				
0H8119A0	COPERCHIO INGRESSO SONDA CUORE XEVL 316	1.000	PZ																																																																				
CE1685A0	MORSETTO FEMMINA ESTR. MRT8 P3,81 5P	1.000	PZ																																																																				
GN1632A0	GUARNIZIONE TENUTA INGRESSO SONDA-CUOR	1.000	PZ																																																																				
			KSN1019B	US MULTI.POINT L1550 CORE PROBE KIT																																																																			
			KSN1012B	MULTIPOINT CORE PROBE KIT L2750																																																																			

COMPONENT			SPARE PART																														
Code	Description	Image	Code	Description	Kit components																												
GN1632A	GUARNIZIONE TENUTA INGRESSO SONDA-CUORE		KSN1012B	MULTIPOINT CORE PROBE KIT L2750	<table border="1"> <thead> <tr> <th>Code</th> <th>Description</th> <th>Qty</th> <th>UOM</th> </tr> </thead> <tbody> <tr> <td>SL1045A0</td> <td>SILICONE ANTRACITE S57 80 ml</td> <td>1.000</td> <td>PZ</td> </tr> <tr> <td>SN1012B1</td> <td>SONDA CUORE MULTIPUNTO L2750 NO RACCORDO</td> <td>1.000</td> <td>PZ</td> </tr> <tr> <td>VI1220A1</td> <td>VITE AUTOFIL. 4.2X11 TCS+ MARUTEX</td> <td>3.000</td> <td>PZ</td> </tr> </tbody> </table>	Code	Description	Qty	UOM	SL1045A0	SILICONE ANTRACITE S57 80 ml	1.000	PZ	SN1012B1	SONDA CUORE MULTIPUNTO L2750 NO RACCORDO	1.000	PZ	VI1220A1	VITE AUTOFIL. 4.2X11 TCS+ MARUTEX	3.000	PZ												
			Code	Description	Qty	UOM																											
			SL1045A0	SILICONE ANTRACITE S57 80 ml	1.000	PZ																											
			SN1012B1	SONDA CUORE MULTIPUNTO L2750 NO RACCORDO	1.000	PZ																											
			VI1220A1	VITE AUTOFIL. 4.2X11 TCS+ MARUTEX	3.000	PZ																											
			KSN1002B	MULTIPOINT CORE PROBE KIT L2050	<table border="1"> <thead> <tr> <th>Code</th> <th>Description</th> <th>Qty</th> <th>UOM</th> </tr> </thead> <tbody> <tr> <td>0H8119A0</td> <td>COPERCHIO INGRESSO SONDA CUORE XEVL 316</td> <td>1.000</td> <td>PZ</td> </tr> <tr> <td>CE1685A0</td> <td>MORSETTO FEMMINA ESTR. MRT8 P3,81 5P</td> <td>1.000</td> <td>PZ</td> </tr> <tr> <td>GN1632A0</td> <td>GUARNIZIONE TENUTA INGRESSO SONDA-CUOR</td> <td>1.000</td> <td>PZ</td> </tr> <tr> <td>SL1045A0</td> <td>SILICONE ANTRACITE S57 80 ml</td> <td>1.000</td> <td>PZ</td> </tr> <tr> <td>SN1002B2</td> <td>SONDA CUORE MULTIP DRITTA L2050 NO RACC</td> <td>1.000</td> <td>PZ</td> </tr> <tr> <td>VI1220A1</td> <td>VITE AUTOFIL. 4.2X11 TCS+ MARUTEX</td> <td>3.000</td> <td>PZ</td> </tr> </tbody> </table>	Code	Description	Qty	UOM	0H8119A0	COPERCHIO INGRESSO SONDA CUORE XEVL 316	1.000	PZ	CE1685A0	MORSETTO FEMMINA ESTR. MRT8 P3,81 5P	1.000	PZ	GN1632A0	GUARNIZIONE TENUTA INGRESSO SONDA-CUOR	1.000	PZ	SL1045A0	SILICONE ANTRACITE S57 80 ml	1.000	PZ	SN1002B2	SONDA CUORE MULTIP DRITTA L2050 NO RACC	1.000	PZ	VI1220A1	VITE AUTOFIL. 4.2X11 TCS+ MARUTEX	3.000	PZ
			Code	Description	Qty	UOM																											
			0H8119A0	COPERCHIO INGRESSO SONDA CUORE XEVL 316	1.000	PZ																											
			CE1685A0	MORSETTO FEMMINA ESTR. MRT8 P3,81 5P	1.000	PZ																											
			GN1632A0	GUARNIZIONE TENUTA INGRESSO SONDA-CUOR	1.000	PZ																											
			SL1045A0	SILICONE ANTRACITE S57 80 ml	1.000	PZ																											
			SN1002B2	SONDA CUORE MULTIP DRITTA L2050 NO RACC	1.000	PZ																											
VI1220A1	VITE AUTOFIL. 4.2X11 TCS+ MARUTEX	3.000	PZ																														
KSN1000B	MULTIPOINT CORE PROBE KIT L1550	<table border="1"> <thead> <tr> <th>Code</th> <th>Description</th> <th>Qty</th> <th>UOM</th> </tr> </thead> <tbody> <tr> <td>0H8119A0</td> <td>COPERCHIO INGRESSO SONDA CUORE XEVL 316</td> <td>1.000</td> <td>PZ</td> </tr> <tr> <td>CE1685A0</td> <td>MORSETTO FEMMINA ESTR. MRT8 P3,81 5P</td> <td>1.000</td> <td>PZ</td> </tr> <tr> <td>GN1632A0</td> <td>GUARNIZIONE TENUTA INGRESSO SONDA-CUOR</td> <td>1.000</td> <td>PZ</td> </tr> <tr> <td>SL1045A0</td> <td>SILICONE ANTRACITE S57 80 ml</td> <td>1.000</td> <td>PZ</td> </tr> </tbody> </table>	Code	Description	Qty	UOM	0H8119A0	COPERCHIO INGRESSO SONDA CUORE XEVL 316	1.000	PZ	CE1685A0	MORSETTO FEMMINA ESTR. MRT8 P3,81 5P	1.000	PZ	GN1632A0	GUARNIZIONE TENUTA INGRESSO SONDA-CUOR	1.000	PZ	SL1045A0	SILICONE ANTRACITE S57 80 ml	1.000	PZ											
Code	Description	Qty	UOM																														
0H8119A0	COPERCHIO INGRESSO SONDA CUORE XEVL 316	1.000	PZ																														
CE1685A0	MORSETTO FEMMINA ESTR. MRT8 P3,81 5P	1.000	PZ																														
GN1632A0	GUARNIZIONE TENUTA INGRESSO SONDA-CUOR	1.000	PZ																														
SL1045A0	SILICONE ANTRACITE S57 80 ml	1.000	PZ																														

COMPONENT			SPARE PART														
Code	Description	Image	Code	Description	Kit components												
GN1632A	GUARNIZIONE TENUTA INGRESSO SONDA-CUORE		KSN1000B	MULTIPOINT CORE PROBE KIT L1550	<table border="1"> <thead> <tr> <th>Code</th> <th>Description</th> <th>Qty</th> <th>UOM</th> </tr> </thead> <tbody> <tr> <td>SN1000B1</td> <td>SONDA CUORE MULTIPUNTO L1550 NO RACCORDO</td> <td>1.000</td> <td>PZ</td> </tr> <tr> <td>VI1220A1</td> <td>VITE AUTOFIL. 4.2X11 TCS+ MARUTEX</td> <td>3.000</td> <td>PZ</td> </tr> </tbody> </table>	Code	Description	Qty	UOM	SN1000B1	SONDA CUORE MULTIPUNTO L1550 NO RACCORDO	1.000	PZ	VI1220A1	VITE AUTOFIL. 4.2X11 TCS+ MARUTEX	3.000	PZ
Code	Description	Qty	UOM														
SN1000B1	SONDA CUORE MULTIPUNTO L1550 NO RACCORDO	1.000	PZ														
VI1220A1	VITE AUTOFIL. 4.2X11 TCS+ MARUTEX	3.000	PZ														
RC1019A	FASCETTA ELASTICA D10 ZINCATA		KRC1019A	Ø10 ZINC PLATED ELASTIC CLAMP 15 PCS KIT	<table border="1"> <thead> <tr> <th>Code</th> <th>Description</th> <th>Qty</th> <th>UOM</th> </tr> </thead> <tbody> <tr> <td>RC1019A0</td> <td>FASCETTA ELASTICA D10 ZINCATA</td> <td>15.000</td> <td>PZ</td> </tr> </tbody> </table>	Code	Description	Qty	UOM	RC1019A0	FASCETTA ELASTICA D10 ZINCATA	15.000	PZ				
Code	Description	Qty	UOM														
RC1019A0	FASCETTA ELASTICA D10 ZINCATA	15.000	PZ														
VL1037A	GIRANTE LAVAGGIO		KVL1037A	WASHING SYSTEM ROTOR ARM KIT	<table border="1"> <thead> <tr> <th>Code</th> <th>Description</th> <th>Qty</th> <th>UOM</th> </tr> </thead> <tbody> <tr> <td>VL1037A3</td> <td>GIRANTE LAVAGGIO</td> <td>1.000</td> <td>PZ</td> </tr> </tbody> </table>	Code	Description	Qty	UOM	VL1037A3	GIRANTE LAVAGGIO	1.000	PZ				
Code	Description	Qty	UOM														
VL1037A3	GIRANTE LAVAGGIO	1.000	PZ														
GN1629A	GN1626A- GUARNIZIONE PORTA 0511 1984M		KGN1629A	0511 DOOR GASKET KIT	<table border="1"> <thead> <tr> <th>Code</th> <th>Description</th> <th>Qty</th> <th>UOM</th> </tr> </thead> <tbody> <tr> <td>GN1629A0</td> <td>GN1626A- GUARNIZIONE PORTA 0511 1984MM</td> <td>1.000</td> <td>PZ</td> </tr> <tr> <td>VM2277A0</td> <td>SPINA KIT GUARNIZIONE PORTA</td> <td>1.000</td> <td>PZ</td> </tr> </tbody> </table>	Code	Description	Qty	UOM	GN1629A0	GN1626A- GUARNIZIONE PORTA 0511 1984MM	1.000	PZ	VM2277A0	SPINA KIT GUARNIZIONE PORTA	1.000	PZ
Code	Description	Qty	UOM														
GN1629A0	GN1626A- GUARNIZIONE PORTA 0511 1984MM	1.000	PZ														
VM2277A0	SPINA KIT GUARNIZIONE PORTA	1.000	PZ														
VM1541A	VM1541A1		VM1541A1	VM1541A1													

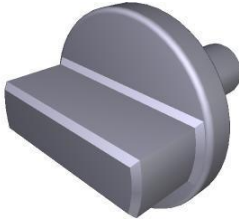

COMPONENT			SPARE PART										
Code	Description	Image	Code	Description	Kit components								
VM1820A	NOTTOLINO M6 CROMATO FISS. SUPPORTI		KVM1820A	THUMB SCREW 10PCS KIT	<table border="1"> <thead> <tr> <th>Code</th> <th>Description</th> <th>Qty</th> <th>UOM</th> </tr> </thead> <tbody> <tr> <td>VM1820A0</td> <td>NOTTOLINO M6 CROMATO FISS. SUPPORTI</td> <td>10.000</td> <td>PZ</td> </tr> </tbody> </table>	Code	Description	Qty	UOM	VM1820A0	NOTTOLINO M6 CROMATO FISS. SUPPORTI	10.000	PZ
Code	Description	Qty	UOM										
VM1820A0	NOTTOLINO M6 CROMATO FISS. SUPPORTI	10.000	PZ										



ASM2916C/0.D07 - External cover - FRONT









ASM2916C/0.D07 - External cover - REAR





COMPONENT			SPARE PART														
Code	Description	Image	Code	Description	Kit components												
0D2295A	X*VC-GN11-E* TOP PANEL		K0D2295A	XEVC GN1-1 EXT COVER KIT	<table border="1"> <thead> <tr> <th>Code</th> <th>Description</th> <th>Qty</th> <th>UOM</th> </tr> </thead> <tbody> <tr> <td>0D2295A2</td> <td>COPERCHIO XEVC GN1-1</td> <td>1.000</td> <td>PZ</td> </tr> <tr> <td>VM1411A0</td> <td>FILM TERMORETR 30MY 680 MM MICROF 200 M</td> <td>1.000</td> <td>M</td> </tr> </tbody> </table>	Code	Description	Qty	UOM	0D2295A2	COPERCHIO XEVC GN1-1	1.000	PZ	VM1411A0	FILM TERMORETR 30MY 680 MM MICROF 200 M	1.000	M
Code	Description	Qty	UOM														
0D2295A2	COPERCHIO XEVC GN1-1	1.000	PZ														
VM1411A0	FILM TERMORETR 30MY 680 MM MICROF 200 M	1.000	M														
0D2298A	X*VC-0511 LEFT PANEL		0D2298A3	X*VC-0511 LEFT PANEL													
0D2299A	X*VC-0511 RIGHT PANEL		0D2299A3	X*VC-0511 RIGHT PANEL													
0E1350C	GN1-1 XEVC EXTERNAL BOTTOM PANEL		0E1350C3	GN1-1 XEVC EXTERNAL BOTTOM PANEL													
0F1496A	XEVC-0511-E BACK PANEL		0F1496A1	XEVC-0511-E BACK PANEL													





COMPONENT			SPARE PART																						
Code	Description	Image	Code	Description	Kit components																				
VM1750A	MORSETTO A PETTINE		KVM1750A	COMB TERMINAL BLOCK KIT	<table border="1"> <thead> <tr> <th>Code</th> <th>Description</th> <th>Qty</th> <th>UOM</th> </tr> </thead> <tbody> <tr> <td>V11040A0</td> <td>ROSETTA DENTELLATA INTERNA ø6 Z</td> <td>2.000</td> <td>PZ</td> </tr> <tr> <td>VM1750A0</td> <td>MORSETTO A PETTINE</td> <td>1.000</td> <td>PZ</td> </tr> </tbody> </table>	Code	Description	Qty	UOM	V11040A0	ROSETTA DENTELLATA INTERNA ø6 Z	2.000	PZ	VM1750A0	MORSETTO A PETTINE	1.000	PZ								
Code	Description	Qty	UOM																						
V11040A0	ROSETTA DENTELLATA INTERNA ø6 Z	2.000	PZ																						
VM1750A0	MORSETTO A PETTINE	1.000	PZ																						
VM1630A	TAPPO PREMI VETRO INTERNO		KVM1630A	CAP FOR INTERNAL GLASS 10 PCS KIT	<table border="1"> <thead> <tr> <th>Code</th> <th>Description</th> <th>Qty</th> <th>UOM</th> </tr> </thead> <tbody> <tr> <td>VM1630A1</td> <td>TAPPO PREMI VETRO INTERNO</td> <td>10.000</td> <td>PZ</td> </tr> </tbody> </table>	Code	Description	Qty	UOM	VM1630A1	TAPPO PREMI VETRO INTERNO	10.000	PZ												
Code	Description	Qty	UOM																						
VM1630A1	TAPPO PREMI VETRO INTERNO	10.000	PZ																						
VM2280B	PIASTRINA COPRI SCROCCO		KVM2280B	VM2280B -M HANDLE LATCH PLATE COVER KIT	<table border="1"> <thead> <tr> <th>Code</th> <th>Description</th> <th>Qty</th> <th>UOM</th> </tr> </thead> <tbody> <tr> <td>V11074A0</td> <td>VITE PER PLASTICA 4X16 TPBS+ INOX</td> <td>2.000</td> <td>PZ</td> </tr> <tr> <td>VM1630A1</td> <td>TAPPO PREMI VETRO INTERNO</td> <td>2.000</td> <td>PZ</td> </tr> <tr> <td>VM2280B0</td> <td>PIASTRINA COPRI SCROCCO</td> <td>1.000</td> <td>PZ</td> </tr> </tbody> </table>	Code	Description	Qty	UOM	V11074A0	VITE PER PLASTICA 4X16 TPBS+ INOX	2.000	PZ	VM1630A1	TAPPO PREMI VETRO INTERNO	2.000	PZ	VM2280B0	PIASTRINA COPRI SCROCCO	1.000	PZ				
Code	Description	Qty	UOM																						
V11074A0	VITE PER PLASTICA 4X16 TPBS+ INOX	2.000	PZ																						
VM1630A1	TAPPO PREMI VETRO INTERNO	2.000	PZ																						
VM2280B0	PIASTRINA COPRI SCROCCO	1.000	PZ																						
VP1530A	SCROCCO MANIGLIA DX CT BT		KVM1190A	CHEFTOP/BAKERTO P DOOR RIGHT LATCH KIT	<table border="1"> <thead> <tr> <th>Code</th> <th>Description</th> <th>Qty</th> <th>UOM</th> </tr> </thead> <tbody> <tr> <td>V11074A0</td> <td>VITE PER PLASTICA 4X16 TPBS+ INOX</td> <td>2.000</td> <td>PZ</td> </tr> <tr> <td>V11220A1</td> <td>VITE AUTOFIL. 4.2X11 TCS+ MARUTEX</td> <td>2.000</td> <td>PZ</td> </tr> <tr> <td>VM1460A0</td> <td>COPERCHIO DX SCROCCO PORTA XBC/XVC</td> <td>1.000</td> <td>PZ</td> </tr> <tr> <td>VP1530A0</td> <td>SCROCCO MANIGLIA DX CT BT</td> <td>1.000</td> <td>PZ</td> </tr> </tbody> </table>	Code	Description	Qty	UOM	V11074A0	VITE PER PLASTICA 4X16 TPBS+ INOX	2.000	PZ	V11220A1	VITE AUTOFIL. 4.2X11 TCS+ MARUTEX	2.000	PZ	VM1460A0	COPERCHIO DX SCROCCO PORTA XBC/XVC	1.000	PZ	VP1530A0	SCROCCO MANIGLIA DX CT BT	1.000	PZ
Code	Description	Qty	UOM																						
V11074A0	VITE PER PLASTICA 4X16 TPBS+ INOX	2.000	PZ																						
V11220A1	VITE AUTOFIL. 4.2X11 TCS+ MARUTEX	2.000	PZ																						
VM1460A0	COPERCHIO DX SCROCCO PORTA XBC/XVC	1.000	PZ																						
VP1530A0	SCROCCO MANIGLIA DX CT BT	1.000	PZ																						

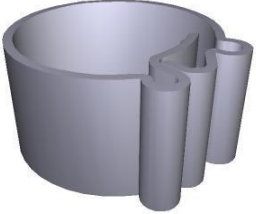

COMPONENT			SPARE PART																						
Code	Description	Image	Code	Description	Kit components																				
VM1190A	CT BT RIGHT DOOR SPRING LATCH		KVM1190A	CHEFTOP/BAKERTO P DOOR RIGHT LATCH KIT	<table border="1"> <thead> <tr> <th>Code</th> <th>Description</th> <th>Qty</th> <th>UOM</th> </tr> </thead> <tbody> <tr> <td>VI1074A0</td> <td>VITE PER PLASTICA 4X16 TPBS+ INOX</td> <td>2.000</td> <td>PZ</td> </tr> <tr> <td>VI1220A1</td> <td>VITE AUTOFIL. 4.2X11 TCS+ MARUTEX</td> <td>2.000</td> <td>PZ</td> </tr> <tr> <td>VM1460A0</td> <td>COPERCHIO DX SCROCCO PORTA XBC/XVC</td> <td>1.000</td> <td>PZ</td> </tr> <tr> <td>VP1530A0</td> <td>SCROCCO MANIGLIA DX CT BT</td> <td>1.000</td> <td>PZ</td> </tr> </tbody> </table>	Code	Description	Qty	UOM	VI1074A0	VITE PER PLASTICA 4X16 TPBS+ INOX	2.000	PZ	VI1220A1	VITE AUTOFIL. 4.2X11 TCS+ MARUTEX	2.000	PZ	VM1460A0	COPERCHIO DX SCROCCO PORTA XBC/XVC	1.000	PZ	VP1530A0	SCROCCO MANIGLIA DX CT BT	1.000	PZ
					Code	Description	Qty	UOM																	
VI1074A0	VITE PER PLASTICA 4X16 TPBS+ INOX	2.000	PZ																						
VI1220A1	VITE AUTOFIL. 4.2X11 TCS+ MARUTEX	2.000	PZ																						
VM1460A0	COPERCHIO DX SCROCCO PORTA XBC/XVC	1.000	PZ																						
VP1530A0	SCROCCO MANIGLIA DX CT BT	1.000	PZ																						
<table border="1"> <thead> <tr> <th>Code</th> <th>Description</th> <th>Qty</th> <th>UOM</th> </tr> </thead> <tbody> <tr> <td>VI1074A0</td> <td>VITE PER PLASTICA 4X16 TPBS+ INOX</td> <td>2.000</td> <td>PZ</td> </tr> <tr> <td>VI1220A1</td> <td>VITE AUTOFIL. 4.2X11 TCS+ MARUTEX</td> <td>2.000</td> <td>PZ</td> </tr> <tr> <td>VM1460A0</td> <td>COPERCHIO DX SCROCCO PORTA XBC/XVC</td> <td>1.000</td> <td>PZ</td> </tr> <tr> <td>VP1531A0</td> <td>SCROCCO MANIGLIA SX CT BT</td> <td>1.000</td> <td>PZ</td> </tr> </tbody> </table>	Code	Description	Qty	UOM	VI1074A0	VITE PER PLASTICA 4X16 TPBS+ INOX	2.000	PZ	VI1220A1	VITE AUTOFIL. 4.2X11 TCS+ MARUTEX	2.000	PZ	VM1460A0	COPERCHIO DX SCROCCO PORTA XBC/XVC	1.000	PZ	VP1531A0	SCROCCO MANIGLIA SX CT BT	1.000	PZ					
Code	Description	Qty	UOM																						
VI1074A0	VITE PER PLASTICA 4X16 TPBS+ INOX	2.000	PZ																						
VI1220A1	VITE AUTOFIL. 4.2X11 TCS+ MARUTEX	2.000	PZ																						
VM1460A0	COPERCHIO DX SCROCCO PORTA XBC/XVC	1.000	PZ																						
VP1531A0	SCROCCO MANIGLIA SX CT BT	1.000	PZ																						
VM1192A	CT BT DOOR SPRING LATCH BACK COVER		KVM1191A	CHEFTOP/BAKERTO P DOOR LEFT LATCH KIT	<table border="1"> <thead> <tr> <th>Code</th> <th>Description</th> <th>Qty</th> <th>UOM</th> </tr> </thead> <tbody> <tr> <td>VI1074A0</td> <td>VITE PER PLASTICA 4X16 TPBS+ INOX</td> <td>2.000</td> <td>PZ</td> </tr> <tr> <td>VI1220A1</td> <td>VITE AUTOFIL. 4.2X11 TCS+ MARUTEX</td> <td>2.000</td> <td>PZ</td> </tr> <tr> <td>VM1460A0</td> <td>COPERCHIO DX SCROCCO PORTA XBC/XVC</td> <td>1.000</td> <td>PZ</td> </tr> <tr> <td>VP1531A0</td> <td>SCROCCO MANIGLIA SX CT BT</td> <td>1.000</td> <td>PZ</td> </tr> </tbody> </table>	Code	Description	Qty	UOM	VI1074A0	VITE PER PLASTICA 4X16 TPBS+ INOX	2.000	PZ	VI1220A1	VITE AUTOFIL. 4.2X11 TCS+ MARUTEX	2.000	PZ	VM1460A0	COPERCHIO DX SCROCCO PORTA XBC/XVC	1.000	PZ	VP1531A0	SCROCCO MANIGLIA SX CT BT	1.000	PZ
					Code	Description	Qty	UOM																	
VI1074A0	VITE PER PLASTICA 4X16 TPBS+ INOX	2.000	PZ																						
VI1220A1	VITE AUTOFIL. 4.2X11 TCS+ MARUTEX	2.000	PZ																						
VM1460A0	COPERCHIO DX SCROCCO PORTA XBC/XVC	1.000	PZ																						
VP1531A0	SCROCCO MANIGLIA SX CT BT	1.000	PZ																						
<table border="1"> <thead> <tr> <th>Code</th> <th>Description</th> <th>Qty</th> <th>UOM</th> </tr> </thead> <tbody> <tr> <td>VI1074A0</td> <td>VITE PER PLASTICA 4X16 TPBS+ INOX</td> <td>2.000</td> <td>PZ</td> </tr> <tr> <td>VI1220A1</td> <td>VITE AUTOFIL. 4.2X11 TCS+ MARUTEX</td> <td>2.000</td> <td>PZ</td> </tr> <tr> <td>VM1460A0</td> <td>COPERCHIO DX SCROCCO PORTA XBC/XVC</td> <td>1.000</td> <td>PZ</td> </tr> <tr> <td>VP1530A0</td> <td>SCROCCO MANIGLIA DX CT BT</td> <td>1.000</td> <td>PZ</td> </tr> </tbody> </table>	Code	Description	Qty	UOM	VI1074A0	VITE PER PLASTICA 4X16 TPBS+ INOX	2.000	PZ	VI1220A1	VITE AUTOFIL. 4.2X11 TCS+ MARUTEX	2.000	PZ	VM1460A0	COPERCHIO DX SCROCCO PORTA XBC/XVC	1.000	PZ	VP1530A0	SCROCCO MANIGLIA DX CT BT	1.000	PZ					
Code	Description	Qty	UOM																						
VI1074A0	VITE PER PLASTICA 4X16 TPBS+ INOX	2.000	PZ																						
VI1220A1	VITE AUTOFIL. 4.2X11 TCS+ MARUTEX	2.000	PZ																						
VM1460A0	COPERCHIO DX SCROCCO PORTA XBC/XVC	1.000	PZ																						
VP1530A0	SCROCCO MANIGLIA DX CT BT	1.000	PZ																						
			KVM1190A	CHEFTOP/BAKERTO P DOOR RIGHT LATCH KIT	<table border="1"> <thead> <tr> <th>Code</th> <th>Description</th> <th>Qty</th> <th>UOM</th> </tr> </thead> <tbody> <tr> <td>VI1074A0</td> <td>VITE PER PLASTICA 4X16 TPBS+ INOX</td> <td>2.000</td> <td>PZ</td> </tr> <tr> <td>VI1220A1</td> <td>VITE AUTOFIL. 4.2X11 TCS+ MARUTEX</td> <td>2.000</td> <td>PZ</td> </tr> <tr> <td>VM1460A0</td> <td>COPERCHIO DX SCROCCO PORTA XBC/XVC</td> <td>1.000</td> <td>PZ</td> </tr> <tr> <td>VP1530A0</td> <td>SCROCCO MANIGLIA DX CT BT</td> <td>1.000</td> <td>PZ</td> </tr> </tbody> </table>	Code	Description	Qty	UOM	VI1074A0	VITE PER PLASTICA 4X16 TPBS+ INOX	2.000	PZ	VI1220A1	VITE AUTOFIL. 4.2X11 TCS+ MARUTEX	2.000	PZ	VM1460A0	COPERCHIO DX SCROCCO PORTA XBC/XVC	1.000	PZ	VP1530A0	SCROCCO MANIGLIA DX CT BT	1.000	PZ
Code	Description	Qty	UOM																						
VI1074A0	VITE PER PLASTICA 4X16 TPBS+ INOX	2.000	PZ																						
VI1220A1	VITE AUTOFIL. 4.2X11 TCS+ MARUTEX	2.000	PZ																						
VM1460A0	COPERCHIO DX SCROCCO PORTA XBC/XVC	1.000	PZ																						
VP1530A0	SCROCCO MANIGLIA DX CT BT	1.000	PZ																						

COMPONENT			SPARE PART																						
Code	Description	Image	Code	Description	Kit components																				
VM2281A	PIASTRINA COPRI FORI		KVM2281A	HOLE PLATE COVER KIT	<table border="1"> <thead> <tr> <th>Code</th> <th>Description</th> <th>Qty</th> <th>UOM</th> </tr> </thead> <tbody> <tr> <td>VM2281A0</td> <td>PIASTRINA COPRI FORI</td> <td>1.000</td> <td>PZ</td> </tr> </tbody> </table>	Code	Description	Qty	UOM	VM2281A0	PIASTRINA COPRI FORI	1.000	PZ												
Code	Description	Qty	UOM																						
VM2281A0	PIASTRINA COPRI FORI	1.000	PZ																						
VP1531A	SCROCCO MANIGLIA SX CT BT		KVM1191A	CHEFTOP/BAKERTO P DOOR LEFT LATCH KIT	<table border="1"> <thead> <tr> <th>Code</th> <th>Description</th> <th>Qty</th> <th>UOM</th> </tr> </thead> <tbody> <tr> <td>VI1074A0</td> <td>VITE PER PLASTICA 4X16 TPBS+ INOX</td> <td>2.000</td> <td>PZ</td> </tr> <tr> <td>VI1220A1</td> <td>VITE AUTOFIL. 4.2X11 TCS+ MARUTEX</td> <td>2.000</td> <td>PZ</td> </tr> <tr> <td>VM1460A0</td> <td>COPERCHIO DX SCROCCO PORTA XBC/XVC</td> <td>1.000</td> <td>PZ</td> </tr> <tr> <td>VP1531A0</td> <td>SCROCCO MANIGLIA SX CT BT</td> <td>1.000</td> <td>PZ</td> </tr> </tbody> </table>	Code	Description	Qty	UOM	VI1074A0	VITE PER PLASTICA 4X16 TPBS+ INOX	2.000	PZ	VI1220A1	VITE AUTOFIL. 4.2X11 TCS+ MARUTEX	2.000	PZ	VM1460A0	COPERCHIO DX SCROCCO PORTA XBC/XVC	1.000	PZ	VP1531A0	SCROCCO MANIGLIA SX CT BT	1.000	PZ
Code	Description	Qty	UOM																						
VI1074A0	VITE PER PLASTICA 4X16 TPBS+ INOX	2.000	PZ																						
VI1220A1	VITE AUTOFIL. 4.2X11 TCS+ MARUTEX	2.000	PZ																						
VM1460A0	COPERCHIO DX SCROCCO PORTA XBC/XVC	1.000	PZ																						
VP1531A0	SCROCCO MANIGLIA SX CT BT	1.000	PZ																						
VM1191A	CT BT LEFT DOOR SPRING LATCH		KVM1191A	CHEFTOP/BAKERTO P DOOR LEFT LATCH KIT	<table border="1"> <thead> <tr> <th>Code</th> <th>Description</th> <th>Qty</th> <th>UOM</th> </tr> </thead> <tbody> <tr> <td>VI1074A0</td> <td>VITE PER PLASTICA 4X16 TPBS+ INOX</td> <td>2.000</td> <td>PZ</td> </tr> <tr> <td>VI1220A1</td> <td>VITE AUTOFIL. 4.2X11 TCS+ MARUTEX</td> <td>2.000</td> <td>PZ</td> </tr> <tr> <td>VM1460A0</td> <td>COPERCHIO DX SCROCCO PORTA XBC/XVC</td> <td>1.000</td> <td>PZ</td> </tr> <tr> <td>VP1531A0</td> <td>SCROCCO MANIGLIA SX CT BT</td> <td>1.000</td> <td>PZ</td> </tr> </tbody> </table>	Code	Description	Qty	UOM	VI1074A0	VITE PER PLASTICA 4X16 TPBS+ INOX	2.000	PZ	VI1220A1	VITE AUTOFIL. 4.2X11 TCS+ MARUTEX	2.000	PZ	VM1460A0	COPERCHIO DX SCROCCO PORTA XBC/XVC	1.000	PZ	VP1531A0	SCROCCO MANIGLIA SX CT BT	1.000	PZ
Code	Description	Qty	UOM																						
VI1074A0	VITE PER PLASTICA 4X16 TPBS+ INOX	2.000	PZ																						
VI1220A1	VITE AUTOFIL. 4.2X11 TCS+ MARUTEX	2.000	PZ																						
VM1460A0	COPERCHIO DX SCROCCO PORTA XBC/XVC	1.000	PZ																						
VP1531A0	SCROCCO MANIGLIA SX CT BT	1.000	PZ																						
VM1192A	CT BT DOOR SPRING LATCH BACK COVER		KVM1191A	CHEFTOP/BAKERTO P DOOR LEFT LATCH KIT	<table border="1"> <thead> <tr> <th>Code</th> <th>Description</th> <th>Qty</th> <th>UOM</th> </tr> </thead> <tbody> <tr> <td>VI1074A0</td> <td>VITE PER PLASTICA 4X16 TPBS+ INOX</td> <td>2.000</td> <td>PZ</td> </tr> <tr> <td>VI1220A1</td> <td>VITE AUTOFIL. 4.2X11 TCS+ MARUTEX</td> <td>2.000</td> <td>PZ</td> </tr> <tr> <td>VM1460A0</td> <td>COPERCHIO DX SCROCCO PORTA XBC/XVC</td> <td>1.000</td> <td>PZ</td> </tr> <tr> <td>VP1531A0</td> <td>SCROCCO MANIGLIA SX CT BT</td> <td>1.000</td> <td>PZ</td> </tr> </tbody> </table>	Code	Description	Qty	UOM	VI1074A0	VITE PER PLASTICA 4X16 TPBS+ INOX	2.000	PZ	VI1220A1	VITE AUTOFIL. 4.2X11 TCS+ MARUTEX	2.000	PZ	VM1460A0	COPERCHIO DX SCROCCO PORTA XBC/XVC	1.000	PZ	VP1531A0	SCROCCO MANIGLIA SX CT BT	1.000	PZ
Code	Description	Qty	UOM																						
VI1074A0	VITE PER PLASTICA 4X16 TPBS+ INOX	2.000	PZ																						
VI1220A1	VITE AUTOFIL. 4.2X11 TCS+ MARUTEX	2.000	PZ																						
VM1460A0	COPERCHIO DX SCROCCO PORTA XBC/XVC	1.000	PZ																						
VP1531A0	SCROCCO MANIGLIA SX CT BT	1.000	PZ																						

COMPONENT			SPARE PART																																														
Code	Description	Image	Code	Description	Kit components																																												
VM1192A	CT BT DOOR SPRING LATCH BACK COVER		KVM1190A	CHEFTOP/BAKERTO P DOOR RIGHT LATCH KIT	<table border="1"> <thead> <tr> <th>Code</th> <th>Description</th> <th>Qty</th> <th>UOM</th> </tr> </thead> <tbody> <tr> <td>VI1074A0</td> <td>VITE PER PLASTICA 4X16 TPBS+ INOX</td> <td>2.000</td> <td>PZ</td> </tr> <tr> <td>VI1220A1</td> <td>VITE AUTOFIL. 4.2X11 TCS+ MARUTEX</td> <td>2.000</td> <td>PZ</td> </tr> <tr> <td>VM1460A0</td> <td>COPERCHIO DX SCROCCO PORTA XBC/XVC</td> <td>1.000</td> <td>PZ</td> </tr> <tr> <td>VP1530A0</td> <td>SCROCCO MANIGLIA DX CT BT</td> <td>1.000</td> <td>PZ</td> </tr> </tbody> </table>	Code	Description	Qty	UOM	VI1074A0	VITE PER PLASTICA 4X16 TPBS+ INOX	2.000	PZ	VI1220A1	VITE AUTOFIL. 4.2X11 TCS+ MARUTEX	2.000	PZ	VM1460A0	COPERCHIO DX SCROCCO PORTA XBC/XVC	1.000	PZ	VP1530A0	SCROCCO MANIGLIA DX CT BT	1.000	PZ																								
					Code	Description	Qty	UOM																																									
					VI1074A0	VITE PER PLASTICA 4X16 TPBS+ INOX	2.000	PZ																																									
					VI1220A1	VITE AUTOFIL. 4.2X11 TCS+ MARUTEX	2.000	PZ																																									
VM1460A0	COPERCHIO DX SCROCCO PORTA XBC/XVC	1.000	PZ																																														
VP1530A0	SCROCCO MANIGLIA DX CT BT	1.000	PZ																																														
SB1015A	SERBATOIO DETERGENTE 4L + ROMPI-CIALDA		KSB1015A	4L DETERGENT TANK KIT	<table border="1"> <thead> <tr> <th>Code</th> <th>Description</th> <th>Qty</th> <th>UOM</th> </tr> </thead> <tbody> <tr> <td>SB1015A3</td> <td>SERBATOIO DETERGENTE 4L + ROMPI-CIALD</td> <td>1.000</td> <td>PZ</td> </tr> </tbody> </table>	Code	Description	Qty	UOM	SB1015A3	SERBATOIO DETERGENTE 4L + ROMPI-CIALD	1.000	PZ	VM1118A	GUIDA SX SERBATOIO DET&Rinse PLUS		KVM1118A	DET&RINSE TANK LEFT GUIDE KIT FOR MM	<table border="1"> <thead> <tr> <th>Code</th> <th>Description</th> <th>Qty</th> <th>UOM</th> </tr> </thead> <tbody> <tr> <td>VI1220A1</td> <td>VITE AUTOFIL. 4.2X11 TCS+ MARUTEX</td> <td>2.000</td> <td>PZ</td> </tr> <tr> <td>VM1118A0</td> <td>GUIDA SX SERBATOIO DET&Rinse PLUS</td> <td>1.000</td> <td>PZ</td> </tr> </tbody> </table>	Code	Description	Qty	UOM	VI1220A1	VITE AUTOFIL. 4.2X11 TCS+ MARUTEX	2.000	PZ	VM1118A0	GUIDA SX SERBATOIO DET&Rinse PLUS	1.000	PZ	VM1119A	GUIDA DX SERBATOIO DET&Rinse PLUS		KVM1119A	DET&RINSE TANK RIGHT GUIDE KIT FOR MM	<table border="1"> <thead> <tr> <th>Code</th> <th>Description</th> <th>Qty</th> <th>UOM</th> </tr> </thead> <tbody> <tr> <td>VI1220A1</td> <td>VITE AUTOFIL. 4.2X11 TCS+ MARUTEX</td> <td>2.000</td> <td>PZ</td> </tr> <tr> <td>VM1119A0</td> <td>GUIDA DX SERBATOIO DET&Rinse PLUS</td> <td>1.000</td> <td>PZ</td> </tr> </tbody> </table>	Code	Description	Qty	UOM	VI1220A1	VITE AUTOFIL. 4.2X11 TCS+ MARUTEX	2.000	PZ	VM1119A0	GUIDA DX SERBATOIO DET&Rinse PLUS	1.000	PZ
					SB1015A	SERBATOIO DETERGENTE 4L + ROMPI-CIALDA		KSB1015A	4L DETERGENT TANK KIT	<table border="1"> <thead> <tr> <th>Code</th> <th>Description</th> <th>Qty</th> <th>UOM</th> </tr> </thead> <tbody> <tr> <td>SB1015A3</td> <td>SERBATOIO DETERGENTE 4L + ROMPI-CIALD</td> <td>1.000</td> <td>PZ</td> </tr> </tbody> </table>	Code	Description	Qty						UOM	SB1015A3	SERBATOIO DETERGENTE 4L + ROMPI-CIALD	1.000	PZ	VM1118A	GUIDA SX SERBATOIO DET&Rinse PLUS		KVM1118A	DET&RINSE TANK LEFT GUIDE KIT FOR MM	<table border="1"> <thead> <tr> <th>Code</th> <th>Description</th> <th>Qty</th> <th>UOM</th> </tr> </thead> <tbody> <tr> <td>VI1220A1</td> <td>VITE AUTOFIL. 4.2X11 TCS+ MARUTEX</td> <td>2.000</td> <td>PZ</td> </tr> <tr> <td>VM1118A0</td> <td>GUIDA SX SERBATOIO DET&Rinse PLUS</td> <td>1.000</td> <td>PZ</td> </tr> </tbody> </table>	Code	Description						Qty	UOM	VI1220A1	VITE AUTOFIL. 4.2X11 TCS+ MARUTEX	2.000	PZ	VM1118A0	GUIDA SX SERBATOIO DET&Rinse PLUS	1.000	PZ	VM1119A	GUIDA DX SERBATOIO DET&Rinse PLUS	
SB1015A	SERBATOIO DETERGENTE 4L + ROMPI-CIALDA		KSB1015A	4L DETERGENT TANK KIT						<table border="1"> <thead> <tr> <th>Code</th> <th>Description</th> <th>Qty</th> <th>UOM</th> </tr> </thead> <tbody> <tr> <td>SB1015A3</td> <td>SERBATOIO DETERGENTE 4L + ROMPI-CIALD</td> <td>1.000</td> <td>PZ</td> </tr> </tbody> </table>	Code	Description	Qty	UOM	SB1015A3	SERBATOIO DETERGENTE 4L + ROMPI-CIALD	1.000	PZ	VM1118A	GUIDA SX SERBATOIO DET&Rinse PLUS		KVM1118A	DET&RINSE TANK LEFT GUIDE KIT FOR MM						<table border="1"> <thead> <tr> <th>Code</th> <th>Description</th> <th>Qty</th> <th>UOM</th> </tr> </thead> <tbody> <tr> <td>VI1220A1</td> <td>VITE AUTOFIL. 4.2X11 TCS+ MARUTEX</td> <td>2.000</td> <td>PZ</td> </tr> <tr> <td>VM1118A0</td> <td>GUIDA SX SERBATOIO DET&Rinse PLUS</td> <td>1.000</td> <td>PZ</td> </tr> </tbody> </table>	Code	Description	Qty	UOM	VI1220A1	VITE AUTOFIL. 4.2X11 TCS+ MARUTEX	2.000	PZ	VM1118A0	GUIDA SX SERBATOIO DET&Rinse PLUS	1.000	PZ	VM1119A	GUIDA DX SERBATOIO DET&Rinse PLUS		KVM1119A	DET&RINSE TANK RIGHT GUIDE KIT FOR MM			
					SB1015A	SERBATOIO DETERGENTE 4L + ROMPI-CIALDA		KSB1015A	4L DETERGENT TANK KIT	<table border="1"> <thead> <tr> <th>Code</th> <th>Description</th> <th>Qty</th> <th>UOM</th> </tr> </thead> <tbody> <tr> <td>SB1015A3</td> <td>SERBATOIO DETERGENTE 4L + ROMPI-CIALD</td> <td>1.000</td> <td>PZ</td> </tr> </tbody> </table>	Code	Description	Qty	UOM	SB1015A3	SERBATOIO DETERGENTE 4L + ROMPI-CIALD	1.000	PZ																															
Code	Description	Qty	UOM																																														
SB1015A3	SERBATOIO DETERGENTE 4L + ROMPI-CIALD	1.000	PZ																																														
VM1118A	GUIDA SX SERBATOIO DET&Rinse PLUS		KVM1118A	DET&RINSE TANK LEFT GUIDE KIT FOR MM	<table border="1"> <thead> <tr> <th>Code</th> <th>Description</th> <th>Qty</th> <th>UOM</th> </tr> </thead> <tbody> <tr> <td>VI1220A1</td> <td>VITE AUTOFIL. 4.2X11 TCS+ MARUTEX</td> <td>2.000</td> <td>PZ</td> </tr> <tr> <td>VM1118A0</td> <td>GUIDA SX SERBATOIO DET&Rinse PLUS</td> <td>1.000</td> <td>PZ</td> </tr> </tbody> </table>	Code	Description	Qty	UOM	VI1220A1	VITE AUTOFIL. 4.2X11 TCS+ MARUTEX	2.000	PZ	VM1118A0	GUIDA SX SERBATOIO DET&Rinse PLUS	1.000	PZ	VM1119A	GUIDA DX SERBATOIO DET&Rinse PLUS		KVM1119A	DET&RINSE TANK RIGHT GUIDE KIT FOR MM	<table border="1"> <thead> <tr> <th>Code</th> <th>Description</th> <th>Qty</th> <th>UOM</th> </tr> </thead> <tbody> <tr> <td>VI1220A1</td> <td>VITE AUTOFIL. 4.2X11 TCS+ MARUTEX</td> <td>2.000</td> <td>PZ</td> </tr> <tr> <td>VM1119A0</td> <td>GUIDA DX SERBATOIO DET&Rinse PLUS</td> <td>1.000</td> <td>PZ</td> </tr> </tbody> </table>	Code	Description	Qty	UOM	VI1220A1	VITE AUTOFIL. 4.2X11 TCS+ MARUTEX	2.000	PZ	VM1119A0	GUIDA DX SERBATOIO DET&Rinse PLUS	1.000	PZ														
					VM1118A	GUIDA SX SERBATOIO DET&Rinse PLUS		KVM1118A	DET&RINSE TANK LEFT GUIDE KIT FOR MM	<table border="1"> <thead> <tr> <th>Code</th> <th>Description</th> <th>Qty</th> <th>UOM</th> </tr> </thead> <tbody> <tr> <td>VI1220A1</td> <td>VITE AUTOFIL. 4.2X11 TCS+ MARUTEX</td> <td>2.000</td> <td>PZ</td> </tr> <tr> <td>VM1118A0</td> <td>GUIDA SX SERBATOIO DET&Rinse PLUS</td> <td>1.000</td> <td>PZ</td> </tr> </tbody> </table>	Code	Description	Qty	UOM	VI1220A1	VITE AUTOFIL. 4.2X11 TCS+ MARUTEX	2.000						PZ	VM1118A0	GUIDA SX SERBATOIO DET&Rinse PLUS	1.000	PZ																						
Code	Description	Qty	UOM																																														
VI1220A1	VITE AUTOFIL. 4.2X11 TCS+ MARUTEX	2.000	PZ																																														
VM1118A0	GUIDA SX SERBATOIO DET&Rinse PLUS	1.000	PZ																																														
VM1119A	GUIDA DX SERBATOIO DET&Rinse PLUS		KVM1119A	DET&RINSE TANK RIGHT GUIDE KIT FOR MM	<table border="1"> <thead> <tr> <th>Code</th> <th>Description</th> <th>Qty</th> <th>UOM</th> </tr> </thead> <tbody> <tr> <td>VI1220A1</td> <td>VITE AUTOFIL. 4.2X11 TCS+ MARUTEX</td> <td>2.000</td> <td>PZ</td> </tr> <tr> <td>VM1119A0</td> <td>GUIDA DX SERBATOIO DET&Rinse PLUS</td> <td>1.000</td> <td>PZ</td> </tr> </tbody> </table>	Code	Description	Qty	UOM	VI1220A1	VITE AUTOFIL. 4.2X11 TCS+ MARUTEX	2.000	PZ	VM1119A0	GUIDA DX SERBATOIO DET&Rinse PLUS	1.000	PZ																																
					VM1119A	GUIDA DX SERBATOIO DET&Rinse PLUS		KVM1119A	DET&RINSE TANK RIGHT GUIDE KIT FOR MM	<table border="1"> <thead> <tr> <th>Code</th> <th>Description</th> <th>Qty</th> <th>UOM</th> </tr> </thead> <tbody> <tr> <td>VI1220A1</td> <td>VITE AUTOFIL. 4.2X11 TCS+ MARUTEX</td> <td>2.000</td> <td>PZ</td> </tr> <tr> <td>VM1119A0</td> <td>GUIDA DX SERBATOIO DET&Rinse PLUS</td> <td>1.000</td> <td>PZ</td> </tr> </tbody> </table>	Code	Description	Qty	UOM	VI1220A1	VITE AUTOFIL. 4.2X11 TCS+ MARUTEX	2.000	PZ	VM1119A0	GUIDA DX SERBATOIO DET&Rinse PLUS	1.000	PZ																											
Code	Description	Qty	UOM																																														
VI1220A1	VITE AUTOFIL. 4.2X11 TCS+ MARUTEX	2.000	PZ																																														
VM1119A0	GUIDA DX SERBATOIO DET&Rinse PLUS	1.000	PZ																																														

COMPONENT			SPARE PART														
Code	Description	Image	Code	Description	Kit components												
RC1414A	FASCETTA STRINGITUBO A SCATTO D11.5-12.5		KRC1414A	D11-12 HOSE SNAP CLAMP 50 PCS KIT	<table border="1"> <thead> <tr> <th>Code</th> <th>Description</th> <th>Qty</th> <th>UOM</th> </tr> </thead> <tbody> <tr> <td>RC1414A1</td> <td>FASCETTA STRINGITUBO A SCATTO D11.5-12.5</td> <td>50.000</td> <td>PZ</td> </tr> </tbody> </table>	Code	Description	Qty	UOM	RC1414A1	FASCETTA STRINGITUBO A SCATTO D11.5-12.5	50.000	PZ				
					Code	Description	Qty	UOM									
RC1414A1	FASCETTA STRINGITUBO A SCATTO D11.5-12.5	50.000	PZ														
<table border="1"> <thead> <tr> <th>Code</th> <th>Description</th> <th>Qty</th> <th>UOM</th> </tr> </thead> <tbody> <tr> <td>TB3131A0</td> <td>TUBO TELATO EPDM BIANCO-NERO 6X12</td> <td>3.000</td> <td>M</td> </tr> <tr> <td>VM1794A0</td> <td>FASCETTA 430X4.8 PA66 NERA</td> <td>1.000</td> <td>PZ</td> </tr> </tbody> </table>	Code	Description	Qty	UOM	TB3131A0	TUBO TELATO EPDM BIANCO-NERO 6X12	3.000	M	VM1794A0	FASCETTA 430X4.8 PA66 NERA	1.000	PZ					
Code	Description	Qty	UOM														
TB3131A0	TUBO TELATO EPDM BIANCO-NERO 6X12	3.000	M														
VM1794A0	FASCETTA 430X4.8 PA66 NERA	1.000	PZ														
TB3251A	TB3131A-H2O STEAM INLET PIPE		KTB3131A	WHITE-BLACK 6X12 STEAM PIPE 3M KIT	<table border="1"> <thead> <tr> <th>Code</th> <th>Description</th> <th>Qty</th> <th>UOM</th> </tr> </thead> <tbody> <tr> <td>TB2243A0</td> <td>TUBO D10 PE TRASPARENT</td> <td>100.000</td> <td>M</td> </tr> <tr> <td>TB2243A0</td> <td>TUBO D10 PE TRASPARENT</td> <td>3.000</td> <td>M</td> </tr> </tbody> </table>	Code	Description	Qty	UOM	TB2243A0	TUBO D10 PE TRASPARENT	100.000	M	TB2243A0	TUBO D10 PE TRASPARENT	3.000	M
Code	Description	Qty	UOM														
TB2243A0	TUBO D10 PE TRASPARENT	100.000	M														
TB2243A0	TUBO D10 PE TRASPARENT	3.000	M														
TB1099A	TB3130A-D10 WATER CONNECTING PIPE		KTB2599A KTB2598A	Ø10 PET WATER PIPE TB2243A0 100M KIT D10 PET HUMIDITY PIPE TB2243A0 3 M KIT	<table border="1"> <thead> <tr> <th>Code</th> <th>Description</th> <th>Qty</th> <th>UOM</th> </tr> </thead> <tbody> <tr> <td>RC1360A0</td> <td>RACCORDO GOMITO JG 10-10</td> <td>1.000</td> <td>PZ</td> </tr> <tr> <td>VL1135A1</td> <td>RACCORDO 3/4-JG10 CON FILTRO E VNR</td> <td>1.000</td> <td>PZ</td> </tr> </tbody> </table>	Code	Description	Qty	UOM	RC1360A0	RACCORDO GOMITO JG 10-10	1.000	PZ	VL1135A1	RACCORDO 3/4-JG10 CON FILTRO E VNR	1.000	PZ
Code	Description	Qty	UOM														
RC1360A0	RACCORDO GOMITO JG 10-10	1.000	PZ														
VL1135A1	RACCORDO 3/4-JG10 CON FILTRO E VNR	1.000	PZ														
VL1135A	RACCORDO 3/4-JG10 CON FILTRO E VNR		KVL1135A	3/4-JG10 FITTING WITH FILTER AND VNR KIT	<table border="1"> <thead> <tr> <th>Code</th> <th>Description</th> <th>Qty</th> <th>UOM</th> </tr> </thead> <tbody> <tr> <td>OH8038A0</td> <td>LAMIERA SUPPORTO RIDUTTORE M</td> <td>1.000</td> <td>PZ</td> </tr> <tr> <td>V11220A1</td> <td>VITE AUTOFIL. 4.2X11 TCS+ MARUTEX</td> <td>4.000</td> <td>PZ</td> </tr> </tbody> </table>	Code	Description	Qty	UOM	OH8038A0	LAMIERA SUPPORTO RIDUTTORE M	1.000	PZ	V11220A1	VITE AUTOFIL. 4.2X11 TCS+ MARUTEX	4.000	PZ
Code	Description	Qty	UOM														
OH8038A0	LAMIERA SUPPORTO RIDUTTORE M	1.000	PZ														
V11220A1	VITE AUTOFIL. 4.2X11 TCS+ MARUTEX	4.000	PZ														
OH8038A	LAMIERA SUPPORTO RIDUTTORE MM		KOH8038A	MM REDUCER SUPPORT METAL SHEET	<table border="1"> <thead> <tr> <th>Code</th> <th>Description</th> <th>Qty</th> <th>UOM</th> </tr> </thead> <tbody> <tr> <td>OH8038A0</td> <td>LAMIERA SUPPORTO RIDUTTORE M</td> <td>1.000</td> <td>PZ</td> </tr> <tr> <td>V11220A1</td> <td>VITE AUTOFIL. 4.2X11 TCS+ MARUTEX</td> <td>4.000</td> <td>PZ</td> </tr> </tbody> </table>	Code	Description	Qty	UOM	OH8038A0	LAMIERA SUPPORTO RIDUTTORE M	1.000	PZ	V11220A1	VITE AUTOFIL. 4.2X11 TCS+ MARUTEX	4.000	PZ
Code	Description	Qty	UOM														
OH8038A0	LAMIERA SUPPORTO RIDUTTORE M	1.000	PZ														
V11220A1	VITE AUTOFIL. 4.2X11 TCS+ MARUTEX	4.000	PZ														

COMPONENT			SPARE PART					
Code	Description	Image	Code	Description	Kit components			
RC1243A	RACCORDO GOMITO CODOLO Ø10F-Ø10M		KVL1413A	EU SPEED-X HOOD WASHING KIT	Code	Description	Qty	UOM
					0H2514A1	LAMIERA SOSTEGNO EL1440	1.000	PZ
					0H5472A0	PORTA COMPONENTI CAPPA SPEED.X	1.000	PZ
					EL1440A0	ELETTROVALV OLA H2O AUTOPULENT E BAF EU	1.000	PZ
					GN1526A0	O-RING D.INT6.9 SP1.8	2.000	PZ
					RC1018A0	FASCETTA ELASTICA D12 ZINCATA	4.000	PZ
					RC1243A0	RACCORDO GOMITO CODOLO Ø10F-Ø10M	1.000	PZ
					RC1396A0	TERMINALE DRITTO JG D10-1/4	2.000	PZ
					TB3252A0	TB3132A-L=23 0MM EPDM BIANCO BLU	1.000	PZ
					TB3426A0	TB3132A-TUB O EPDM BIANCO BLU L90	1.000	PZ
					VI1220A1	VITE AUTOFIL. 4.2X11 TCS+ MARUTEX	2.000	PZ
					VL1014B3	RIDUTTORE DI PRESSIONE CON DISTRIBUTOR	1.000	PZ
					VL1095A0	RACCORDO DRITTO M-M PORTAGOMM A D7.8-D10	1.000	PZ
					VL1165A0	RACCORDO DRITTO BAM-BB6	2.000	PZ
					VM1054A0	GHIERA RIDUTTORE DI PRESSIONE H7.8	1.000	PZ
					VM1605A0	CLIP TWIST LOCK DIAM. 10,2-12,7 MM	1.000	PZ
					VM2652A0	SELLA DI CABLAGGIO	1.000	PZ

COMPONENT			SPARE PART																																																																			
Code	Description	Image	Code	Description	Kit components																																																																	
RC1243A	RACCORDO GOMITO CODOLO Ø10F-Ø10M		KVL1407A	CBX PRESS.REDUCER KIT 1.3 BAR	<table border="1"> <thead> <tr> <th>Code</th> <th>Description</th> <th>Qty</th> <th>UOM</th> </tr> </thead> <tbody> <tr> <td>RC1243A0</td> <td>RACCORDO GOMITO CODOLO Ø10F-Ø10M</td> <td>1.000</td> <td>PZ</td> </tr> <tr> <td>RC1396A0</td> <td>TERMINALE DRITTO JG D10-1/4</td> <td>2.000</td> <td>PZ</td> </tr> <tr> <td>VL1279A1</td> <td>RIDUTTORE DI PRESSIONE</td> <td>1.000</td> <td>PZ</td> </tr> </tbody> </table>	Code	Description	Qty	UOM	RC1243A0	RACCORDO GOMITO CODOLO Ø10F-Ø10M	1.000	PZ	RC1396A0	TERMINALE DRITTO JG D10-1/4	2.000	PZ	VL1279A1	RIDUTTORE DI PRESSIONE	1.000	PZ																																																	
			Code		Description	Qty	UOM																																																															
RC1243A0	RACCORDO GOMITO CODOLO Ø10F-Ø10M	1.000	PZ																																																																			
RC1396A0	TERMINALE DRITTO JG D10-1/4	2.000	PZ																																																																			
VL1279A1	RIDUTTORE DI PRESSIONE	1.000	PZ																																																																			
KVL1315A	CBX RECIRCULATION BOX KIT (NO PUMPS)	<table border="1"> <thead> <tr> <th>Code</th> <th>Description</th> <th>Qty</th> <th>UOM</th> </tr> </thead> <tbody> <tr> <td>0H6686A0</td> <td>SOSTEGNO STAFFA IDRICA DID</td> <td>1.000</td> <td>PZ</td> </tr> <tr> <td>GN1400A0</td> <td>GUARNIZIONE SIFONE</td> <td>1.000</td> <td>PZ</td> </tr> <tr> <td>RC1019A0</td> <td>FASCETTA ELASTICA D10 ZINCATA</td> <td>2.000</td> <td>PZ</td> </tr> <tr> <td>RC1360A0</td> <td>RACCORDO GOMITO JG 10-10</td> <td>2.000</td> <td>PZ</td> </tr> <tr> <td>RC1378A0</td> <td>FASCETTA STRINGI TUBO D25-40 ZINCAT</td> <td>1.000</td> <td>PZ</td> </tr> <tr> <td>RC1410A0</td> <td>FASCETTA STRINGITUBO D16-27 INOX</td> <td>2.000</td> <td>PZ</td> </tr> <tr> <td>SN1053A0</td> <td>SENSORE DI LIVELLO</td> <td>1.000</td> <td>PZ</td> </tr> <tr> <td>SN1061A0</td> <td>SONDA NTC D4x175MM</td> <td>1.000</td> <td>PZ</td> </tr> <tr> <td>TB3822A0</td> <td>TB3454A-TUB O L 40 MM</td> <td>1.000</td> <td>PZ</td> </tr> <tr> <td>TB4135A0</td> <td>TB2820A-TUB O EPDM NERO L140MM</td> <td>1.000</td> <td>PZ</td> </tr> <tr> <td>TB4160A0</td> <td>TB2243A-TUB O PE TRASP D10 L150MM</td> <td>1.000</td> <td>PZ</td> </tr> <tr> <td>VI1103A0</td> <td>VITE PER PLASTICA 4X12 TPBS+ ZN-NI</td> <td>6.000</td> <td>PZ</td> </tr> <tr> <td>VI1189A0</td> <td>RONDELLA M5 INOX A4 D10 SP1</td> <td>2.000</td> <td>PZ</td> </tr> <tr> <td>VI1220A1</td> <td>VITE AUTOFIL. 4.2X11 TCS+ MARUTEX</td> <td>2.000</td> <td>PZ</td> </tr> <tr> <td>VL1178A0</td> <td>O-RING D INT 10.8 CORDA 1.78 EPDM</td> <td>2.000</td> <td>PZ</td> </tr> <tr> <td>VL1315A1</td> <td>ASM BLOCCO VASCA POMPE DID</td> <td>1.000</td> <td>PZ</td> </tr> </tbody> </table>	Code	Description	Qty	UOM	0H6686A0	SOSTEGNO STAFFA IDRICA DID	1.000	PZ	GN1400A0	GUARNIZIONE SIFONE	1.000	PZ	RC1019A0	FASCETTA ELASTICA D10 ZINCATA	2.000	PZ	RC1360A0	RACCORDO GOMITO JG 10-10	2.000	PZ	RC1378A0	FASCETTA STRINGI TUBO D25-40 ZINCAT	1.000	PZ	RC1410A0	FASCETTA STRINGITUBO D16-27 INOX	2.000	PZ	SN1053A0	SENSORE DI LIVELLO	1.000	PZ	SN1061A0	SONDA NTC D4x175MM	1.000	PZ	TB3822A0	TB3454A-TUB O L 40 MM	1.000	PZ	TB4135A0	TB2820A-TUB O EPDM NERO L140MM	1.000	PZ	TB4160A0	TB2243A-TUB O PE TRASP D10 L150MM	1.000	PZ	VI1103A0	VITE PER PLASTICA 4X12 TPBS+ ZN-NI	6.000	PZ	VI1189A0	RONDELLA M5 INOX A4 D10 SP1	2.000	PZ	VI1220A1	VITE AUTOFIL. 4.2X11 TCS+ MARUTEX	2.000	PZ	VL1178A0	O-RING D INT 10.8 CORDA 1.78 EPDM	2.000	PZ	VL1315A1	ASM BLOCCO VASCA POMPE DID	1.000	PZ
Code		Description	Qty	UOM																																																																		
0H6686A0		SOSTEGNO STAFFA IDRICA DID	1.000	PZ																																																																		
GN1400A0		GUARNIZIONE SIFONE	1.000	PZ																																																																		
RC1019A0		FASCETTA ELASTICA D10 ZINCATA	2.000	PZ																																																																		
RC1360A0		RACCORDO GOMITO JG 10-10	2.000	PZ																																																																		
RC1378A0		FASCETTA STRINGI TUBO D25-40 ZINCAT	1.000	PZ																																																																		
RC1410A0		FASCETTA STRINGITUBO D16-27 INOX	2.000	PZ																																																																		
SN1053A0		SENSORE DI LIVELLO	1.000	PZ																																																																		
SN1061A0		SONDA NTC D4x175MM	1.000	PZ																																																																		
TB3822A0		TB3454A-TUB O L 40 MM	1.000	PZ																																																																		
TB4135A0		TB2820A-TUB O EPDM NERO L140MM	1.000	PZ																																																																		
TB4160A0		TB2243A-TUB O PE TRASP D10 L150MM	1.000	PZ																																																																		
VI1103A0		VITE PER PLASTICA 4X12 TPBS+ ZN-NI	6.000	PZ																																																																		
VI1189A0	RONDELLA M5 INOX A4 D10 SP1	2.000	PZ																																																																			
VI1220A1	VITE AUTOFIL. 4.2X11 TCS+ MARUTEX	2.000	PZ																																																																			
VL1178A0	O-RING D INT 10.8 CORDA 1.78 EPDM	2.000	PZ																																																																			
VL1315A1	ASM BLOCCO VASCA POMPE DID	1.000	PZ																																																																			

COMPONENT			SPARE PART																																															
Code	Description	Image	Code	Description	Kit components																																													
RC1243A	RACCORDO GOMITO CODOLO Ø10F-Ø10M		KVL1315A	CBX RECIRCULATION BOX KIT (NO PUMPS)	<table border="1"> <thead> <tr> <th>Code</th> <th>Description</th> <th>Qty</th> <th>UOM</th> </tr> </thead> <tbody> <tr> <td>VL1332A0</td> <td>TAPPO VASCA DID</td> <td>1.000</td> <td>PZ</td> </tr> <tr> <td>VL1340A0</td> <td>ATTACCO BYPASS M-M JG10 DID</td> <td>1.000</td> <td>PZ</td> </tr> <tr> <td>VL1400A0</td> <td>CURVA SCARICO BORDO PARZIALE</td> <td>1.000</td> <td>PZ</td> </tr> <tr> <td>VL1407A1</td> <td>ASM RIDUTTORE DI</td> <td>1.000</td> <td>PZ</td> </tr> <tr> <td>VM1802A0</td> <td>PERNO ROTAZIONE SPORTELLINO TANICHE DID</td> <td>1.000</td> <td>PZ</td> </tr> <tr> <td>VM2039A0</td> <td>ANELLO FISSAGGIO CURVA DI SCARICO</td> <td>1.000</td> <td>PZ</td> </tr> <tr> <td>VM2640A0</td> <td>PROTEZIONE POMPA SCARICO</td> <td>1.000</td> <td>PZ</td> </tr> </tbody> </table>	Code	Description	Qty	UOM	VL1332A0	TAPPO VASCA DID	1.000	PZ	VL1340A0	ATTACCO BYPASS M-M JG10 DID	1.000	PZ	VL1400A0	CURVA SCARICO BORDO PARZIALE	1.000	PZ	VL1407A1	ASM RIDUTTORE DI	1.000	PZ	VM1802A0	PERNO ROTAZIONE SPORTELLINO TANICHE DID	1.000	PZ	VM2039A0	ANELLO FISSAGGIO CURVA DI SCARICO	1.000	PZ	VM2640A0	PROTEZIONE POMPA SCARICO	1.000	PZ													
			Code	Description	Qty	UOM																																												
VL1332A0	TAPPO VASCA DID	1.000	PZ																																															
VL1340A0	ATTACCO BYPASS M-M JG10 DID	1.000	PZ																																															
VL1400A0	CURVA SCARICO BORDO PARZIALE	1.000	PZ																																															
VL1407A1	ASM RIDUTTORE DI	1.000	PZ																																															
VM1802A0	PERNO ROTAZIONE SPORTELLINO TANICHE DID	1.000	PZ																																															
VM2039A0	ANELLO FISSAGGIO CURVA DI SCARICO	1.000	PZ																																															
VM2640A0	PROTEZIONE POMPA SCARICO	1.000	PZ																																															
KVL1310A	COMPLETE CBX RECIRC TANK GROUP KIT	<table border="1"> <thead> <tr> <th>Code</th> <th>Description</th> <th>Qty</th> <th>UOM</th> </tr> </thead> <tbody> <tr> <td>0H5760A0</td> <td>COVER CONDENSATO RE CN1016</td> <td>1.000</td> <td>PZ</td> </tr> <tr> <td>0H6686A0</td> <td>SOSTEGNO STAFFA IDRICA DID</td> <td>1.000</td> <td>PZ</td> </tr> <tr> <td>CE2054A0</td> <td>CAVO RAST 5 POMPA DI SCARICO</td> <td>1.000</td> <td>PZ</td> </tr> <tr> <td>CE2055A0</td> <td>CAVO RAST 5 POMPA RICIRCOLO</td> <td>1.000</td> <td>PZ</td> </tr> <tr> <td>CN1016A0</td> <td>CONDENSATO RE 2.5 µF 500V CE/UL</td> <td>1.000</td> <td>PZ</td> </tr> <tr> <td>GN1400A0</td> <td>GUARNIZIONE SIFONE</td> <td>1.000</td> <td>PZ</td> </tr> <tr> <td>PM1013A0</td> <td>POMPA SCARICO 240V 32W</td> <td>1.000</td> <td>PZ</td> </tr> <tr> <td>PM1018A0</td> <td>POMPA RICIRCOLO 240V 100W</td> <td>1.000</td> <td>PZ</td> </tr> <tr> <td>RC1019A0</td> <td>FASCETTA ELASTICA D10 ZINCATA</td> <td>2.000</td> <td>PZ</td> </tr> <tr> <td>RC1046A0</td> <td>FASCETTA STRINGI TUBO D10-16 H9 INO</td> <td>1.000</td> <td>PZ</td> </tr> <tr> <td>RC1360A0</td> <td>RACCORDO GOMITO JG 10-10</td> <td>2.000</td> <td>PZ</td> </tr> </tbody> </table>	Code	Description	Qty	UOM	0H5760A0	COVER CONDENSATO RE CN1016	1.000	PZ	0H6686A0	SOSTEGNO STAFFA IDRICA DID	1.000	PZ	CE2054A0	CAVO RAST 5 POMPA DI SCARICO	1.000	PZ	CE2055A0	CAVO RAST 5 POMPA RICIRCOLO	1.000	PZ	CN1016A0	CONDENSATO RE 2.5 µF 500V CE/UL	1.000	PZ	GN1400A0	GUARNIZIONE SIFONE	1.000	PZ	PM1013A0	POMPA SCARICO 240V 32W	1.000	PZ	PM1018A0	POMPA RICIRCOLO 240V 100W	1.000	PZ	RC1019A0	FASCETTA ELASTICA D10 ZINCATA	2.000	PZ	RC1046A0	FASCETTA STRINGI TUBO D10-16 H9 INO	1.000	PZ	RC1360A0	RACCORDO GOMITO JG 10-10	2.000	PZ
Code	Description	Qty	UOM																																															
0H5760A0	COVER CONDENSATO RE CN1016	1.000	PZ																																															
0H6686A0	SOSTEGNO STAFFA IDRICA DID	1.000	PZ																																															
CE2054A0	CAVO RAST 5 POMPA DI SCARICO	1.000	PZ																																															
CE2055A0	CAVO RAST 5 POMPA RICIRCOLO	1.000	PZ																																															
CN1016A0	CONDENSATO RE 2.5 µF 500V CE/UL	1.000	PZ																																															
GN1400A0	GUARNIZIONE SIFONE	1.000	PZ																																															
PM1013A0	POMPA SCARICO 240V 32W	1.000	PZ																																															
PM1018A0	POMPA RICIRCOLO 240V 100W	1.000	PZ																																															
RC1019A0	FASCETTA ELASTICA D10 ZINCATA	2.000	PZ																																															
RC1046A0	FASCETTA STRINGI TUBO D10-16 H9 INO	1.000	PZ																																															
RC1360A0	RACCORDO GOMITO JG 10-10	2.000	PZ																																															

COMPONENT			SPARE PART																																																																																		
Code	Description	Image	Code	Description	Kit components																																																																																
RC1243A	RACCORDO GOMITO CODOLO Ø10F-Ø10M		KVL1310A	COMPLETE CBX RECIRC TANK GROUP KIT	<table border="1"> <thead> <tr> <th>Code</th> <th>Description</th> <th>Qty</th> <th>UOM</th> </tr> </thead> <tbody> <tr> <td>RC1378A0</td> <td>FASCETTA STRINGI TUBO D25-40 ZINCAT</td> <td>1.000</td> <td>PZ</td> </tr> <tr> <td>RC1410A0</td> <td>FASCETTA STRINGITUBO D16-27 INOX</td> <td>6.000</td> <td>PZ</td> </tr> <tr> <td>SN1053A0</td> <td>SENSORE DI LIVELLO</td> <td>1.000</td> <td>PZ</td> </tr> <tr> <td>SN1061A0</td> <td>SONDA NTC D4x175MM</td> <td>1.000</td> <td>PZ</td> </tr> <tr> <td>TB3822A0</td> <td>TB3454A-TUB O L 40 MM</td> <td>2.000</td> <td>PZ</td> </tr> <tr> <td>TB4135A0</td> <td>TB2820A-TUB O EPDM NERO L140MM</td> <td>1.000</td> <td>PZ</td> </tr> <tr> <td>TB4160A0</td> <td>TB2243A-TUB O PE TRASP D10 L150MM</td> <td>1.000</td> <td>PZ</td> </tr> <tr> <td>VI1103A0</td> <td>VITE PER PLASTICA 4X12 TPBS+ ZN-NI</td> <td>9.000</td> <td>PZ</td> </tr> <tr> <td>VI1220A1</td> <td>VITE AUTOFIL. 4.2X11 TCS+ MARUTEX</td> <td>2.000</td> <td>PZ</td> </tr> <tr> <td>VI1931A0</td> <td>DADO CONDENSATO RE M8x1.65 H4 CH13 ZINC</td> <td>1.000</td> <td>PZ</td> </tr> <tr> <td>VL1178A0</td> <td>O-RING D INT 10.8 CORDA 1.78 EPDM</td> <td>2.000</td> <td>PZ</td> </tr> <tr> <td>VL1315A1</td> <td>ASM BLOCCO VASCA POMPE DID</td> <td>1.000</td> <td>PZ</td> </tr> <tr> <td>VL1318A1</td> <td>SUPPORTO POMPA RICIRCOLO CBX</td> <td>1.000</td> <td>PZ</td> </tr> <tr> <td>VL1329A0</td> <td>RACCORDO D24-D16</td> <td>1.000</td> <td>PZ</td> </tr> <tr> <td>VL1332A0</td> <td>TAPPO VASCA DID</td> <td>1.000</td> <td>PZ</td> </tr> <tr> <td>VL1340A0</td> <td>ATTACCO BYPASS M-M JG10 DID</td> <td>1.000</td> <td>PZ</td> </tr> <tr> <td>VL1400A0</td> <td>CURVA SCARICO BORDO PARZIALE</td> <td>1.000</td> <td>PZ</td> </tr> <tr> <td>VL1407A1</td> <td>ASM RIDUTTORE DI</td> <td>1.000</td> <td>PZ</td> </tr> <tr> <td>VM1794A0</td> <td>FASCETTA 430X4.8 PA66 NERA</td> <td>1.000</td> <td>PZ</td> </tr> </tbody> </table>	Code	Description	Qty	UOM	RC1378A0	FASCETTA STRINGI TUBO D25-40 ZINCAT	1.000	PZ	RC1410A0	FASCETTA STRINGITUBO D16-27 INOX	6.000	PZ	SN1053A0	SENSORE DI LIVELLO	1.000	PZ	SN1061A0	SONDA NTC D4x175MM	1.000	PZ	TB3822A0	TB3454A-TUB O L 40 MM	2.000	PZ	TB4135A0	TB2820A-TUB O EPDM NERO L140MM	1.000	PZ	TB4160A0	TB2243A-TUB O PE TRASP D10 L150MM	1.000	PZ	VI1103A0	VITE PER PLASTICA 4X12 TPBS+ ZN-NI	9.000	PZ	VI1220A1	VITE AUTOFIL. 4.2X11 TCS+ MARUTEX	2.000	PZ	VI1931A0	DADO CONDENSATO RE M8x1.65 H4 CH13 ZINC	1.000	PZ	VL1178A0	O-RING D INT 10.8 CORDA 1.78 EPDM	2.000	PZ	VL1315A1	ASM BLOCCO VASCA POMPE DID	1.000	PZ	VL1318A1	SUPPORTO POMPA RICIRCOLO CBX	1.000	PZ	VL1329A0	RACCORDO D24-D16	1.000	PZ	VL1332A0	TAPPO VASCA DID	1.000	PZ	VL1340A0	ATTACCO BYPASS M-M JG10 DID	1.000	PZ	VL1400A0	CURVA SCARICO BORDO PARZIALE	1.000	PZ	VL1407A1	ASM RIDUTTORE DI	1.000	PZ	VM1794A0	FASCETTA 430X4.8 PA66 NERA	1.000	PZ
Code	Description	Qty	UOM																																																																																		
RC1378A0	FASCETTA STRINGI TUBO D25-40 ZINCAT	1.000	PZ																																																																																		
RC1410A0	FASCETTA STRINGITUBO D16-27 INOX	6.000	PZ																																																																																		
SN1053A0	SENSORE DI LIVELLO	1.000	PZ																																																																																		
SN1061A0	SONDA NTC D4x175MM	1.000	PZ																																																																																		
TB3822A0	TB3454A-TUB O L 40 MM	2.000	PZ																																																																																		
TB4135A0	TB2820A-TUB O EPDM NERO L140MM	1.000	PZ																																																																																		
TB4160A0	TB2243A-TUB O PE TRASP D10 L150MM	1.000	PZ																																																																																		
VI1103A0	VITE PER PLASTICA 4X12 TPBS+ ZN-NI	9.000	PZ																																																																																		
VI1220A1	VITE AUTOFIL. 4.2X11 TCS+ MARUTEX	2.000	PZ																																																																																		
VI1931A0	DADO CONDENSATO RE M8x1.65 H4 CH13 ZINC	1.000	PZ																																																																																		
VL1178A0	O-RING D INT 10.8 CORDA 1.78 EPDM	2.000	PZ																																																																																		
VL1315A1	ASM BLOCCO VASCA POMPE DID	1.000	PZ																																																																																		
VL1318A1	SUPPORTO POMPA RICIRCOLO CBX	1.000	PZ																																																																																		
VL1329A0	RACCORDO D24-D16	1.000	PZ																																																																																		
VL1332A0	TAPPO VASCA DID	1.000	PZ																																																																																		
VL1340A0	ATTACCO BYPASS M-M JG10 DID	1.000	PZ																																																																																		
VL1400A0	CURVA SCARICO BORDO PARZIALE	1.000	PZ																																																																																		
VL1407A1	ASM RIDUTTORE DI	1.000	PZ																																																																																		
VM1794A0	FASCETTA 430X4.8 PA66 NERA	1.000	PZ																																																																																		

COMPONENT			SPARE PART																																															
Code	Description	Image	Code	Description	Kit components																																													
RC1243A	RACCORDO GOMITO CODOLO Ø10F-Ø10M		KVL1310A	COMPLETE CBX RECIRC TANK GROUP KIT	<table border="1"> <thead> <tr> <th>Code</th> <th>Description</th> <th>Qty</th> <th>UOM</th> </tr> </thead> <tbody> <tr> <td>VM1802A0</td> <td>PERNO ROTAZIONE SPORTELLINO TANICHE DID</td> <td>1.000</td> <td>PZ</td> </tr> <tr> <td>VM2039A0</td> <td>ANELLO FISSAGGIO CURVA DI SCARICO</td> <td>1.000</td> <td>PZ</td> </tr> <tr> <td>VM2640A0</td> <td>PROTEZIONE POMPA SCARICO</td> <td>1.000</td> <td>PZ</td> </tr> </tbody> </table>	Code	Description	Qty	UOM	VM1802A0	PERNO ROTAZIONE SPORTELLINO TANICHE DID	1.000	PZ	VM2039A0	ANELLO FISSAGGIO CURVA DI SCARICO	1.000	PZ	VM2640A0	PROTEZIONE POMPA SCARICO	1.000	PZ																													
			Code	Description	Qty	UOM																																												
			VM1802A0	PERNO ROTAZIONE SPORTELLINO TANICHE DID	1.000	PZ																																												
VM2039A0	ANELLO FISSAGGIO CURVA DI SCARICO	1.000	PZ																																															
VM2640A0	PROTEZIONE POMPA SCARICO	1.000	PZ																																															
KVL1163A	MIND.Maps INLET CONNECTING PIPE KIT	<table border="1"> <thead> <tr> <th>Code</th> <th>Description</th> <th>Qty</th> <th>UOM</th> </tr> </thead> <tbody> <tr> <td>0H8038A0</td> <td>LAMIERA SUPPORTO RIDUTTORE M</td> <td>1.000</td> <td>PZ</td> </tr> <tr> <td>0H8039A0</td> <td>LAMIERA SUPPORTO RIDUTTORE COMPACT MM</td> <td>1.000</td> <td>PZ</td> </tr> <tr> <td>CH1026A0</td> <td>CHIAVE J.G. UNOX D8-D10</td> <td>1.000</td> <td>PZ</td> </tr> <tr> <td>RC1243A0</td> <td>RACCORDO GOMITO CODOLO Ø10F-Ø10M</td> <td>2.000</td> <td>PZ</td> </tr> <tr> <td>RC1396A0</td> <td>TERMINALE DRITTO JG D10-1/4</td> <td>2.000</td> <td>PZ</td> </tr> <tr> <td>TB2243A0</td> <td>TUBO D10 PE TRASPARENT</td> <td>0.050</td> <td>M</td> </tr> <tr> <td>VI1220A1</td> <td>VITE AUTOFIL. 4.2X11 TCS+ MARUTEX</td> <td>2.000</td> <td>PZ</td> </tr> <tr> <td>VI1950A0</td> <td>VITE AUTOFORANT E 4,2X13 TCB INOX</td> <td>1.000</td> <td>PZ</td> </tr> <tr> <td>VL1014B3</td> <td>RIDUTTORE DI PRESSIONE CON DISTRIBUTOR</td> <td>1.000</td> <td>PZ</td> </tr> <tr> <td>VL1135A1</td> <td>RACCORDO 3/4-JG10 CON FILTRO E VNR</td> <td>1.000</td> <td>PZ</td> </tr> <tr> <td>VM1054A0</td> <td>GHIERA RIDUTTORE DI PRESSIONE H7.8</td> <td>1.000</td> <td>PZ</td> </tr> </tbody> </table>	Code	Description	Qty	UOM	0H8038A0	LAMIERA SUPPORTO RIDUTTORE M	1.000	PZ	0H8039A0	LAMIERA SUPPORTO RIDUTTORE COMPACT MM	1.000	PZ	CH1026A0	CHIAVE J.G. UNOX D8-D10	1.000	PZ	RC1243A0	RACCORDO GOMITO CODOLO Ø10F-Ø10M	2.000	PZ	RC1396A0	TERMINALE DRITTO JG D10-1/4	2.000	PZ	TB2243A0	TUBO D10 PE TRASPARENT	0.050	M	VI1220A1	VITE AUTOFIL. 4.2X11 TCS+ MARUTEX	2.000	PZ	VI1950A0	VITE AUTOFORANT E 4,2X13 TCB INOX	1.000	PZ	VL1014B3	RIDUTTORE DI PRESSIONE CON DISTRIBUTOR	1.000	PZ	VL1135A1	RACCORDO 3/4-JG10 CON FILTRO E VNR	1.000	PZ	VM1054A0	GHIERA RIDUTTORE DI PRESSIONE H7.8	1.000	PZ
Code	Description	Qty	UOM																																															
0H8038A0	LAMIERA SUPPORTO RIDUTTORE M	1.000	PZ																																															
0H8039A0	LAMIERA SUPPORTO RIDUTTORE COMPACT MM	1.000	PZ																																															
CH1026A0	CHIAVE J.G. UNOX D8-D10	1.000	PZ																																															
RC1243A0	RACCORDO GOMITO CODOLO Ø10F-Ø10M	2.000	PZ																																															
RC1396A0	TERMINALE DRITTO JG D10-1/4	2.000	PZ																																															
TB2243A0	TUBO D10 PE TRASPARENT	0.050	M																																															
VI1220A1	VITE AUTOFIL. 4.2X11 TCS+ MARUTEX	2.000	PZ																																															
VI1950A0	VITE AUTOFORANT E 4,2X13 TCB INOX	1.000	PZ																																															
VL1014B3	RIDUTTORE DI PRESSIONE CON DISTRIBUTOR	1.000	PZ																																															
VL1135A1	RACCORDO 3/4-JG10 CON FILTRO E VNR	1.000	PZ																																															
VM1054A0	GHIERA RIDUTTORE DI PRESSIONE H7.8	1.000	PZ																																															
KRC1243A	Ø10F-Ø10M ELBOW CONN + JG END 10 PCS KIT	<table border="1"> <thead> <tr> <th>Code</th> <th>Description</th> <th>Qty</th> <th>UOM</th> </tr> </thead> <tbody> <tr> <td>RC1243A0</td> <td>RACCORDO GOMITO CODOLO Ø10F-Ø10M</td> <td>10.000</td> <td>PZ</td> </tr> </tbody> </table>	Code	Description	Qty	UOM	RC1243A0	RACCORDO GOMITO CODOLO Ø10F-Ø10M	10.000	PZ																																								
Code	Description	Qty	UOM																																															
RC1243A0	RACCORDO GOMITO CODOLO Ø10F-Ø10M	10.000	PZ																																															

COMPONENT			SPARE PART																																																																										
Code	Description	Image	Code	Description	Kit components																																																																								
RC1396A	TERMINALE DRITTO JG D10-1/4		KVL1465A	CB -X GN2/1 HOOD HYDRIC CIRCUIT KI	<table border="1"> <thead> <tr> <th>Code</th> <th>Description</th> <th>Qty</th> <th>UOM</th> </tr> </thead> <tbody> <tr> <td>0H8067A0</td> <td>LAMIERA SOSTEGNO EL CAPP A CBX</td> <td>1.000</td> <td>PZ</td> </tr> <tr> <td>EL1440A0</td> <td>ELETTROVALV OLA H2O AUTOPULENT E BAF EU</td> <td>2.000</td> <td>PZ</td> </tr> <tr> <td>GN1526A0</td> <td>O-RING D.INT6,9 SP1.8</td> <td>4.000</td> <td>PZ</td> </tr> <tr> <td>RC1018A0</td> <td>FASCETTA ELASTICA D12 ZINCATA</td> <td>12.000</td> <td>PZ</td> </tr> <tr> <td>RC1121A0</td> <td>RACCORDO Y D10-D10-10</td> <td>2.000</td> <td>PZ</td> </tr> <tr> <td>RC1243A0</td> <td>RACCORDO GOMITO CODOLO Ø10F-Ø10M</td> <td>1.000</td> <td>PZ</td> </tr> <tr> <td>RC1396A0</td> <td>TERMINALE DRITTO JG D10-1/4</td> <td>2.000</td> <td>PZ</td> </tr> <tr> <td>RC1414A1</td> <td>FASCETTA STRINGITUBO A SCATTO D11.5-12.5</td> <td>4.000</td> <td>PZ</td> </tr> <tr> <td>TB2867A0</td> <td>TB3132A-TUB O L75 MM</td> <td>8.000</td> <td>PZ</td> </tr> <tr> <td>VL1014B3</td> <td>RIDUTTORE DI PRESSIONE CON DISTRIBUTOR</td> <td>1.000</td> <td>PZ</td> </tr> <tr> <td>VL1095A0</td> <td>RACCORDO DRITTO M-M PORTAGOMM A D7.8-D10</td> <td>6.000</td> <td>PZ</td> </tr> <tr> <td>VL1165A0</td> <td>RACCORDO DRITTO BAM-BB6</td> <td>2.000</td> <td>PZ</td> </tr> <tr> <td>VL1166A0</td> <td>RACCORDO A L BAM-BB6</td> <td>2.000</td> <td>PZ</td> </tr> <tr> <td>VL1437A0</td> <td>DISTRIBUTOR E INGRESSI LAVAGGIO CAPP A CBX</td> <td>1.000</td> <td>PZ</td> </tr> <tr> <td>VM1054A0</td> <td>GHIERA RIDUTTORE DI PRESSIONE H7.8</td> <td>1.000</td> <td>PZ</td> </tr> <tr> <td>VM1605A0</td> <td>CLIP TWIST LOCK DIAM. 10,2-12,7 MM</td> <td>2.000</td> <td>PZ</td> </tr> <tr> <td>VM2652A0</td> <td>SELLA DI CABLAGGIO</td> <td>1.000</td> <td>PZ</td> </tr> </tbody> </table>	Code	Description	Qty	UOM	0H8067A0	LAMIERA SOSTEGNO EL CAPP A CBX	1.000	PZ	EL1440A0	ELETTROVALV OLA H2O AUTOPULENT E BAF EU	2.000	PZ	GN1526A0	O-RING D.INT6,9 SP1.8	4.000	PZ	RC1018A0	FASCETTA ELASTICA D12 ZINCATA	12.000	PZ	RC1121A0	RACCORDO Y D10-D10-10	2.000	PZ	RC1243A0	RACCORDO GOMITO CODOLO Ø10F-Ø10M	1.000	PZ	RC1396A0	TERMINALE DRITTO JG D10-1/4	2.000	PZ	RC1414A1	FASCETTA STRINGITUBO A SCATTO D11.5-12.5	4.000	PZ	TB2867A0	TB3132A-TUB O L75 MM	8.000	PZ	VL1014B3	RIDUTTORE DI PRESSIONE CON DISTRIBUTOR	1.000	PZ	VL1095A0	RACCORDO DRITTO M-M PORTAGOMM A D7.8-D10	6.000	PZ	VL1165A0	RACCORDO DRITTO BAM-BB6	2.000	PZ	VL1166A0	RACCORDO A L BAM-BB6	2.000	PZ	VL1437A0	DISTRIBUTOR E INGRESSI LAVAGGIO CAPP A CBX	1.000	PZ	VM1054A0	GHIERA RIDUTTORE DI PRESSIONE H7.8	1.000	PZ	VM1605A0	CLIP TWIST LOCK DIAM. 10,2-12,7 MM	2.000	PZ	VM2652A0	SELLA DI CABLAGGIO	1.000	PZ
					Code	Description	Qty	UOM																																																																					
					0H8067A0	LAMIERA SOSTEGNO EL CAPP A CBX	1.000	PZ																																																																					
					EL1440A0	ELETTROVALV OLA H2O AUTOPULENT E BAF EU	2.000	PZ																																																																					
					GN1526A0	O-RING D.INT6,9 SP1.8	4.000	PZ																																																																					
					RC1018A0	FASCETTA ELASTICA D12 ZINCATA	12.000	PZ																																																																					
					RC1121A0	RACCORDO Y D10-D10-10	2.000	PZ																																																																					
					RC1243A0	RACCORDO GOMITO CODOLO Ø10F-Ø10M	1.000	PZ																																																																					
					RC1396A0	TERMINALE DRITTO JG D10-1/4	2.000	PZ																																																																					
					RC1414A1	FASCETTA STRINGITUBO A SCATTO D11.5-12.5	4.000	PZ																																																																					
					TB2867A0	TB3132A-TUB O L75 MM	8.000	PZ																																																																					
					VL1014B3	RIDUTTORE DI PRESSIONE CON DISTRIBUTOR	1.000	PZ																																																																					
					VL1095A0	RACCORDO DRITTO M-M PORTAGOMM A D7.8-D10	6.000	PZ																																																																					
					VL1165A0	RACCORDO DRITTO BAM-BB6	2.000	PZ																																																																					
					VL1166A0	RACCORDO A L BAM-BB6	2.000	PZ																																																																					
					VL1437A0	DISTRIBUTOR E INGRESSI LAVAGGIO CAPP A CBX	1.000	PZ																																																																					
					VM1054A0	GHIERA RIDUTTORE DI PRESSIONE H7.8	1.000	PZ																																																																					
VM1605A0	CLIP TWIST LOCK DIAM. 10,2-12,7 MM	2.000	PZ																																																																										
VM2652A0	SELLA DI CABLAGGIO	1.000	PZ																																																																										

COMPONENT			SPARE PART					
Code	Description	Image	Code	Description	Kit components			
RC1396A	TERMINALE DRITTO JG D10-1/4		KVL1464A	BAKERTOP-X HOOD HYDRIC CIRCUIT KI	Code	Description	Qty	UOM
					0H8067A0	LAMIERA SOSTEGNO EL CAPP A CBX	1.000	PZ
					EL1440A0	ELETTROVALV OLA H2O AUTOPULENT E BAF EU	2.000	PZ
					GN1526A0	O-RING D.INT6,9 SP1.8	4.000	PZ
					RC1018A0	FASCETTA ELASTICA D12 ZINCATA	4.000	PZ
					RC1243A0	RACCORDO GOMITO CODOLO Ø10F-Ø10M	1.000	PZ
					RC1396A0	TERMINALE DRITTO JG D10-1/4	2.000	PZ
					RC1414A1	FASCETTA STRINGITUBO A SCATTO D11.5-12.5	4.000	PZ
					TB2867A0	TB3132A-TUB O L75 MM	2.000	PZ
					TB3246A0	TB3132A-TUB O EPDM TELATO BIANCO-BLU 220M	2.000	PZ
					VL1014B3	RIDUTTORE DI PRESSIONE CON DISTRIBUTOR	1.000	PZ
					VL1165A0	RACCORDO DRITTO BAM-BB6	2.000	PZ
					VL1166A0	RACCORDO A L BAM-BB6	2.000	PZ
					VL1437A0	DISTRIBUTOR E INGRESSI LAVAGGIO CAPP A CBX	1.000	PZ
					VM1054A0	GHIERA RIDUTTORE DI PRESSIONE H7.8	1.000	PZ
					VM1605A0	CLIP TWIST LOCK DIAM. 10,2-12,7 MM	2.000	PZ
					VM2652A0	SELLA DI CABLAGGIO	1.000	PZ

COMPONENT			SPARE PART					
Code	Description	Image	Code	Description	Kit components			
RC1396A	TERMINALE DRITTO JG D10-1/4		KVL1458A	CB -X HOOD HYDRIC SYSTEM KI	Code	Description	Qty	UOM
					0H8067A0	LAMIERA SOSTEGNO EL CAPP A CBX	1.000	PZ
					EL1440A0	ELETTROVALV OLA H2O AUTOPULENT E BAF EU	2.000	PZ
					GN1526A0	O-RING D.INT6,9 SP1.8	4.000	PZ
					RC1018A0	FASCETTA ELASTICA D12 ZINCATA	4.000	PZ
					RC1243A0	RACCORDO GOMITO CODOLO Ø10F-Ø10M	1.000	PZ
					RC1396A0	TERMINALE DRITTO JG D10-1/4	2.000	PZ
					RC1414A1	FASCETTA STRINGITUBO A SCATTO D11.5-12.5	4.000	PZ
					TB1663A0	TB3132-TUBO EPDM CONDENSATO RE SP 150MM	2.000	PZ
					TB2867A0	TB3132A-TUB O L75 MM	2.000	PZ
					VL1014B3	RIDUTTORE DI PRESSIONE CON DISTRIBUTOR	1.000	PZ
					VL1165A0	RACCORDO DRITTO BAM-BB6	2.000	PZ
					VL1166A0	RACCORDO A L BAM-BB6	2.000	PZ
					VL1437A0	DISTRIBUTOR E INGRESSI LAVAGGIO CAPP A CBX	1.000	PZ
					VM1054A0	GHIERA RIDUTTORE DI PRESSIONE H7.8	1.000	PZ
					VM1605A0	CLIP TWIST LOCK DIAM. 10,2-12,7 MM	2.000	PZ
					VM2652A0	SELLA DI CABLAGGIO	1.000	PZ

COMPONENT			SPARE PART																																																																																		
Code	Description	Image	Code	Description	Kit components																																																																																
RC1396A	TERMINALE DRITTO JG D10-1/4		KVL1425A	CBX COMPLETE TANK REPLACEMENT KIT	<table border="1"> <thead> <tr> <th>Code</th> <th>Description</th> <th>Qty</th> <th>UOM</th> </tr> </thead> <tbody> <tr> <td>0H5760A0</td> <td>COVER CONDENSATO RE CN1016</td> <td>1.000</td> <td>PZ</td> </tr> <tr> <td>0H6686A0</td> <td>SOSTEGNO STAFFA IDRICA DID</td> <td>1.000</td> <td>PZ</td> </tr> <tr> <td>CN1016A0</td> <td>CONDENSATO RE 2.5 uF 500V CE/UL</td> <td>1.000</td> <td>PZ</td> </tr> <tr> <td>GN1400A0</td> <td>GUARNIZIONE SIFONE</td> <td>1.000</td> <td>PZ</td> </tr> <tr> <td>PM1013A0</td> <td>POMPA SCARICO 240V 32W</td> <td>1.000</td> <td>PZ</td> </tr> <tr> <td>PM1018A0</td> <td>POMPA RICIRCOLO 240V 100W</td> <td>1.000</td> <td>PZ</td> </tr> <tr> <td>RC1019A0</td> <td>FASCETTA ELASTICA D10 ZINCATA</td> <td>2.000</td> <td>PZ</td> </tr> <tr> <td>RC1046A0</td> <td>FASCETTA STRINGI TUBO D10-16 H9 INO</td> <td>1.000</td> <td>PZ</td> </tr> <tr> <td>RC1360A0</td> <td>RACCORDO GOMITO JG 10-10</td> <td>2.000</td> <td>PZ</td> </tr> <tr> <td>RC1378A0</td> <td>FASCETTA STRINGI TUBO D25-40 ZINCAT</td> <td>1.000</td> <td>PZ</td> </tr> <tr> <td>RC1410A0</td> <td>FASCETTA STRINGITUBO D16-27 INOX</td> <td>6.000</td> <td>PZ</td> </tr> <tr> <td>SN1053A0</td> <td>SENSORE DI LIVELLO</td> <td>1.000</td> <td>PZ</td> </tr> <tr> <td>SN1061A0</td> <td>SONDA NTC D4x175MM</td> <td>1.000</td> <td>PZ</td> </tr> <tr> <td>TB3822A0</td> <td>TB3454A-TUB O L 40 MM</td> <td>2.000</td> <td>PZ</td> </tr> <tr> <td>TB4135A0</td> <td>TB2820A-TUB O EPDM NERO L140MM</td> <td>1.000</td> <td>PZ</td> </tr> <tr> <td>TB4160A0</td> <td>TB2243A-TUB O PE TRASP D10 L150MM</td> <td>1.000</td> <td>PZ</td> </tr> <tr> <td>VI1103A0</td> <td>VITE PER PLASTICA 4X12 TPBS+ ZN-NI</td> <td>9.000</td> <td>PZ</td> </tr> <tr> <td>VI1220A1</td> <td>VITE AUTOFIL. 4.2X11 TCS+ MARUTEX</td> <td>2.000</td> <td>PZ</td> </tr> <tr> <td>VI1931A0</td> <td>DADO CONDENSATO RE M8x1.65 H4 CH13 ZINC</td> <td>1.000</td> <td>PZ</td> </tr> </tbody> </table>	Code	Description	Qty	UOM	0H5760A0	COVER CONDENSATO RE CN1016	1.000	PZ	0H6686A0	SOSTEGNO STAFFA IDRICA DID	1.000	PZ	CN1016A0	CONDENSATO RE 2.5 uF 500V CE/UL	1.000	PZ	GN1400A0	GUARNIZIONE SIFONE	1.000	PZ	PM1013A0	POMPA SCARICO 240V 32W	1.000	PZ	PM1018A0	POMPA RICIRCOLO 240V 100W	1.000	PZ	RC1019A0	FASCETTA ELASTICA D10 ZINCATA	2.000	PZ	RC1046A0	FASCETTA STRINGI TUBO D10-16 H9 INO	1.000	PZ	RC1360A0	RACCORDO GOMITO JG 10-10	2.000	PZ	RC1378A0	FASCETTA STRINGI TUBO D25-40 ZINCAT	1.000	PZ	RC1410A0	FASCETTA STRINGITUBO D16-27 INOX	6.000	PZ	SN1053A0	SENSORE DI LIVELLO	1.000	PZ	SN1061A0	SONDA NTC D4x175MM	1.000	PZ	TB3822A0	TB3454A-TUB O L 40 MM	2.000	PZ	TB4135A0	TB2820A-TUB O EPDM NERO L140MM	1.000	PZ	TB4160A0	TB2243A-TUB O PE TRASP D10 L150MM	1.000	PZ	VI1103A0	VITE PER PLASTICA 4X12 TPBS+ ZN-NI	9.000	PZ	VI1220A1	VITE AUTOFIL. 4.2X11 TCS+ MARUTEX	2.000	PZ	VI1931A0	DADO CONDENSATO RE M8x1.65 H4 CH13 ZINC	1.000	PZ
Code	Description	Qty	UOM																																																																																		
0H5760A0	COVER CONDENSATO RE CN1016	1.000	PZ																																																																																		
0H6686A0	SOSTEGNO STAFFA IDRICA DID	1.000	PZ																																																																																		
CN1016A0	CONDENSATO RE 2.5 uF 500V CE/UL	1.000	PZ																																																																																		
GN1400A0	GUARNIZIONE SIFONE	1.000	PZ																																																																																		
PM1013A0	POMPA SCARICO 240V 32W	1.000	PZ																																																																																		
PM1018A0	POMPA RICIRCOLO 240V 100W	1.000	PZ																																																																																		
RC1019A0	FASCETTA ELASTICA D10 ZINCATA	2.000	PZ																																																																																		
RC1046A0	FASCETTA STRINGI TUBO D10-16 H9 INO	1.000	PZ																																																																																		
RC1360A0	RACCORDO GOMITO JG 10-10	2.000	PZ																																																																																		
RC1378A0	FASCETTA STRINGI TUBO D25-40 ZINCAT	1.000	PZ																																																																																		
RC1410A0	FASCETTA STRINGITUBO D16-27 INOX	6.000	PZ																																																																																		
SN1053A0	SENSORE DI LIVELLO	1.000	PZ																																																																																		
SN1061A0	SONDA NTC D4x175MM	1.000	PZ																																																																																		
TB3822A0	TB3454A-TUB O L 40 MM	2.000	PZ																																																																																		
TB4135A0	TB2820A-TUB O EPDM NERO L140MM	1.000	PZ																																																																																		
TB4160A0	TB2243A-TUB O PE TRASP D10 L150MM	1.000	PZ																																																																																		
VI1103A0	VITE PER PLASTICA 4X12 TPBS+ ZN-NI	9.000	PZ																																																																																		
VI1220A1	VITE AUTOFIL. 4.2X11 TCS+ MARUTEX	2.000	PZ																																																																																		
VI1931A0	DADO CONDENSATO RE M8x1.65 H4 CH13 ZINC	1.000	PZ																																																																																		

COMPONENT			SPARE PART																																																																													
Code	Description	Image	Code	Description	Kit components																																																																											
RC1396A	TERMINALE DRITTO JG D10-1/4		KVL1425A	CBX COMPLETE TANK REPLACEMENT KIT	<table border="1"> <thead> <tr> <th>Code</th> <th>Description</th> <th>Qty</th> <th>UOM</th> </tr> </thead> <tbody> <tr> <td>VL1178A0</td> <td>O-RING D INT 10.8 CORDA 1.78 EPDM</td> <td>2.000</td> <td>PZ</td> </tr> <tr> <td>VL1318A1</td> <td>SUPPORTO POMPA RICIRCOLO CBX</td> <td>1.000</td> <td>PZ</td> </tr> <tr> <td>VL1329A0</td> <td>RACCORDO D24-D16</td> <td>1.000</td> <td>PZ</td> </tr> <tr> <td>VL1332A0</td> <td>TAPPO VASCA DID</td> <td>1.000</td> <td>PZ</td> </tr> <tr> <td>VL1340A0</td> <td>ATTACCO BYPASS M-M JG10 DID</td> <td>1.000</td> <td>PZ</td> </tr> <tr> <td>VL1400A0</td> <td>CURVA SCARICO BORDO PARZIALE</td> <td>1.000</td> <td>PZ</td> </tr> <tr> <td>VL1407A1</td> <td>ASM RIDUTTORE DI</td> <td>1.000</td> <td>PZ</td> </tr> <tr> <td>VL1425A0</td> <td>ASM BLOCCO VASCA POMPE CBX USA</td> <td>1.000</td> <td>PZ</td> </tr> <tr> <td>VM1794A0</td> <td>FASCETTA 430X4.8 PA66 NERA</td> <td>1.000</td> <td>PZ</td> </tr> <tr> <td>VM1802A0</td> <td>PERNO ROTAZIONE SPORTELLINO TANICHE DID</td> <td>1.000</td> <td>PZ</td> </tr> <tr> <td>VM2039A0</td> <td>ANELLO FISSAGGIO CURVA DI SCARICO</td> <td>1.000</td> <td>PZ</td> </tr> <tr> <td>VM2640A0</td> <td>PROTEZIONE POMPA SCARICO</td> <td>1.000</td> <td>PZ</td> </tr> </tbody> </table>	Code	Description	Qty	UOM	VL1178A0	O-RING D INT 10.8 CORDA 1.78 EPDM	2.000	PZ	VL1318A1	SUPPORTO POMPA RICIRCOLO CBX	1.000	PZ	VL1329A0	RACCORDO D24-D16	1.000	PZ	VL1332A0	TAPPO VASCA DID	1.000	PZ	VL1340A0	ATTACCO BYPASS M-M JG10 DID	1.000	PZ	VL1400A0	CURVA SCARICO BORDO PARZIALE	1.000	PZ	VL1407A1	ASM RIDUTTORE DI	1.000	PZ	VL1425A0	ASM BLOCCO VASCA POMPE CBX USA	1.000	PZ	VM1794A0	FASCETTA 430X4.8 PA66 NERA	1.000	PZ	VM1802A0	PERNO ROTAZIONE SPORTELLINO TANICHE DID	1.000	PZ	VM2039A0	ANELLO FISSAGGIO CURVA DI SCARICO	1.000	PZ	VM2640A0	PROTEZIONE POMPA SCARICO	1.000	PZ	KVL1413A	EU SPEED-X HOOD WASHING KIT	<table border="1"> <thead> <tr> <th>Code</th> <th>Description</th> <th>Qty</th> <th>UOM</th> </tr> </thead> <tbody> <tr> <td>0H2514A1</td> <td>LAMIERA SOSTEGNO EL1440</td> <td>1.000</td> <td>PZ</td> </tr> <tr> <td>0H5472A0</td> <td>PORTA COMPONENTI CAPP SPEED X</td> <td>1.000</td> <td>PZ</td> </tr> <tr> <td>EL1440A0</td> <td>ELETTROVALV OLA H2O AUTOPULENT E BAF EU</td> <td>1.000</td> <td>PZ</td> </tr> <tr> <td>GN1526A0</td> <td>O-RING D.INT6.9 SP1.8</td> <td>2.000</td> <td>PZ</td> </tr> </tbody> </table>	Code	Description	Qty	UOM	0H2514A1	LAMIERA SOSTEGNO EL1440	1.000	PZ	0H5472A0	PORTA COMPONENTI CAPP SPEED X	1.000	PZ	EL1440A0	ELETTROVALV OLA H2O AUTOPULENT E BAF EU	1.000	PZ	GN1526A0	O-RING D.INT6.9 SP1.8	2.000	PZ
			Code		Description	Qty	UOM																																																																									
VL1178A0	O-RING D INT 10.8 CORDA 1.78 EPDM	2.000	PZ																																																																													
VL1318A1	SUPPORTO POMPA RICIRCOLO CBX	1.000	PZ																																																																													
VL1329A0	RACCORDO D24-D16	1.000	PZ																																																																													
VL1332A0	TAPPO VASCA DID	1.000	PZ																																																																													
VL1340A0	ATTACCO BYPASS M-M JG10 DID	1.000	PZ																																																																													
VL1400A0	CURVA SCARICO BORDO PARZIALE	1.000	PZ																																																																													
VL1407A1	ASM RIDUTTORE DI	1.000	PZ																																																																													
VL1425A0	ASM BLOCCO VASCA POMPE CBX USA	1.000	PZ																																																																													
VM1794A0	FASCETTA 430X4.8 PA66 NERA	1.000	PZ																																																																													
VM1802A0	PERNO ROTAZIONE SPORTELLINO TANICHE DID	1.000	PZ																																																																													
VM2039A0	ANELLO FISSAGGIO CURVA DI SCARICO	1.000	PZ																																																																													
VM2640A0	PROTEZIONE POMPA SCARICO	1.000	PZ																																																																													
Code	Description	Qty	UOM																																																																													
0H2514A1	LAMIERA SOSTEGNO EL1440	1.000	PZ																																																																													
0H5472A0	PORTA COMPONENTI CAPP SPEED X	1.000	PZ																																																																													
EL1440A0	ELETTROVALV OLA H2O AUTOPULENT E BAF EU	1.000	PZ																																																																													
GN1526A0	O-RING D.INT6.9 SP1.8	2.000	PZ																																																																													

COMPONENT			SPARE PART																																																																									
Code	Description	Image	Code	Description	Kit components																																																																							
RC1396A	TERMINALE DRITTO JG D10-1/4		KVL1413A	EU SPEED-X HOOD WASHING KIT	<table border="1"> <thead> <tr> <th>Code</th> <th>Description</th> <th>Qty</th> <th>UOM</th> </tr> </thead> <tbody> <tr> <td>RC1018A0</td> <td>FASCETTA ELASTICA D12 ZINCATA</td> <td>4.000</td> <td>PZ</td> </tr> <tr> <td>RC1243A0</td> <td>RACCORDO GOMITO CODOLO Ø10F-Ø10M</td> <td>1.000</td> <td>PZ</td> </tr> <tr> <td>RC1396A0</td> <td>TERMINALE DRITTO JG D10-1/4</td> <td>2.000</td> <td>PZ</td> </tr> <tr> <td>TB3252A0</td> <td>TB3132A-L=23 0MM EPDM BIANCO BLU</td> <td>1.000</td> <td>PZ</td> </tr> <tr> <td>TB3426A0</td> <td>TB3132A-TUB O EPDM BIANCO BLU L90</td> <td>1.000</td> <td>PZ</td> </tr> <tr> <td>VI1220A1</td> <td>VITE AUTOFIL. 4.2X11 TCS+ MARUTEX</td> <td>2.000</td> <td>PZ</td> </tr> <tr> <td>VL1014B3</td> <td>RIDUTTORE DI PRESSIONE CON DISTRIBUTOR</td> <td>1.000</td> <td>PZ</td> </tr> <tr> <td>VL1095A0</td> <td>RACCORDO DRITTO M-M PORTAGOMM A D7.8-D10</td> <td>1.000</td> <td>PZ</td> </tr> <tr> <td>VL1165A0</td> <td>RACCORDO DRITTO BAM-BB6</td> <td>2.000</td> <td>PZ</td> </tr> <tr> <td>VM1054A0</td> <td>GHIERA RIDUTTORE DI PRESSIONE H7.8</td> <td>1.000</td> <td>PZ</td> </tr> <tr> <td>VM1605A0</td> <td>CLIP TWIST LOCK DIAM. 10,2-12,7 MM</td> <td>1.000</td> <td>PZ</td> </tr> <tr> <td>VM2652A0</td> <td>SELLA DI CABLAGGIO</td> <td>1.000</td> <td>PZ</td> </tr> </tbody> </table>	Code	Description	Qty	UOM	RC1018A0	FASCETTA ELASTICA D12 ZINCATA	4.000	PZ	RC1243A0	RACCORDO GOMITO CODOLO Ø10F-Ø10M	1.000	PZ	RC1396A0	TERMINALE DRITTO JG D10-1/4	2.000	PZ	TB3252A0	TB3132A-L=23 0MM EPDM BIANCO BLU	1.000	PZ	TB3426A0	TB3132A-TUB O EPDM BIANCO BLU L90	1.000	PZ	VI1220A1	VITE AUTOFIL. 4.2X11 TCS+ MARUTEX	2.000	PZ	VL1014B3	RIDUTTORE DI PRESSIONE CON DISTRIBUTOR	1.000	PZ	VL1095A0	RACCORDO DRITTO M-M PORTAGOMM A D7.8-D10	1.000	PZ	VL1165A0	RACCORDO DRITTO BAM-BB6	2.000	PZ	VM1054A0	GHIERA RIDUTTORE DI PRESSIONE H7.8	1.000	PZ	VM1605A0	CLIP TWIST LOCK DIAM. 10,2-12,7 MM	1.000	PZ	VM2652A0	SELLA DI CABLAGGIO	1.000	PZ	KVL1407A	CBX PRESS.REDUCER KIT 1.3 BAR	<table border="1"> <thead> <tr> <th>Code</th> <th>Description</th> <th>Qty</th> <th>UOM</th> </tr> </thead> <tbody> <tr> <td>RC1243A0</td> <td>RACCORDO GOMITO CODOLO Ø10F-Ø10M</td> <td>1.000</td> <td>PZ</td> </tr> <tr> <td>RC1396A0</td> <td>TERMINALE DRITTO JG D10-1/4</td> <td>2.000</td> <td>PZ</td> </tr> <tr> <td>VL1279A1</td> <td>RIDUTTORE DI PRESSIONE</td> <td>1.000</td> <td>PZ</td> </tr> </tbody> </table>	Code	Description	Qty	UOM	RC1243A0	RACCORDO GOMITO CODOLO Ø10F-Ø10M	1.000	PZ	RC1396A0	TERMINALE DRITTO JG D10-1/4	2.000	PZ	VL1279A1	RIDUTTORE DI PRESSIONE	1.000	PZ
			Code	Description	Qty	UOM																																																																						
RC1018A0	FASCETTA ELASTICA D12 ZINCATA	4.000	PZ																																																																									
RC1243A0	RACCORDO GOMITO CODOLO Ø10F-Ø10M	1.000	PZ																																																																									
RC1396A0	TERMINALE DRITTO JG D10-1/4	2.000	PZ																																																																									
TB3252A0	TB3132A-L=23 0MM EPDM BIANCO BLU	1.000	PZ																																																																									
TB3426A0	TB3132A-TUB O EPDM BIANCO BLU L90	1.000	PZ																																																																									
VI1220A1	VITE AUTOFIL. 4.2X11 TCS+ MARUTEX	2.000	PZ																																																																									
VL1014B3	RIDUTTORE DI PRESSIONE CON DISTRIBUTOR	1.000	PZ																																																																									
VL1095A0	RACCORDO DRITTO M-M PORTAGOMM A D7.8-D10	1.000	PZ																																																																									
VL1165A0	RACCORDO DRITTO BAM-BB6	2.000	PZ																																																																									
VM1054A0	GHIERA RIDUTTORE DI PRESSIONE H7.8	1.000	PZ																																																																									
VM1605A0	CLIP TWIST LOCK DIAM. 10,2-12,7 MM	1.000	PZ																																																																									
VM2652A0	SELLA DI CABLAGGIO	1.000	PZ																																																																									
Code	Description	Qty	UOM																																																																									
RC1243A0	RACCORDO GOMITO CODOLO Ø10F-Ø10M	1.000	PZ																																																																									
RC1396A0	TERMINALE DRITTO JG D10-1/4	2.000	PZ																																																																									
VL1279A1	RIDUTTORE DI PRESSIONE	1.000	PZ																																																																									

COMPONENT			SPARE PART																																																																																		
Code	Description	Image	Code	Description	Kit components																																																																																
RC1396A	TERMINALE DRITTO JG D10-1/4		KVL1315A	CBX RECIRCULATION BOX KIT (NO PUMPS)	<table border="1"> <thead> <tr> <th>Code</th> <th>Description</th> <th>Qty</th> <th>UOM</th> </tr> </thead> <tbody> <tr> <td>0H6686A0</td> <td>SOSTEGNO STAFFA IDRICA DID</td> <td>1.000</td> <td>PZ</td> </tr> <tr> <td>GN1400A0</td> <td>GUARNIZIONE SIFONE</td> <td>1.000</td> <td>PZ</td> </tr> <tr> <td>RC1019A0</td> <td>FASCETTA ELASTICA D10 ZINCATA</td> <td>2.000</td> <td>PZ</td> </tr> <tr> <td>RC1360A0</td> <td>RACCORDO GOMITO JG 10-10</td> <td>2.000</td> <td>PZ</td> </tr> <tr> <td>RC1378A0</td> <td>FASCETTA STRINGI TUBO D25-40 ZINCAT</td> <td>1.000</td> <td>PZ</td> </tr> <tr> <td>RC1410A0</td> <td>FASCETTA STRINGITUBO D16-27 INOX</td> <td>2.000</td> <td>PZ</td> </tr> <tr> <td>SN1053A0</td> <td>SENSORE DI LIVELLO</td> <td>1.000</td> <td>PZ</td> </tr> <tr> <td>SN1061A0</td> <td>SONDA NTC D4x175MM</td> <td>1.000</td> <td>PZ</td> </tr> <tr> <td>TB3822A0</td> <td>TB3454A-TUB O L 40 MM</td> <td>1.000</td> <td>PZ</td> </tr> <tr> <td>TB4135A0</td> <td>TB2820A-TUB O EPDM NERO L140MM</td> <td>1.000</td> <td>PZ</td> </tr> <tr> <td>TB4160A0</td> <td>TB2243A-TUB O PE TRASP D10 L150MM</td> <td>1.000</td> <td>PZ</td> </tr> <tr> <td>VI1103A0</td> <td>VITE PER PLASTICA 4X12 TPBS+ ZN-NI</td> <td>6.000</td> <td>PZ</td> </tr> <tr> <td>VI1189A0</td> <td>RONDELLA M5 INOX A4 D10 SP1</td> <td>2.000</td> <td>PZ</td> </tr> <tr> <td>VI1220A1</td> <td>VITE AUTOFIL. 4.2X11 TCS+ MARUTEX</td> <td>2.000</td> <td>PZ</td> </tr> <tr> <td>VL1178A0</td> <td>O-RING D INT 10.8 CORDA 1.78 EPDM</td> <td>2.000</td> <td>PZ</td> </tr> <tr> <td>VL1315A1</td> <td>ASM BLOCCO VASCA POMPE DID</td> <td>1.000</td> <td>PZ</td> </tr> <tr> <td>VL1332A0</td> <td>TAPPO VASCA DID</td> <td>1.000</td> <td>PZ</td> </tr> <tr> <td>VL1340A0</td> <td>ATTACCO BYPASS M-M JG10 DID</td> <td>1.000</td> <td>PZ</td> </tr> <tr> <td>VL1400A0</td> <td>CURVA SCARICO BORDO PARZIALE</td> <td>1.000</td> <td>PZ</td> </tr> </tbody> </table>	Code	Description	Qty	UOM	0H6686A0	SOSTEGNO STAFFA IDRICA DID	1.000	PZ	GN1400A0	GUARNIZIONE SIFONE	1.000	PZ	RC1019A0	FASCETTA ELASTICA D10 ZINCATA	2.000	PZ	RC1360A0	RACCORDO GOMITO JG 10-10	2.000	PZ	RC1378A0	FASCETTA STRINGI TUBO D25-40 ZINCAT	1.000	PZ	RC1410A0	FASCETTA STRINGITUBO D16-27 INOX	2.000	PZ	SN1053A0	SENSORE DI LIVELLO	1.000	PZ	SN1061A0	SONDA NTC D4x175MM	1.000	PZ	TB3822A0	TB3454A-TUB O L 40 MM	1.000	PZ	TB4135A0	TB2820A-TUB O EPDM NERO L140MM	1.000	PZ	TB4160A0	TB2243A-TUB O PE TRASP D10 L150MM	1.000	PZ	VI1103A0	VITE PER PLASTICA 4X12 TPBS+ ZN-NI	6.000	PZ	VI1189A0	RONDELLA M5 INOX A4 D10 SP1	2.000	PZ	VI1220A1	VITE AUTOFIL. 4.2X11 TCS+ MARUTEX	2.000	PZ	VL1178A0	O-RING D INT 10.8 CORDA 1.78 EPDM	2.000	PZ	VL1315A1	ASM BLOCCO VASCA POMPE DID	1.000	PZ	VL1332A0	TAPPO VASCA DID	1.000	PZ	VL1340A0	ATTACCO BYPASS M-M JG10 DID	1.000	PZ	VL1400A0	CURVA SCARICO BORDO PARZIALE	1.000	PZ
Code	Description	Qty	UOM																																																																																		
0H6686A0	SOSTEGNO STAFFA IDRICA DID	1.000	PZ																																																																																		
GN1400A0	GUARNIZIONE SIFONE	1.000	PZ																																																																																		
RC1019A0	FASCETTA ELASTICA D10 ZINCATA	2.000	PZ																																																																																		
RC1360A0	RACCORDO GOMITO JG 10-10	2.000	PZ																																																																																		
RC1378A0	FASCETTA STRINGI TUBO D25-40 ZINCAT	1.000	PZ																																																																																		
RC1410A0	FASCETTA STRINGITUBO D16-27 INOX	2.000	PZ																																																																																		
SN1053A0	SENSORE DI LIVELLO	1.000	PZ																																																																																		
SN1061A0	SONDA NTC D4x175MM	1.000	PZ																																																																																		
TB3822A0	TB3454A-TUB O L 40 MM	1.000	PZ																																																																																		
TB4135A0	TB2820A-TUB O EPDM NERO L140MM	1.000	PZ																																																																																		
TB4160A0	TB2243A-TUB O PE TRASP D10 L150MM	1.000	PZ																																																																																		
VI1103A0	VITE PER PLASTICA 4X12 TPBS+ ZN-NI	6.000	PZ																																																																																		
VI1189A0	RONDELLA M5 INOX A4 D10 SP1	2.000	PZ																																																																																		
VI1220A1	VITE AUTOFIL. 4.2X11 TCS+ MARUTEX	2.000	PZ																																																																																		
VL1178A0	O-RING D INT 10.8 CORDA 1.78 EPDM	2.000	PZ																																																																																		
VL1315A1	ASM BLOCCO VASCA POMPE DID	1.000	PZ																																																																																		
VL1332A0	TAPPO VASCA DID	1.000	PZ																																																																																		
VL1340A0	ATTACCO BYPASS M-M JG10 DID	1.000	PZ																																																																																		
VL1400A0	CURVA SCARICO BORDO PARZIALE	1.000	PZ																																																																																		

COMPONENT			SPARE PART																																																											
Code	Description	Image	Code	Description	Kit components																																																									
RC1396A	TERMINALE DRITTO JG D10-1/4		KVL1315A	CBX RECIRCULATION BOX KIT (NO PUMPS)	<table border="1"> <thead> <tr> <th>Code</th> <th>Description</th> <th>Qty</th> <th>UOM</th> </tr> </thead> <tbody> <tr> <td>VL1407A1</td> <td>ASM RIDUTTORE DI</td> <td>1.000</td> <td>PZ</td> </tr> <tr> <td>VM1802A0</td> <td>PERNO ROTAZIONE SPORTELLINO TANICHE DID</td> <td>1.000</td> <td>PZ</td> </tr> <tr> <td>VM2039A0</td> <td>ANELLO FISSAGGIO CURVA DI SCARICO</td> <td>1.000</td> <td>PZ</td> </tr> <tr> <td>VM2640A0</td> <td>PROTEZIONE POMPA SCARICO</td> <td>1.000</td> <td>PZ</td> </tr> </tbody> </table>	Code	Description	Qty	UOM	VL1407A1	ASM RIDUTTORE DI	1.000	PZ	VM1802A0	PERNO ROTAZIONE SPORTELLINO TANICHE DID	1.000	PZ	VM2039A0	ANELLO FISSAGGIO CURVA DI SCARICO	1.000	PZ	VM2640A0	PROTEZIONE POMPA SCARICO	1.000	PZ																																					
			Code	Description	Qty	UOM																																																								
VL1407A1	ASM RIDUTTORE DI	1.000	PZ																																																											
VM1802A0	PERNO ROTAZIONE SPORTELLINO TANICHE DID	1.000	PZ																																																											
VM2039A0	ANELLO FISSAGGIO CURVA DI SCARICO	1.000	PZ																																																											
VM2640A0	PROTEZIONE POMPA SCARICO	1.000	PZ																																																											
KVL1310A	COMPLETE CBX RECIRC TANK GROUP KIT	<table border="1"> <thead> <tr> <th>Code</th> <th>Description</th> <th>Qty</th> <th>UOM</th> </tr> </thead> <tbody> <tr> <td>0H5760A0</td> <td>COVER CONDENSATO RE CN1016</td> <td>1.000</td> <td>PZ</td> </tr> <tr> <td>0H6686A0</td> <td>SOSTEGNO STAFFA IDRICA DID</td> <td>1.000</td> <td>PZ</td> </tr> <tr> <td>CE2054A0</td> <td>CAVO RAST 5 POMPA DI SCARICO</td> <td>1.000</td> <td>PZ</td> </tr> <tr> <td>CE2055A0</td> <td>CAVO RAST 5 POMPA RICIRCOLO</td> <td>1.000</td> <td>PZ</td> </tr> <tr> <td>CN1016A0</td> <td>CONDENSATO RE 2.5 uF 500V CE/UL</td> <td>1.000</td> <td>PZ</td> </tr> <tr> <td>GN1400A0</td> <td>GUARNIZIONE SIFONE</td> <td>1.000</td> <td>PZ</td> </tr> <tr> <td>PM1013A0</td> <td>POMPA SCARICO 240V 32W</td> <td>1.000</td> <td>PZ</td> </tr> <tr> <td>PM1018A0</td> <td>POMPA RICIRCOLO 240V 100W</td> <td>1.000</td> <td>PZ</td> </tr> <tr> <td>RC1019A0</td> <td>FASCETTA ELASTICA D10 ZINCATA</td> <td>2.000</td> <td>PZ</td> </tr> <tr> <td>RC1046A0</td> <td>FASCETTA STRINGI TUBO D10-16 H9 INO</td> <td>1.000</td> <td>PZ</td> </tr> <tr> <td>RC1360A0</td> <td>RACCORDO GOMITO JG 10-10</td> <td>2.000</td> <td>PZ</td> </tr> <tr> <td>RC1378A0</td> <td>FASCETTA STRINGI TUBO D25-40 ZINCAT</td> <td>1.000</td> <td>PZ</td> </tr> <tr> <td>RC1410A0</td> <td>FASCETTA STRINGITUBO D16-27 INOX</td> <td>6.000</td> <td>PZ</td> </tr> <tr> <td>SN1053A0</td> <td>SENSORE DI LIVELLO</td> <td>1.000</td> <td>PZ</td> </tr> </tbody> </table>	Code	Description	Qty	UOM	0H5760A0	COVER CONDENSATO RE CN1016	1.000	PZ	0H6686A0	SOSTEGNO STAFFA IDRICA DID	1.000	PZ	CE2054A0	CAVO RAST 5 POMPA DI SCARICO	1.000	PZ	CE2055A0	CAVO RAST 5 POMPA RICIRCOLO	1.000	PZ	CN1016A0	CONDENSATO RE 2.5 uF 500V CE/UL	1.000	PZ	GN1400A0	GUARNIZIONE SIFONE	1.000	PZ	PM1013A0	POMPA SCARICO 240V 32W	1.000	PZ	PM1018A0	POMPA RICIRCOLO 240V 100W	1.000	PZ	RC1019A0	FASCETTA ELASTICA D10 ZINCATA	2.000	PZ	RC1046A0	FASCETTA STRINGI TUBO D10-16 H9 INO	1.000	PZ	RC1360A0	RACCORDO GOMITO JG 10-10	2.000	PZ	RC1378A0	FASCETTA STRINGI TUBO D25-40 ZINCAT	1.000	PZ	RC1410A0	FASCETTA STRINGITUBO D16-27 INOX	6.000	PZ	SN1053A0	SENSORE DI LIVELLO	1.000	PZ
Code	Description	Qty	UOM																																																											
0H5760A0	COVER CONDENSATO RE CN1016	1.000	PZ																																																											
0H6686A0	SOSTEGNO STAFFA IDRICA DID	1.000	PZ																																																											
CE2054A0	CAVO RAST 5 POMPA DI SCARICO	1.000	PZ																																																											
CE2055A0	CAVO RAST 5 POMPA RICIRCOLO	1.000	PZ																																																											
CN1016A0	CONDENSATO RE 2.5 uF 500V CE/UL	1.000	PZ																																																											
GN1400A0	GUARNIZIONE SIFONE	1.000	PZ																																																											
PM1013A0	POMPA SCARICO 240V 32W	1.000	PZ																																																											
PM1018A0	POMPA RICIRCOLO 240V 100W	1.000	PZ																																																											
RC1019A0	FASCETTA ELASTICA D10 ZINCATA	2.000	PZ																																																											
RC1046A0	FASCETTA STRINGI TUBO D10-16 H9 INO	1.000	PZ																																																											
RC1360A0	RACCORDO GOMITO JG 10-10	2.000	PZ																																																											
RC1378A0	FASCETTA STRINGI TUBO D25-40 ZINCAT	1.000	PZ																																																											
RC1410A0	FASCETTA STRINGITUBO D16-27 INOX	6.000	PZ																																																											
SN1053A0	SENSORE DI LIVELLO	1.000	PZ																																																											

COMPONENT			SPARE PART																																																																																		
Code	Description	Image	Code	Description	Kit components																																																																																
RC1396A	TERMINALE DRITTO JG D10-1/4		KVL1310A	COMPLETE CBX RECIRC TANK GROUP KIT	<table border="1"> <thead> <tr> <th>Code</th> <th>Description</th> <th>Qty</th> <th>UOM</th> </tr> </thead> <tbody> <tr> <td>SN1061A0</td> <td>SONDA NTC D4x175MM</td> <td>1.000</td> <td>PZ</td> </tr> <tr> <td>TB3822A0</td> <td>TB3454A-TUB O L 40 MM</td> <td>2.000</td> <td>PZ</td> </tr> <tr> <td>TB4135A0</td> <td>TB2820A-TUB O EPDM NERO L140MM</td> <td>1.000</td> <td>PZ</td> </tr> <tr> <td>TB4160A0</td> <td>TB2243A-TUB O PE TRASP D10 L150MM</td> <td>1.000</td> <td>PZ</td> </tr> <tr> <td>VI1103A0</td> <td>VITE PER PLASTICA 4X12 TPBS+ ZN-NI</td> <td>9.000</td> <td>PZ</td> </tr> <tr> <td>VI1220A1</td> <td>VITE AUTOFIL. 4.2X11 TCS+ MARUTEX</td> <td>2.000</td> <td>PZ</td> </tr> <tr> <td>VI1931A0</td> <td>DADO CONDENSATO RE M8x1.65 H4 CH13 ZINC</td> <td>1.000</td> <td>PZ</td> </tr> <tr> <td>VL1178A0</td> <td>O-RING D INT 10.8 CORDA 1.78 EPDM</td> <td>2.000</td> <td>PZ</td> </tr> <tr> <td>VL1315A1</td> <td>ASM BLOCCO VASCA POMPE DID</td> <td>1.000</td> <td>PZ</td> </tr> <tr> <td>VL1318A1</td> <td>SUPPORTO POMPA RICIRCOLO CBX</td> <td>1.000</td> <td>PZ</td> </tr> <tr> <td>VL1329A0</td> <td>RACCORDO D24-D16</td> <td>1.000</td> <td>PZ</td> </tr> <tr> <td>VL1332A0</td> <td>TAPPO VASCA DID</td> <td>1.000</td> <td>PZ</td> </tr> <tr> <td>VL1340A0</td> <td>ATTACCO BYPASS M-M JG10 DID</td> <td>1.000</td> <td>PZ</td> </tr> <tr> <td>VL1400A0</td> <td>CURVA SCARICO BORDO PARZIALE</td> <td>1.000</td> <td>PZ</td> </tr> <tr> <td>VL1407A1</td> <td>ASM RIDUTTORE DI</td> <td>1.000</td> <td>PZ</td> </tr> <tr> <td>VM1794A0</td> <td>FASCETTA 430X4.8 PA66 NERA</td> <td>1.000</td> <td>PZ</td> </tr> <tr> <td>VM1802A0</td> <td>PERNO ROTAZIONE SPORTELLINO TANICHE DID</td> <td>1.000</td> <td>PZ</td> </tr> <tr> <td>VM2039A0</td> <td>ANELLO FISSAGGIO CURVA DI SCARICO</td> <td>1.000</td> <td>PZ</td> </tr> <tr> <td>VM2640A0</td> <td>PROTEZIONE POMPA SCARICO</td> <td>1.000</td> <td>PZ</td> </tr> </tbody> </table>	Code	Description	Qty	UOM	SN1061A0	SONDA NTC D4x175MM	1.000	PZ	TB3822A0	TB3454A-TUB O L 40 MM	2.000	PZ	TB4135A0	TB2820A-TUB O EPDM NERO L140MM	1.000	PZ	TB4160A0	TB2243A-TUB O PE TRASP D10 L150MM	1.000	PZ	VI1103A0	VITE PER PLASTICA 4X12 TPBS+ ZN-NI	9.000	PZ	VI1220A1	VITE AUTOFIL. 4.2X11 TCS+ MARUTEX	2.000	PZ	VI1931A0	DADO CONDENSATO RE M8x1.65 H4 CH13 ZINC	1.000	PZ	VL1178A0	O-RING D INT 10.8 CORDA 1.78 EPDM	2.000	PZ	VL1315A1	ASM BLOCCO VASCA POMPE DID	1.000	PZ	VL1318A1	SUPPORTO POMPA RICIRCOLO CBX	1.000	PZ	VL1329A0	RACCORDO D24-D16	1.000	PZ	VL1332A0	TAPPO VASCA DID	1.000	PZ	VL1340A0	ATTACCO BYPASS M-M JG10 DID	1.000	PZ	VL1400A0	CURVA SCARICO BORDO PARZIALE	1.000	PZ	VL1407A1	ASM RIDUTTORE DI	1.000	PZ	VM1794A0	FASCETTA 430X4.8 PA66 NERA	1.000	PZ	VM1802A0	PERNO ROTAZIONE SPORTELLINO TANICHE DID	1.000	PZ	VM2039A0	ANELLO FISSAGGIO CURVA DI SCARICO	1.000	PZ	VM2640A0	PROTEZIONE POMPA SCARICO	1.000	PZ
Code	Description	Qty	UOM																																																																																		
SN1061A0	SONDA NTC D4x175MM	1.000	PZ																																																																																		
TB3822A0	TB3454A-TUB O L 40 MM	2.000	PZ																																																																																		
TB4135A0	TB2820A-TUB O EPDM NERO L140MM	1.000	PZ																																																																																		
TB4160A0	TB2243A-TUB O PE TRASP D10 L150MM	1.000	PZ																																																																																		
VI1103A0	VITE PER PLASTICA 4X12 TPBS+ ZN-NI	9.000	PZ																																																																																		
VI1220A1	VITE AUTOFIL. 4.2X11 TCS+ MARUTEX	2.000	PZ																																																																																		
VI1931A0	DADO CONDENSATO RE M8x1.65 H4 CH13 ZINC	1.000	PZ																																																																																		
VL1178A0	O-RING D INT 10.8 CORDA 1.78 EPDM	2.000	PZ																																																																																		
VL1315A1	ASM BLOCCO VASCA POMPE DID	1.000	PZ																																																																																		
VL1318A1	SUPPORTO POMPA RICIRCOLO CBX	1.000	PZ																																																																																		
VL1329A0	RACCORDO D24-D16	1.000	PZ																																																																																		
VL1332A0	TAPPO VASCA DID	1.000	PZ																																																																																		
VL1340A0	ATTACCO BYPASS M-M JG10 DID	1.000	PZ																																																																																		
VL1400A0	CURVA SCARICO BORDO PARZIALE	1.000	PZ																																																																																		
VL1407A1	ASM RIDUTTORE DI	1.000	PZ																																																																																		
VM1794A0	FASCETTA 430X4.8 PA66 NERA	1.000	PZ																																																																																		
VM1802A0	PERNO ROTAZIONE SPORTELLINO TANICHE DID	1.000	PZ																																																																																		
VM2039A0	ANELLO FISSAGGIO CURVA DI SCARICO	1.000	PZ																																																																																		
VM2640A0	PROTEZIONE POMPA SCARICO	1.000	PZ																																																																																		

COMPONENT			SPARE PART																																																																					
Code	Description	Image	Code	Description	Kit components																																																																			
RC1396A	TERMINALE DRITTO JG D10-1/4		KVL1163A	MIND.Maps INLET CONNECTING PIPE KIT	<table border="1"> <thead> <tr> <th>Code</th> <th>Description</th> <th>Qty</th> <th>UOM</th> </tr> </thead> <tbody> <tr> <td>0H8038A0</td> <td>LAMIERA SUPPORTO RIDUTTORE M</td> <td>1.000</td> <td>PZ</td> </tr> <tr> <td>0H8039A0</td> <td>LAMIERA SUPPORTO RIDUTTORE COMPACT MM</td> <td>1.000</td> <td>PZ</td> </tr> <tr> <td>CH1026A0</td> <td>CHIAVE J.G. UNOX D8-D10</td> <td>1.000</td> <td>PZ</td> </tr> <tr> <td>RC1243A0</td> <td>RACCORDO GOMITO CODOLO Ø10F-Ø10M</td> <td>2.000</td> <td>PZ</td> </tr> <tr> <td>RC1396A0</td> <td>TERMINALE DRITTO JG D10-1/4</td> <td>2.000</td> <td>PZ</td> </tr> <tr> <td>TB2243A0</td> <td>TUBO D10 PE TRASPARENT</td> <td>0.050</td> <td>M</td> </tr> <tr> <td>VI1220A1</td> <td>VITE AUTOFIL. 4.2X11 TCS+ MARUTEX</td> <td>2.000</td> <td>PZ</td> </tr> <tr> <td>VI1950A0</td> <td>VITE AUTOFORANT E 4,2X13 TCB INOX</td> <td>1.000</td> <td>PZ</td> </tr> <tr> <td>VL1014B3</td> <td>RIDUTTORE DI PRESSIONE CON DISTRIBUTOR</td> <td>1.000</td> <td>PZ</td> </tr> <tr> <td>VL1135A1</td> <td>RACCORDO 3/4-JG10 CON FILTRO E VNR</td> <td>1.000</td> <td>PZ</td> </tr> <tr> <td>VM1054A0</td> <td>GHIERA RIDUTTORE DI PRESSIONE H7.8</td> <td>1.000</td> <td>PZ</td> </tr> </tbody> </table>	Code	Description	Qty	UOM	0H8038A0	LAMIERA SUPPORTO RIDUTTORE M	1.000	PZ	0H8039A0	LAMIERA SUPPORTO RIDUTTORE COMPACT MM	1.000	PZ	CH1026A0	CHIAVE J.G. UNOX D8-D10	1.000	PZ	RC1243A0	RACCORDO GOMITO CODOLO Ø10F-Ø10M	2.000	PZ	RC1396A0	TERMINALE DRITTO JG D10-1/4	2.000	PZ	TB2243A0	TUBO D10 PE TRASPARENT	0.050	M	VI1220A1	VITE AUTOFIL. 4.2X11 TCS+ MARUTEX	2.000	PZ	VI1950A0	VITE AUTOFORANT E 4,2X13 TCB INOX	1.000	PZ	VL1014B3	RIDUTTORE DI PRESSIONE CON DISTRIBUTOR	1.000	PZ	VL1135A1	RACCORDO 3/4-JG10 CON FILTRO E VNR	1.000	PZ	VM1054A0	GHIERA RIDUTTORE DI PRESSIONE H7.8	1.000	PZ	KVL0020A	PRESS.REDUCER 03-05XX≥OCT18/MM -LUX≥MAR19	<table border="1"> <thead> <tr> <th>Code</th> <th>Description</th> <th>Qty</th> <th>UOM</th> </tr> </thead> <tbody> <tr> <td>RC1396A0</td> <td>TERMINALE DRITTO JG D10-1/4</td> <td>2.000</td> <td>PZ</td> </tr> <tr> <td>VL1014B3</td> <td>RIDUTTORE DI PRESSIONE CON DISTRIBUTOR</td> <td>1.000</td> <td>PZ</td> </tr> <tr> <td>VM1054A0</td> <td>GHIERA RIDUTTORE DI PRESSIONE H7.8</td> <td>1.000</td> <td>PZ</td> </tr> </tbody> </table>	Code	Description	Qty	UOM	RC1396A0	TERMINALE DRITTO JG D10-1/4	2.000	PZ	VL1014B3	RIDUTTORE DI PRESSIONE CON DISTRIBUTOR	1.000	PZ	VM1054A0	GHIERA RIDUTTORE DI PRESSIONE H7.8	1.000	PZ
			Code	Description	Qty	UOM																																																																		
0H8038A0	LAMIERA SUPPORTO RIDUTTORE M	1.000	PZ																																																																					
0H8039A0	LAMIERA SUPPORTO RIDUTTORE COMPACT MM	1.000	PZ																																																																					
CH1026A0	CHIAVE J.G. UNOX D8-D10	1.000	PZ																																																																					
RC1243A0	RACCORDO GOMITO CODOLO Ø10F-Ø10M	2.000	PZ																																																																					
RC1396A0	TERMINALE DRITTO JG D10-1/4	2.000	PZ																																																																					
TB2243A0	TUBO D10 PE TRASPARENT	0.050	M																																																																					
VI1220A1	VITE AUTOFIL. 4.2X11 TCS+ MARUTEX	2.000	PZ																																																																					
VI1950A0	VITE AUTOFORANT E 4,2X13 TCB INOX	1.000	PZ																																																																					
VL1014B3	RIDUTTORE DI PRESSIONE CON DISTRIBUTOR	1.000	PZ																																																																					
VL1135A1	RACCORDO 3/4-JG10 CON FILTRO E VNR	1.000	PZ																																																																					
VM1054A0	GHIERA RIDUTTORE DI PRESSIONE H7.8	1.000	PZ																																																																					
Code	Description	Qty	UOM																																																																					
RC1396A0	TERMINALE DRITTO JG D10-1/4	2.000	PZ																																																																					
VL1014B3	RIDUTTORE DI PRESSIONE CON DISTRIBUTOR	1.000	PZ																																																																					
VM1054A0	GHIERA RIDUTTORE DI PRESSIONE H7.8	1.000	PZ																																																																					

COMPONENT			SPARE PART																																											
Code	Description	Image	Code	Description	Kit components																																									
RC1396A	TERMINALE DRITTO JG D10-1/4		KVL0014B	MIND.MAPS 2017-2018 PRESSURE REDUCER KIT	<table border="1"> <thead> <tr> <th>Code</th> <th>Description</th> <th>Qty</th> <th>UOM</th> </tr> </thead> <tbody> <tr> <td>RC1372A0</td> <td>RACCORDO DRITTO Ø10M-1/4 M CI</td> <td>1.000</td> <td>PZ</td> </tr> <tr> <td>RC1396A0</td> <td>TERMINALE DRITTO JG D10-1/4</td> <td>1.000</td> <td>PZ</td> </tr> <tr> <td>VL1014B3</td> <td>RIDUTTORE DI PRESSIONE CON DISTRIBUTOR</td> <td>1.000</td> <td>PZ</td> </tr> <tr> <td>VM1054A0</td> <td>GHIERA RIDUTTORE DI PRESSIONE H7.8</td> <td>1.000</td> <td>PZ</td> </tr> </tbody> </table>	Code	Description	Qty	UOM	RC1372A0	RACCORDO DRITTO Ø10M-1/4 M CI	1.000	PZ	RC1396A0	TERMINALE DRITTO JG D10-1/4	1.000	PZ	VL1014B3	RIDUTTORE DI PRESSIONE CON DISTRIBUTOR	1.000	PZ	VM1054A0	GHIERA RIDUTTORE DI PRESSIONE H7.8	1.000	PZ																					
			Code	Description	Qty	UOM																																								
RC1372A0	RACCORDO DRITTO Ø10M-1/4 M CI	1.000	PZ																																											
RC1396A0	TERMINALE DRITTO JG D10-1/4	1.000	PZ																																											
VL1014B3	RIDUTTORE DI PRESSIONE CON DISTRIBUTOR	1.000	PZ																																											
VM1054A0	GHIERA RIDUTTORE DI PRESSIONE H7.8	1.000	PZ																																											
KVA0003B	MIND.MAPS -M SUGGESTED PARTS KIT	<table border="1"> <thead> <tr> <th>Code</th> <th>Description</th> <th>Qty</th> <th>UOM</th> </tr> </thead> <tbody> <tr> <td>0H2842A0</td> <td>MASCHERA CENTRAGGIO MT1012</td> <td>1.000</td> <td>PZ</td> </tr> <tr> <td>0H8118A0</td> <td>DISCO TENUTA ALBERO MOTORE XEVL</td> <td>1.000</td> <td>PZ</td> </tr> <tr> <td>0H8119A0</td> <td>COPERCHIO INGRESSO SONDA CUORE XEVL 316</td> <td>1.000</td> <td>PZ</td> </tr> <tr> <td>0H8120A0</td> <td>COPERCHIO INGRESSO BULBO XEVL</td> <td>1.000</td> <td>PZ</td> </tr> <tr> <td>CE1052A1</td> <td>CAVO CONNESSION E CONTROLLO- USB MM 750m</td> <td>1.000</td> <td>PZ</td> </tr> <tr> <td>CE1061A0</td> <td>CAVO ADATTATORE MINIFIT PLUG 2P-FC L100</td> <td>1.000</td> <td>PZ</td> </tr> <tr> <td>CE1685A0</td> <td>MORSETTO FEMMINA ESTR. MRT8 P3.81 5P</td> <td>1.000</td> <td>PZ</td> </tr> <tr> <td>CE2007A0</td> <td>CAVO MICROFIT 4PM-MINIFIT 4PF 100mm</td> <td>1.000</td> <td>PZ</td> </tr> <tr> <td>CN1003A0</td> <td>CONDENSATO RE CORAZZATO 6,3 uF</td> <td>2.000</td> <td>PZ</td> </tr> <tr> <td>GN1140A3</td> <td>GUARNIZIONE PORTAMOTO RE STAMPAT</td> <td>1.000</td> <td>PZ</td> </tr> </tbody> </table>	Code	Description	Qty	UOM	0H2842A0	MASCHERA CENTRAGGIO MT1012	1.000	PZ	0H8118A0	DISCO TENUTA ALBERO MOTORE XEVL	1.000	PZ	0H8119A0	COPERCHIO INGRESSO SONDA CUORE XEVL 316	1.000	PZ	0H8120A0	COPERCHIO INGRESSO BULBO XEVL	1.000	PZ	CE1052A1	CAVO CONNESSION E CONTROLLO- USB MM 750m	1.000	PZ	CE1061A0	CAVO ADATTATORE MINIFIT PLUG 2P-FC L100	1.000	PZ	CE1685A0	MORSETTO FEMMINA ESTR. MRT8 P3.81 5P	1.000	PZ	CE2007A0	CAVO MICROFIT 4PM-MINIFIT 4PF 100mm	1.000	PZ	CN1003A0	CONDENSATO RE CORAZZATO 6,3 uF	2.000	PZ	GN1140A3	GUARNIZIONE PORTAMOTO RE STAMPAT	1.000	PZ
Code	Description	Qty	UOM																																											
0H2842A0	MASCHERA CENTRAGGIO MT1012	1.000	PZ																																											
0H8118A0	DISCO TENUTA ALBERO MOTORE XEVL	1.000	PZ																																											
0H8119A0	COPERCHIO INGRESSO SONDA CUORE XEVL 316	1.000	PZ																																											
0H8120A0	COPERCHIO INGRESSO BULBO XEVL	1.000	PZ																																											
CE1052A1	CAVO CONNESSION E CONTROLLO- USB MM 750m	1.000	PZ																																											
CE1061A0	CAVO ADATTATORE MINIFIT PLUG 2P-FC L100	1.000	PZ																																											
CE1685A0	MORSETTO FEMMINA ESTR. MRT8 P3.81 5P	1.000	PZ																																											
CE2007A0	CAVO MICROFIT 4PM-MINIFIT 4PF 100mm	1.000	PZ																																											
CN1003A0	CONDENSATO RE CORAZZATO 6,3 uF	2.000	PZ																																											
GN1140A3	GUARNIZIONE PORTAMOTO RE STAMPAT	1.000	PZ																																											

COMPONENT			SPARE PART			
Code	Description	Image	Code	Description	Kit components	
RC1396A	TERMINALE DRITTO JG D10-1/4		KVA0003B	MIND.MAPS -M SUGGESTED PARTS KIT	Code	Description Qty UOM
					GN1531A0	GUARNIZIONE 1.000 PZ TENUTA INGRESSO BULBO
					GN1632A0	GUARNIZIONE 1.000 PZ TENUTA INGRESSO SONDA-CUOR
					GN1672A1	GUARNIZIONE 1.000 PZ RS FRENATA
					JEM0576A0	ASSEMBLAGG 1.000 PZ IO RID. PRESSIONE PER KVL0020A
					MG1099A1	ASSIEME 1.000 PZ MANIGLIA COMPLETO MMc
					MT1012A0	MOTORE 1.000 PZ SIMMETRICO 330W 230V ALBERO D12
					PE1057B0	CRUSCOTTO 1.000 PZ COMPLETO CAP MM PLUS
					PE1058A2	CRUSCOTTO 1.000 PZ COMPLETO MM ONE
					PE1059A0	ASM 1.000 PZ SUPPORTO USB-RESET M
					PE1710B1	SENSORE 1.000 PZ MODULARE NUM GIRI E DIREZIONE
					PE2037A0	SCHEDA 1.000 PZ POTENZA MM ONE
					PE2038A0	SCHEDA 1.000 PZ POTENZA MM PLUS
					RC1019A0	FASCETTA 5.000 PZ ELASTICA D10 ZINCATA
					RC1414A1	FASCETTA 4.000 PZ STRINGITUBO A SCATTO D11.5-12.5
					RS1034A0	RES PIANA 1.000 PZ 147W 105V 1 SPIRA CON CONCA

COMPONENT			SPARE PART																																																																						
Code	Description	Image	Code	Description	Kit components																																																																				
RC1396A	TERMINALE DRITTO JG D10-1/4		KVA0003B	MIND.MAPS -M SUGGESTED PARTS KIT	<table border="1"> <thead> <tr> <th>Code</th> <th>Description</th> <th>Qty</th> <th>UOM</th> </tr> </thead> <tbody> <tr> <td>RS1036A0</td> <td>RES PIANA 100W 60V 1 SPIRA CON CONCA</td> <td>1.000</td> <td>PZ</td> </tr> <tr> <td>SL1045A0</td> <td>SILICONE ANTRACITE S57 80 ml</td> <td>1.000</td> <td>PZ</td> </tr> <tr> <td>SN1002B2</td> <td>SONDA CUORE MULTIP DRITTA L2050 NO RACC</td> <td>1.000</td> <td>PZ</td> </tr> <tr> <td>TB2821A0</td> <td>TB2820A-L=40 MM EPDM NER</td> <td>1.000</td> <td>PZ</td> </tr> <tr> <td>TB3225B0</td> <td>TB2820A-TUB O EPDM NERO 670MM</td> <td>1.000</td> <td>PZ</td> </tr> <tr> <td>TR1136A0</td> <td>TERMOSTATO SIC. UNIP. 318°C -0/+24</td> <td>1.000</td> <td>PZ</td> </tr> <tr> <td>VE1020B0</td> <td>MICROINT. PORTA MAGNETICO CON MINIFIT 2</td> <td>1.000</td> <td>PZ</td> </tr> <tr> <td>VE1026A0</td> <td>TRASFORMAT ORE 230-21-12Vac 90VA</td> <td>1.000</td> <td>PZ</td> </tr> <tr> <td>VE1030A1</td> <td>CALAMITA D=22,9mm PER MICROPORTA</td> <td>1.000</td> <td>PZ</td> </tr> <tr> <td>VE1639A0</td> <td>TRASFORMAT ORE 230-12Vac 60V</td> <td>1.000</td> <td>PZ</td> </tr> <tr> <td>VI1074A0</td> <td>VITE PER PLASTICA 4X16 TPBS+ INOX</td> <td>2.000</td> <td>PZ</td> </tr> <tr> <td>VI1077A1</td> <td>VITE M6x12 TE INOX</td> <td>1.000</td> <td>PZ</td> </tr> <tr> <td>VI1122A0</td> <td>VITE M6X12 TE INOX A4 316</td> <td>1.000</td> <td>PZ</td> </tr> <tr> <td>VI1123A0</td> <td>RONDELLA PIANA M6 INOX A4 AISI316</td> <td>1.000</td> <td>PZ</td> </tr> <tr> <td>VI1192A0</td> <td>DADO M10X0.75 H3 OTTONE NICHELATO</td> <td>1.000</td> <td>PZ</td> </tr> <tr> <td>VI1220A1</td> <td>VITE AUTOFIL. 4.2X11 TCS+ MARUTEX</td> <td>3.000</td> <td>PZ</td> </tr> </tbody> </table>	Code	Description	Qty	UOM	RS1036A0	RES PIANA 100W 60V 1 SPIRA CON CONCA	1.000	PZ	SL1045A0	SILICONE ANTRACITE S57 80 ml	1.000	PZ	SN1002B2	SONDA CUORE MULTIP DRITTA L2050 NO RACC	1.000	PZ	TB2821A0	TB2820A-L=40 MM EPDM NER	1.000	PZ	TB3225B0	TB2820A-TUB O EPDM NERO 670MM	1.000	PZ	TR1136A0	TERMOSTATO SIC. UNIP. 318°C -0/+24	1.000	PZ	VE1020B0	MICROINT. PORTA MAGNETICO CON MINIFIT 2	1.000	PZ	VE1026A0	TRASFORMAT ORE 230-21-12Vac 90VA	1.000	PZ	VE1030A1	CALAMITA D=22,9mm PER MICROPORTA	1.000	PZ	VE1639A0	TRASFORMAT ORE 230-12Vac 60V	1.000	PZ	VI1074A0	VITE PER PLASTICA 4X16 TPBS+ INOX	2.000	PZ	VI1077A1	VITE M6x12 TE INOX	1.000	PZ	VI1122A0	VITE M6X12 TE INOX A4 316	1.000	PZ	VI1123A0	RONDELLA PIANA M6 INOX A4 AISI316	1.000	PZ	VI1192A0	DADO M10X0.75 H3 OTTONE NICHELATO	1.000	PZ	VI1220A1	VITE AUTOFIL. 4.2X11 TCS+ MARUTEX	3.000	PZ
Code	Description	Qty	UOM																																																																						
RS1036A0	RES PIANA 100W 60V 1 SPIRA CON CONCA	1.000	PZ																																																																						
SL1045A0	SILICONE ANTRACITE S57 80 ml	1.000	PZ																																																																						
SN1002B2	SONDA CUORE MULTIP DRITTA L2050 NO RACC	1.000	PZ																																																																						
TB2821A0	TB2820A-L=40 MM EPDM NER	1.000	PZ																																																																						
TB3225B0	TB2820A-TUB O EPDM NERO 670MM	1.000	PZ																																																																						
TR1136A0	TERMOSTATO SIC. UNIP. 318°C -0/+24	1.000	PZ																																																																						
VE1020B0	MICROINT. PORTA MAGNETICO CON MINIFIT 2	1.000	PZ																																																																						
VE1026A0	TRASFORMAT ORE 230-21-12Vac 90VA	1.000	PZ																																																																						
VE1030A1	CALAMITA D=22,9mm PER MICROPORTA	1.000	PZ																																																																						
VE1639A0	TRASFORMAT ORE 230-12Vac 60V	1.000	PZ																																																																						
VI1074A0	VITE PER PLASTICA 4X16 TPBS+ INOX	2.000	PZ																																																																						
VI1077A1	VITE M6x12 TE INOX	1.000	PZ																																																																						
VI1122A0	VITE M6X12 TE INOX A4 316	1.000	PZ																																																																						
VI1123A0	RONDELLA PIANA M6 INOX A4 AISI316	1.000	PZ																																																																						
VI1192A0	DADO M10X0.75 H3 OTTONE NICHELATO	1.000	PZ																																																																						
VI1220A1	VITE AUTOFIL. 4.2X11 TCS+ MARUTEX	3.000	PZ																																																																						

COMPONENT			SPARE PART					
Code	Description	Image	Code	Description	Kit components			
RC1396A	TERMINALE DRITTO JG D10-1/4		KVA0003B	MIND.MAPS -M SUGGESTED PARTS KIT	Code	Description	Qty	UOM
					VI1521A0	RONDELLA PIANA 6x12x1 INOX	1.000	PZ
					VI1850A0	VITE M4X6 TCB+ NICHELATA	12.000	PZ
					VI1931A0	DADO CONDENSATO RE M8x1.65 H4 CH13 ZINC	2.000	PZ
					VI1932A0	RONDELLA DENPELLATA CONDENSATO RE D8 ZINC	2.000	PZ
					VI1950A0	VITE AUTOFORANT E 4,2X13 TCB INOX	4.000	PZ
					VI1966A1	VITE M4X14 TSP+ ZN	1.000	PZ
					VL1047A1	PORTAGOMM A D6 CODOLO D8	1.000	PZ
					VL1102A1	FILTRO IN LINEA DET. + VNR BARBED 6 MM	1.000	PZ
					VL1182A3	ASM LAVAGGIO ONE MONO GIRANTE	1.000	PZ
					VL1183A2	ASM LAVAGGIO PLUS MONO GIRANTE	1.000	PZ
					VM1447A0	BUSTA AIRBALL ESD ROSA 230X450 MM	0.500	PZ
					VM1490A0	COPRI VITI MANIGLIA CHEFTOP BAKERTOP	2.000	PZ
					VM1605A0	CLIP TWIST LOCK DIAM. 10,2-12,7 MM	3.000	PZ
					VM1745A0	SUPPORTO PER SCHEDA	9.000	PZ
					VM2295A1	PENNINO CONTROLLO MM	1.000	PZ
					VM2880A0	ASM MGT MISURA NUMERO GIRI	1.000	PZ

COMPONENT			SPARE PART																															
Code	Description	Image	Code	Description	Kit components																													
RC1396A	TERMINALE DRITTO JG D10-1/4		KVA0003B	MIND.MAPS -M SUGGESTED PARTS KIT	<table border="1"> <thead> <tr> <th>Code</th> <th>Description</th> <th>Qty</th> <th>UOM</th> </tr> </thead> <tbody> <tr> <td>VN1184A0</td> <td>VENTOLA D195 H80 PALE SCARICATE</td> <td>1.000</td> <td>PZ</td> </tr> <tr> <td>VP1005A0</td> <td>SUPPORTO CONTROLLO PORTA BIG-L</td> <td>1.000</td> <td>PZ</td> </tr> <tr> <td>VP1005B0</td> <td>SUPPORTO CONTROLLO BIG-L PORTA 70 MM</td> <td>1.000</td> <td>PZ</td> </tr> <tr> <td>VP1067A0</td> <td>DISTANZIALE RETROFIT PER CONTROLLO MM</td> <td>1.000</td> <td>PZ</td> </tr> <tr> <td>VP1078A0</td> <td>CORNICE RETROFIT PER CONTROLLO MM</td> <td>1.000</td> <td>PZ</td> </tr> </tbody> </table>	Code	Description	Qty	UOM	VN1184A0	VENTOLA D195 H80 PALE SCARICATE	1.000	PZ	VP1005A0	SUPPORTO CONTROLLO PORTA BIG-L	1.000	PZ	VP1005B0	SUPPORTO CONTROLLO BIG-L PORTA 70 MM	1.000	PZ	VP1067A0	DISTANZIALE RETROFIT PER CONTROLLO MM	1.000	PZ	VP1078A0	CORNICE RETROFIT PER CONTROLLO MM	1.000	PZ					
			Code	Description	Qty	UOM																												
			VN1184A0	VENTOLA D195 H80 PALE SCARICATE	1.000	PZ																												
			VP1005A0	SUPPORTO CONTROLLO PORTA BIG-L	1.000	PZ																												
			VP1005B0	SUPPORTO CONTROLLO BIG-L PORTA 70 MM	1.000	PZ																												
			VP1067A0	DISTANZIALE RETROFIT PER CONTROLLO MM	1.000	PZ																												
			VP1078A0	CORNICE RETROFIT PER CONTROLLO MM	1.000	PZ																												
			KRC1396A	JG D10-1/4 STRAIGHT END FITTING KIT	<table border="1"> <thead> <tr> <th>Code</th> <th>Description</th> <th>Qty</th> <th>UOM</th> </tr> </thead> <tbody> <tr> <td>RC1396A0</td> <td>TERMINALE DRITTO JG D10-1/4</td> <td>1.000</td> <td>PZ</td> </tr> </tbody> </table>	Code	Description	Qty	UOM	RC1396A0	TERMINALE DRITTO JG D10-1/4	1.000	PZ																					
			Code	Description	Qty	UOM																												
			RC1396A0	TERMINALE DRITTO JG D10-1/4	1.000	PZ																												
K0H8734A	PROVER DOOR MICROSWITCH KIT	<table border="1"> <thead> <tr> <th>Code</th> <th>Description</th> <th>Qty</th> <th>UOM</th> </tr> </thead> <tbody> <tr> <td>0H8734A0</td> <td>SCATOLA MICRO PORTA LIEVITATORE</td> <td>1.000</td> <td>PZ</td> </tr> <tr> <td>0H8760A0</td> <td>PIASTRINA LAM SUPPORTO MICRO LIEV S</td> <td>1.000</td> <td>PZ</td> </tr> <tr> <td>0H8761A0</td> <td>PIASTRINA LAM SUPPORTO MICRO LIEV D</td> <td>1.000</td> <td>PZ</td> </tr> <tr> <td>CE1030A0</td> <td>FASTON FEMMINA 6.3X0.8 0,5-1mmq</td> <td>2.000</td> <td>PZ</td> </tr> <tr> <td>CE1660A0</td> <td>COPRI FASTON FEMMINA 6.3X0.8</td> <td>2.000</td> <td>PZ</td> </tr> <tr> <td>CE1730A0</td> <td>CAVO PVC NP 2 X AWG22 STYLE 2095</td> <td>1.400</td> <td>M</td> </tr> <tr> <td>CE1735A0</td> <td>TERMINALE MINIFIT FEMMINA</td> <td>2.000</td> <td>PZ</td> </tr> </tbody> </table>	Code	Description	Qty	UOM	0H8734A0	SCATOLA MICRO PORTA LIEVITATORE	1.000	PZ	0H8760A0	PIASTRINA LAM SUPPORTO MICRO LIEV S	1.000	PZ	0H8761A0	PIASTRINA LAM SUPPORTO MICRO LIEV D	1.000	PZ	CE1030A0	FASTON FEMMINA 6.3X0.8 0,5-1mmq	2.000	PZ	CE1660A0	COPRI FASTON FEMMINA 6.3X0.8	2.000	PZ	CE1730A0	CAVO PVC NP 2 X AWG22 STYLE 2095	1.400	M	CE1735A0	TERMINALE MINIFIT FEMMINA	2.000	PZ
Code	Description	Qty	UOM																															
0H8734A0	SCATOLA MICRO PORTA LIEVITATORE	1.000	PZ																															
0H8760A0	PIASTRINA LAM SUPPORTO MICRO LIEV S	1.000	PZ																															
0H8761A0	PIASTRINA LAM SUPPORTO MICRO LIEV D	1.000	PZ																															
CE1030A0	FASTON FEMMINA 6.3X0.8 0,5-1mmq	2.000	PZ																															
CE1660A0	COPRI FASTON FEMMINA 6.3X0.8	2.000	PZ																															
CE1730A0	CAVO PVC NP 2 X AWG22 STYLE 2095	1.400	M																															
CE1735A0	TERMINALE MINIFIT FEMMINA	2.000	PZ																															

COMPONENT			SPARE PART																																														
Code	Description	Image	Code	Description	Kit components																																												
RC1396A	TERMINALE DRITTO JG D10-1/4		K0H8734A	PROVER DOOR MICROSWITCH KIT	<table border="1"> <thead> <tr> <th>Code</th> <th>Description</th> <th>Qty</th> <th>UOM</th> </tr> </thead> <tbody> <tr> <td>CE1745A0</td> <td>CONNETTORE MINIFIT FEMMINA 2 VI</td> <td>1.000</td> <td>PZ</td> </tr> <tr> <td>RC1396A0</td> <td>TERMINALE DRITTO JG D10-1/4</td> <td>2.000</td> <td>PZ</td> </tr> <tr> <td>SL1044A0</td> <td>GRASSO SILICONICO AREXONS INCOLORE GS12</td> <td>0.100</td> <td>ML</td> </tr> <tr> <td>TB4722A0</td> <td>TB2243A-TUB O PE TRASP 600MM JG 10</td> <td>1.000</td> <td>PZ</td> </tr> <tr> <td>VE1295A0</td> <td>MICROINTERR UTTORE PORTA MK 16A 230V UL</td> <td>1.000</td> <td>PZ</td> </tr> <tr> <td>VI1220A1</td> <td>VITE AUTOFIL. 4.2X11 TCS+ MARUTEX</td> <td>2.000</td> <td>PZ</td> </tr> <tr> <td>VI1253A0</td> <td>DADO 1/4" H6 CH19 AISI 316</td> <td>1.000</td> <td>PZ</td> </tr> </tbody> </table>	Code	Description	Qty	UOM	CE1745A0	CONNETTORE MINIFIT FEMMINA 2 VI	1.000	PZ	RC1396A0	TERMINALE DRITTO JG D10-1/4	2.000	PZ	SL1044A0	GRASSO SILICONICO AREXONS INCOLORE GS12	0.100	ML	TB4722A0	TB2243A-TUB O PE TRASP 600MM JG 10	1.000	PZ	VE1295A0	MICROINTERR UTTORE PORTA MK 16A 230V UL	1.000	PZ	VI1220A1	VITE AUTOFIL. 4.2X11 TCS+ MARUTEX	2.000	PZ	VI1253A0	DADO 1/4" H6 CH19 AISI 316	1.000	PZ												
					Code	Description	Qty	UOM																																									
CE1745A0	CONNETTORE MINIFIT FEMMINA 2 VI	1.000	PZ																																														
RC1396A0	TERMINALE DRITTO JG D10-1/4	2.000	PZ																																														
SL1044A0	GRASSO SILICONICO AREXONS INCOLORE GS12	0.100	ML																																														
TB4722A0	TB2243A-TUB O PE TRASP 600MM JG 10	1.000	PZ																																														
VE1295A0	MICROINTERR UTTORE PORTA MK 16A 230V UL	1.000	PZ																																														
VI1220A1	VITE AUTOFIL. 4.2X11 TCS+ MARUTEX	2.000	PZ																																														
VI1253A0	DADO 1/4" H6 CH19 AISI 316	1.000	PZ																																														
VL1014B	RIDUTTORE DI PRESSIONE CON DISTRIBUTORE		KVL1465A	CB -X GN2/1 HOOD HYDRIC CIRCUIT KI	<table border="1"> <thead> <tr> <th>Code</th> <th>Description</th> <th>Qty</th> <th>UOM</th> </tr> </thead> <tbody> <tr> <td>0H8067A0</td> <td>LAMIERA SOSTEGNO EL CAPP A CBX</td> <td>1.000</td> <td>PZ</td> </tr> <tr> <td>EL1440A0</td> <td>ELETTROVALV OLA H2O AUTOPULENT E BAF EU</td> <td>2.000</td> <td>PZ</td> </tr> <tr> <td>GN1526A0</td> <td>O-RING D.INT6.9 SP1.8</td> <td>4.000</td> <td>PZ</td> </tr> <tr> <td>RC1018A0</td> <td>FASCETTA ELASTICA D12 ZINCATA</td> <td>12.000</td> <td>PZ</td> </tr> <tr> <td>RC1121A0</td> <td>RACCORDO Y D10-D10-10</td> <td>2.000</td> <td>PZ</td> </tr> <tr> <td>RC1243A0</td> <td>RACCORDO GOMITO CODOLO Ø10F-Ø10M</td> <td>1.000</td> <td>PZ</td> </tr> <tr> <td>RC1396A0</td> <td>TERMINALE DRITTO JG D10-1/4</td> <td>2.000</td> <td>PZ</td> </tr> <tr> <td>RC1414A1</td> <td>FASCETTA STRINGITUBO A SCATTO D11.5-12.5</td> <td>4.000</td> <td>PZ</td> </tr> <tr> <td>TB2867A0</td> <td>TB3132A-TUB O L75 MM</td> <td>8.000</td> <td>PZ</td> </tr> <tr> <td>VL1014B3</td> <td>RIDUTTORE DI PRESSIONE CON DISTRIBUTOR</td> <td>1.000</td> <td>PZ</td> </tr> </tbody> </table>	Code	Description	Qty	UOM	0H8067A0	LAMIERA SOSTEGNO EL CAPP A CBX	1.000	PZ	EL1440A0	ELETTROVALV OLA H2O AUTOPULENT E BAF EU	2.000	PZ	GN1526A0	O-RING D.INT6.9 SP1.8	4.000	PZ	RC1018A0	FASCETTA ELASTICA D12 ZINCATA	12.000	PZ	RC1121A0	RACCORDO Y D10-D10-10	2.000	PZ	RC1243A0	RACCORDO GOMITO CODOLO Ø10F-Ø10M	1.000	PZ	RC1396A0	TERMINALE DRITTO JG D10-1/4	2.000	PZ	RC1414A1	FASCETTA STRINGITUBO A SCATTO D11.5-12.5	4.000	PZ	TB2867A0	TB3132A-TUB O L75 MM	8.000	PZ	VL1014B3	RIDUTTORE DI PRESSIONE CON DISTRIBUTOR	1.000	PZ
					Code	Description	Qty	UOM																																									
					0H8067A0	LAMIERA SOSTEGNO EL CAPP A CBX	1.000	PZ																																									
					EL1440A0	ELETTROVALV OLA H2O AUTOPULENT E BAF EU	2.000	PZ																																									
					GN1526A0	O-RING D.INT6.9 SP1.8	4.000	PZ																																									
					RC1018A0	FASCETTA ELASTICA D12 ZINCATA	12.000	PZ																																									
					RC1121A0	RACCORDO Y D10-D10-10	2.000	PZ																																									
					RC1243A0	RACCORDO GOMITO CODOLO Ø10F-Ø10M	1.000	PZ																																									
					RC1396A0	TERMINALE DRITTO JG D10-1/4	2.000	PZ																																									
					RC1414A1	FASCETTA STRINGITUBO A SCATTO D11.5-12.5	4.000	PZ																																									
					TB2867A0	TB3132A-TUB O L75 MM	8.000	PZ																																									
					VL1014B3	RIDUTTORE DI PRESSIONE CON DISTRIBUTOR	1.000	PZ																																									

COMPONENT			SPARE PART																																							
Code	Description	Image	Code	Description	Kit components																																					
VL1014B	RIDUTTORE DI PRESSIONE CON DISTRIBUTORE		KVL1465A	CB -X GN2/1 HOOD HYDRIC CIRCUIT KI	<table border="1"> <thead> <tr> <th>Code</th> <th>Description</th> <th>Qty</th> <th>UOM</th> </tr> </thead> <tbody> <tr> <td>VL1095A0</td> <td>RACCORDO DRITTO M-M PORTAGOMM A D7.8-D10</td> <td>6.000</td> <td>PZ</td> </tr> <tr> <td>VL1165A0</td> <td>RACCORDO DRITTO BAM-BB6</td> <td>2.000</td> <td>PZ</td> </tr> <tr> <td>VL1166A0</td> <td>RACCORDO A L BAM-BB6</td> <td>2.000</td> <td>PZ</td> </tr> <tr> <td>VL1437A0</td> <td>DISTRIBUTOR E INGRESSI LAVAGGIO CAPPA CBX</td> <td>1.000</td> <td>PZ</td> </tr> <tr> <td>VM1054A0</td> <td>GHIERA RIDUTTORE DI PRESSIONE H7.8</td> <td>1.000</td> <td>PZ</td> </tr> <tr> <td>VM1605A0</td> <td>CLIP TWIST LOCK DIAM. 10,2-12,7 MM</td> <td>2.000</td> <td>PZ</td> </tr> <tr> <td>VM2652A0</td> <td>SELLA DI CABLAGGIO</td> <td>1.000</td> <td>PZ</td> </tr> </tbody> </table>	Code	Description	Qty	UOM	VL1095A0	RACCORDO DRITTO M-M PORTAGOMM A D7.8-D10	6.000	PZ	VL1165A0	RACCORDO DRITTO BAM-BB6	2.000	PZ	VL1166A0	RACCORDO A L BAM-BB6	2.000	PZ	VL1437A0	DISTRIBUTOR E INGRESSI LAVAGGIO CAPPA CBX	1.000	PZ	VM1054A0	GHIERA RIDUTTORE DI PRESSIONE H7.8	1.000	PZ	VM1605A0	CLIP TWIST LOCK DIAM. 10,2-12,7 MM	2.000	PZ	VM2652A0	SELLA DI CABLAGGIO	1.000	PZ					
			Code	Description	Qty	UOM																																				
VL1095A0	RACCORDO DRITTO M-M PORTAGOMM A D7.8-D10	6.000	PZ																																							
VL1165A0	RACCORDO DRITTO BAM-BB6	2.000	PZ																																							
VL1166A0	RACCORDO A L BAM-BB6	2.000	PZ																																							
VL1437A0	DISTRIBUTOR E INGRESSI LAVAGGIO CAPPA CBX	1.000	PZ																																							
VM1054A0	GHIERA RIDUTTORE DI PRESSIONE H7.8	1.000	PZ																																							
VM1605A0	CLIP TWIST LOCK DIAM. 10,2-12,7 MM	2.000	PZ																																							
VM2652A0	SELLA DI CABLAGGIO	1.000	PZ																																							
KVL1464A	BAKERTOP-X HOOD HYDRIC CIRCUIT KI	<table border="1"> <thead> <tr> <th>Code</th> <th>Description</th> <th>Qty</th> <th>UOM</th> </tr> </thead> <tbody> <tr> <td>0H8067A0</td> <td>LAMIERA SOSTEGNO EL CAPPA CBX</td> <td>1.000</td> <td>PZ</td> </tr> <tr> <td>EL1440A0</td> <td>ELETTROVALV OLA H2O AUTOPULENT E BAF EU</td> <td>2.000</td> <td>PZ</td> </tr> <tr> <td>GN1526A0</td> <td>O-RING D.INT6.9 SP1.8</td> <td>4.000</td> <td>PZ</td> </tr> <tr> <td>RC1018A0</td> <td>FASCETTA ELASTICA D12 ZINCATA</td> <td>4.000</td> <td>PZ</td> </tr> <tr> <td>RC1243A0</td> <td>RACCORDO GOMITO CODOLO Ø10F-Ø10M</td> <td>1.000</td> <td>PZ</td> </tr> <tr> <td>RC1396A0</td> <td>TERMINALE DRITTO JG D10-1/4</td> <td>2.000</td> <td>PZ</td> </tr> <tr> <td>RC1414A1</td> <td>FASCETTA STRINGITUBO A SCATTO D11.5-12.5</td> <td>4.000</td> <td>PZ</td> </tr> <tr> <td>TB2867A0</td> <td>TB3132A-TUB O L75 MM</td> <td>2.000</td> <td>PZ</td> </tr> <tr> <td>TB3246A0</td> <td>TB3132A-TUB O EPDM TELATO BIANCO-BLU 220M</td> <td>2.000</td> <td>PZ</td> </tr> </tbody> </table>	Code	Description	Qty	UOM	0H8067A0	LAMIERA SOSTEGNO EL CAPPA CBX	1.000	PZ	EL1440A0	ELETTROVALV OLA H2O AUTOPULENT E BAF EU	2.000	PZ	GN1526A0	O-RING D.INT6.9 SP1.8	4.000	PZ	RC1018A0	FASCETTA ELASTICA D12 ZINCATA	4.000	PZ	RC1243A0	RACCORDO GOMITO CODOLO Ø10F-Ø10M	1.000	PZ	RC1396A0	TERMINALE DRITTO JG D10-1/4	2.000	PZ	RC1414A1	FASCETTA STRINGITUBO A SCATTO D11.5-12.5	4.000	PZ	TB2867A0	TB3132A-TUB O L75 MM	2.000	PZ	TB3246A0	TB3132A-TUB O EPDM TELATO BIANCO-BLU 220M	2.000	PZ
Code	Description	Qty	UOM																																							
0H8067A0	LAMIERA SOSTEGNO EL CAPPA CBX	1.000	PZ																																							
EL1440A0	ELETTROVALV OLA H2O AUTOPULENT E BAF EU	2.000	PZ																																							
GN1526A0	O-RING D.INT6.9 SP1.8	4.000	PZ																																							
RC1018A0	FASCETTA ELASTICA D12 ZINCATA	4.000	PZ																																							
RC1243A0	RACCORDO GOMITO CODOLO Ø10F-Ø10M	1.000	PZ																																							
RC1396A0	TERMINALE DRITTO JG D10-1/4	2.000	PZ																																							
RC1414A1	FASCETTA STRINGITUBO A SCATTO D11.5-12.5	4.000	PZ																																							
TB2867A0	TB3132A-TUB O L75 MM	2.000	PZ																																							
TB3246A0	TB3132A-TUB O EPDM TELATO BIANCO-BLU 220M	2.000	PZ																																							

COMPONENT			SPARE PART																																							
Code	Description	Image	Code	Description	Kit components																																					
VL1014B	RIDUTTORE DI PRESSIONE CON DISTRIBUTORE		KVL1464A	BAKERTOP-X HOOD HYDRIC CIRCUIT KI	<table border="1"> <thead> <tr> <th>Code</th> <th>Description</th> <th>Qty</th> <th>UOM</th> </tr> </thead> <tbody> <tr> <td>VL1014B3</td> <td>RIDUTTORE DI PRESSIONE CON DISTRIBUTOR</td> <td>1.000</td> <td>PZ</td> </tr> <tr> <td>VL1165A0</td> <td>RACCORDO DRITTO BAM-BB6</td> <td>2.000</td> <td>PZ</td> </tr> <tr> <td>VL1166A0</td> <td>RACCORDO A L BAM-BB6</td> <td>2.000</td> <td>PZ</td> </tr> <tr> <td>VL1437A0</td> <td>DISTRIBUTOR E INGRESSI LAVAGGIO CAPP A CBX</td> <td>1.000</td> <td>PZ</td> </tr> <tr> <td>VM1054A0</td> <td>GHIERA RIDUTTORE DI PRESSIONE H7.8</td> <td>1.000</td> <td>PZ</td> </tr> <tr> <td>VM1605A0</td> <td>CLIP TWIST LOCK DIAM. 10,2-12,7 MM</td> <td>2.000</td> <td>PZ</td> </tr> <tr> <td>VM2652A0</td> <td>SELLA DI CABLAGGIO</td> <td>1.000</td> <td>PZ</td> </tr> </tbody> </table>	Code	Description	Qty	UOM	VL1014B3	RIDUTTORE DI PRESSIONE CON DISTRIBUTOR	1.000	PZ	VL1165A0	RACCORDO DRITTO BAM-BB6	2.000	PZ	VL1166A0	RACCORDO A L BAM-BB6	2.000	PZ	VL1437A0	DISTRIBUTOR E INGRESSI LAVAGGIO CAPP A CBX	1.000	PZ	VM1054A0	GHIERA RIDUTTORE DI PRESSIONE H7.8	1.000	PZ	VM1605A0	CLIP TWIST LOCK DIAM. 10,2-12,7 MM	2.000	PZ	VM2652A0	SELLA DI CABLAGGIO	1.000	PZ					
			Code	Description	Qty	UOM																																				
VL1014B3	RIDUTTORE DI PRESSIONE CON DISTRIBUTOR	1.000	PZ																																							
VL1165A0	RACCORDO DRITTO BAM-BB6	2.000	PZ																																							
VL1166A0	RACCORDO A L BAM-BB6	2.000	PZ																																							
VL1437A0	DISTRIBUTOR E INGRESSI LAVAGGIO CAPP A CBX	1.000	PZ																																							
VM1054A0	GHIERA RIDUTTORE DI PRESSIONE H7.8	1.000	PZ																																							
VM1605A0	CLIP TWIST LOCK DIAM. 10,2-12,7 MM	2.000	PZ																																							
VM2652A0	SELLA DI CABLAGGIO	1.000	PZ																																							
KVL1458A	CB -X HOOD HYDRIC SYSTEM KI	<table border="1"> <thead> <tr> <th>Code</th> <th>Description</th> <th>Qty</th> <th>UOM</th> </tr> </thead> <tbody> <tr> <td>0H8067A0</td> <td>LAMIERA SOSTEGNO EL CAPP A CBX</td> <td>1.000</td> <td>PZ</td> </tr> <tr> <td>EL1440A0</td> <td>ELETTROVALV OLA H2O AUTOPULENT E BAF EU</td> <td>2.000</td> <td>PZ</td> </tr> <tr> <td>GN1526A0</td> <td>O-RING D.INT6.9 SP1.8</td> <td>4.000</td> <td>PZ</td> </tr> <tr> <td>RC1018A0</td> <td>FASCETTA ELASTICA D12 ZINCATA</td> <td>4.000</td> <td>PZ</td> </tr> <tr> <td>RC1243A0</td> <td>RACCORDO GOMITO CODOLO Ø10F-Ø10M</td> <td>1.000</td> <td>PZ</td> </tr> <tr> <td>RC1396A0</td> <td>TERMINALE DRITTO JG D10-1/4</td> <td>2.000</td> <td>PZ</td> </tr> <tr> <td>RC1414A1</td> <td>FASCETTA STRINGITUBO A SCATTO D11.5-12.5</td> <td>4.000</td> <td>PZ</td> </tr> <tr> <td>TB1663A0</td> <td>TB3132-TUBO EPDM CONDENSATO RE SP 150MM</td> <td>2.000</td> <td>PZ</td> </tr> <tr> <td>TB2867A0</td> <td>TB3132A-TUB O L75 MM</td> <td>2.000</td> <td>PZ</td> </tr> </tbody> </table>	Code	Description	Qty	UOM	0H8067A0	LAMIERA SOSTEGNO EL CAPP A CBX	1.000	PZ	EL1440A0	ELETTROVALV OLA H2O AUTOPULENT E BAF EU	2.000	PZ	GN1526A0	O-RING D.INT6.9 SP1.8	4.000	PZ	RC1018A0	FASCETTA ELASTICA D12 ZINCATA	4.000	PZ	RC1243A0	RACCORDO GOMITO CODOLO Ø10F-Ø10M	1.000	PZ	RC1396A0	TERMINALE DRITTO JG D10-1/4	2.000	PZ	RC1414A1	FASCETTA STRINGITUBO A SCATTO D11.5-12.5	4.000	PZ	TB1663A0	TB3132-TUBO EPDM CONDENSATO RE SP 150MM	2.000	PZ	TB2867A0	TB3132A-TUB O L75 MM	2.000	PZ
Code	Description	Qty	UOM																																							
0H8067A0	LAMIERA SOSTEGNO EL CAPP A CBX	1.000	PZ																																							
EL1440A0	ELETTROVALV OLA H2O AUTOPULENT E BAF EU	2.000	PZ																																							
GN1526A0	O-RING D.INT6.9 SP1.8	4.000	PZ																																							
RC1018A0	FASCETTA ELASTICA D12 ZINCATA	4.000	PZ																																							
RC1243A0	RACCORDO GOMITO CODOLO Ø10F-Ø10M	1.000	PZ																																							
RC1396A0	TERMINALE DRITTO JG D10-1/4	2.000	PZ																																							
RC1414A1	FASCETTA STRINGITUBO A SCATTO D11.5-12.5	4.000	PZ																																							
TB1663A0	TB3132-TUBO EPDM CONDENSATO RE SP 150MM	2.000	PZ																																							
TB2867A0	TB3132A-TUB O L75 MM	2.000	PZ																																							

COMPONENT			SPARE PART																																		
Code	Description	Image	Code	Description	Kit components																																
VL1014B	RIDUTTORE DI PRESSIONE CON DISTRIBUTORE		KVL1458A	CB -X HOOD HYDRIC SYSTEM KI	<table border="1"> <thead> <tr> <th>Code</th> <th>Description</th> <th>Qty</th> <th>UOM</th> </tr> </thead> <tbody> <tr> <td>VL1014B3</td> <td>RIDUTTORE DI PRESSIONE CON DISTRIBUTOR</td> <td>1.000</td> <td>PZ</td> </tr> <tr> <td>VL1165A0</td> <td>RACCORDO DRITTO BAM-BB6</td> <td>2.000</td> <td>PZ</td> </tr> <tr> <td>VL1166A0</td> <td>RACCORDO A L BAM-BB6</td> <td>2.000</td> <td>PZ</td> </tr> <tr> <td>VL1437A0</td> <td>DISTRIBUTOR E INGRESSI LAVAGGIO CAPPA CBX</td> <td>1.000</td> <td>PZ</td> </tr> <tr> <td>VM1054A0</td> <td>GHIERA RIDUTTORE DI PRESSIONE H7.8</td> <td>1.000</td> <td>PZ</td> </tr> <tr> <td>VM1605A0</td> <td>CLIP TWIST LOCK DIAM. 10,2-12,7 MM</td> <td>2.000</td> <td>PZ</td> </tr> <tr> <td>VM2652A0</td> <td>SELLA DI CABLAGGIO</td> <td>1.000</td> <td>PZ</td> </tr> </tbody> </table>	Code	Description	Qty	UOM	VL1014B3	RIDUTTORE DI PRESSIONE CON DISTRIBUTOR	1.000	PZ	VL1165A0	RACCORDO DRITTO BAM-BB6	2.000	PZ	VL1166A0	RACCORDO A L BAM-BB6	2.000	PZ	VL1437A0	DISTRIBUTOR E INGRESSI LAVAGGIO CAPPA CBX	1.000	PZ	VM1054A0	GHIERA RIDUTTORE DI PRESSIONE H7.8	1.000	PZ	VM1605A0	CLIP TWIST LOCK DIAM. 10,2-12,7 MM	2.000	PZ	VM2652A0	SELLA DI CABLAGGIO	1.000	PZ
			Code	Description	Qty	UOM																															
			VL1014B3	RIDUTTORE DI PRESSIONE CON DISTRIBUTOR	1.000	PZ																															
VL1165A0	RACCORDO DRITTO BAM-BB6	2.000	PZ																																		
VL1166A0	RACCORDO A L BAM-BB6	2.000	PZ																																		
VL1437A0	DISTRIBUTOR E INGRESSI LAVAGGIO CAPPA CBX	1.000	PZ																																		
VM1054A0	GHIERA RIDUTTORE DI PRESSIONE H7.8	1.000	PZ																																		
VM1605A0	CLIP TWIST LOCK DIAM. 10,2-12,7 MM	2.000	PZ																																		
VM2652A0	SELLA DI CABLAGGIO	1.000	PZ																																		
KVL1435A	COMPACT/UNOX CASA PRESSURE REDUCER KIT	<table border="1"> <thead> <tr> <th>Code</th> <th>Description</th> <th>Qty</th> <th>UOM</th> </tr> </thead> <tbody> <tr> <td>0H8039A0</td> <td>LAMIERA SUPPORTO RIDUTTORE COMPACT MM</td> <td>1.000</td> <td>PZ</td> </tr> <tr> <td>RC1243A0</td> <td>RACCORDO GOMITO CODOLO Ø10F-Ø10M</td> <td>2.000</td> <td>PZ</td> </tr> <tr> <td>RC1396A0</td> <td>TERMINALE DRITTO JG D10-1/4</td> <td>2.000</td> <td>PZ</td> </tr> <tr> <td>VL1014B3</td> <td>RIDUTTORE DI PRESSIONE CON DISTRIBUTOR</td> <td>1.000</td> <td>PZ</td> </tr> <tr> <td>VM1054A0</td> <td>GHIERA RIDUTTORE DI PRESSIONE H7.8</td> <td>1.000</td> <td>PZ</td> </tr> </tbody> </table>	Code	Description	Qty	UOM	0H8039A0	LAMIERA SUPPORTO RIDUTTORE COMPACT MM	1.000	PZ	RC1243A0	RACCORDO GOMITO CODOLO Ø10F-Ø10M	2.000	PZ	RC1396A0	TERMINALE DRITTO JG D10-1/4	2.000	PZ	VL1014B3	RIDUTTORE DI PRESSIONE CON DISTRIBUTOR	1.000	PZ	VM1054A0	GHIERA RIDUTTORE DI PRESSIONE H7.8	1.000	PZ											
Code	Description	Qty	UOM																																		
0H8039A0	LAMIERA SUPPORTO RIDUTTORE COMPACT MM	1.000	PZ																																		
RC1243A0	RACCORDO GOMITO CODOLO Ø10F-Ø10M	2.000	PZ																																		
RC1396A0	TERMINALE DRITTO JG D10-1/4	2.000	PZ																																		
VL1014B3	RIDUTTORE DI PRESSIONE CON DISTRIBUTOR	1.000	PZ																																		
VM1054A0	GHIERA RIDUTTORE DI PRESSIONE H7.8	1.000	PZ																																		
KVL1413A	EU SPEED-X HOOD WASHING KIT	<table border="1"> <thead> <tr> <th>Code</th> <th>Description</th> <th>Qty</th> <th>UOM</th> </tr> </thead> <tbody> <tr> <td>0H2514A1</td> <td>LAMIERA SOSTEGNO EL1440</td> <td>1.000</td> <td>PZ</td> </tr> <tr> <td>0H5472A0</td> <td>PORTA COMPONENTI CAPPA SPEED.X</td> <td>1.000</td> <td>PZ</td> </tr> </tbody> </table>	Code	Description	Qty	UOM	0H2514A1	LAMIERA SOSTEGNO EL1440	1.000	PZ	0H5472A0	PORTA COMPONENTI CAPPA SPEED.X	1.000	PZ																							
Code	Description	Qty	UOM																																		
0H2514A1	LAMIERA SOSTEGNO EL1440	1.000	PZ																																		
0H5472A0	PORTA COMPONENTI CAPPA SPEED.X	1.000	PZ																																		

COMPONENT			SPARE PART																																																																																									
Code	Description	Image	Code	Description	Kit components																																																																																							
VL1014B	RIDUTTORE DI PRESSIONE CON DISTRIBUTORE		KVL1413A	EU SPEED-X HOOD WASHING KIT	<table border="1"> <thead> <tr> <th>Code</th> <th>Description</th> <th>Qty</th> <th>UOM</th> </tr> </thead> <tbody> <tr> <td>EL1440A0</td> <td>ELETTROVALV OLA H2O AUTOPULENT E BAF EU</td> <td>1.000</td> <td>PZ</td> </tr> <tr> <td>GN1526A0</td> <td>O-RING D.INT6,9 SP1.8</td> <td>2.000</td> <td>PZ</td> </tr> <tr> <td>RC1018A0</td> <td>FASCETTA ELASTICA D12 ZINCATA</td> <td>4.000</td> <td>PZ</td> </tr> <tr> <td>RC1243A0</td> <td>RACCORDO GOMITO CODOLO Ø10F-Ø10M</td> <td>1.000</td> <td>PZ</td> </tr> <tr> <td>RC1396A0</td> <td>TERMINALE DRITTO JG D10-1/4</td> <td>2.000</td> <td>PZ</td> </tr> <tr> <td>TB3252A0</td> <td>TB3132A-L=23 0MM EPDM BIANCO BLU</td> <td>1.000</td> <td>PZ</td> </tr> <tr> <td>TB3426A0</td> <td>TB3132A-TUB O EPDM BIANCO BLU L90</td> <td>1.000</td> <td>PZ</td> </tr> <tr> <td>VI1220A1</td> <td>VITE AUTOFIL. 4.2X11 TCS+ MARUTEX</td> <td>2.000</td> <td>PZ</td> </tr> <tr> <td>VL1014B3</td> <td>RIDUTTORE DI PRESSIONE CON DISTRIBUTOR</td> <td></td> <td></td> <td>1.000</td> <td>PZ</td> </tr> <tr> <td>VL1095A0</td> <td>RACCORDO DRITTO M-M PORTAGOMM A D7,8-D10</td> <td></td> <td></td> <td>1.000</td> <td>PZ</td> </tr> <tr> <td>VL1165A0</td> <td>RACCORDO DRITTO BAM-BB6</td> <td></td> <td></td> <td>2.000</td> <td>PZ</td> </tr> <tr> <td>VM1054A0</td> <td>GHIERA RIDUTTORE DI PRESSIONE H7,8</td> <td></td> <td></td> <td>1.000</td> <td>PZ</td> </tr> <tr> <td>VM1605A0</td> <td>CLIP TWIST LOCK DIAM. 10,2-12,7 MM</td> <td></td> <td></td> <td>1.000</td> <td>PZ</td> </tr> <tr> <td>VM2652A0</td> <td>SELLA DI CABLAGGIO</td> <td></td> <td></td> <td>1.000</td> <td>PZ</td> </tr> </tbody> </table>	Code	Description	Qty	UOM	EL1440A0	ELETTROVALV OLA H2O AUTOPULENT E BAF EU	1.000	PZ	GN1526A0	O-RING D.INT6,9 SP1.8	2.000	PZ	RC1018A0	FASCETTA ELASTICA D12 ZINCATA	4.000	PZ	RC1243A0	RACCORDO GOMITO CODOLO Ø10F-Ø10M	1.000	PZ	RC1396A0	TERMINALE DRITTO JG D10-1/4	2.000	PZ	TB3252A0	TB3132A-L=23 0MM EPDM BIANCO BLU	1.000	PZ	TB3426A0	TB3132A-TUB O EPDM BIANCO BLU L90	1.000	PZ	VI1220A1	VITE AUTOFIL. 4.2X11 TCS+ MARUTEX	2.000	PZ	VL1014B3	RIDUTTORE DI PRESSIONE CON DISTRIBUTOR			1.000	PZ	VL1095A0	RACCORDO DRITTO M-M PORTAGOMM A D7,8-D10			1.000	PZ	VL1165A0	RACCORDO DRITTO BAM-BB6			2.000	PZ	VM1054A0	GHIERA RIDUTTORE DI PRESSIONE H7,8			1.000	PZ	VM1605A0	CLIP TWIST LOCK DIAM. 10,2-12,7 MM			1.000	PZ	VM2652A0	SELLA DI CABLAGGIO			1.000	PZ	KVL1163A	MIND.Maps INLET CONNECTING PIPE KIT	<table border="1"> <thead> <tr> <th>Code</th> <th>Description</th> <th>Qty</th> <th>UOM</th> </tr> </thead> <tbody> <tr> <td>0H8038A0</td> <td>LAMIERA SUPPORTO RIDUTTORE M</td> <td>1.000</td> <td>PZ</td> </tr> <tr> <td>0H8039A0</td> <td>LAMIERA SUPPORTO RIDUTTORE COMPACT MM</td> <td>1.000</td> <td>PZ</td> </tr> </tbody> </table>	Code	Description	Qty	UOM	0H8038A0	LAMIERA SUPPORTO RIDUTTORE M	1.000	PZ	0H8039A0	LAMIERA SUPPORTO RIDUTTORE COMPACT MM	1.000	PZ
			Code	Description	Qty	UOM																																																																																						
EL1440A0	ELETTROVALV OLA H2O AUTOPULENT E BAF EU	1.000	PZ																																																																																									
GN1526A0	O-RING D.INT6,9 SP1.8	2.000	PZ																																																																																									
RC1018A0	FASCETTA ELASTICA D12 ZINCATA	4.000	PZ																																																																																									
RC1243A0	RACCORDO GOMITO CODOLO Ø10F-Ø10M	1.000	PZ																																																																																									
RC1396A0	TERMINALE DRITTO JG D10-1/4	2.000	PZ																																																																																									
TB3252A0	TB3132A-L=23 0MM EPDM BIANCO BLU	1.000	PZ																																																																																									
TB3426A0	TB3132A-TUB O EPDM BIANCO BLU L90	1.000	PZ																																																																																									
VI1220A1	VITE AUTOFIL. 4.2X11 TCS+ MARUTEX	2.000	PZ																																																																																									
VL1014B3	RIDUTTORE DI PRESSIONE CON DISTRIBUTOR			1.000	PZ																																																																																							
VL1095A0	RACCORDO DRITTO M-M PORTAGOMM A D7,8-D10			1.000	PZ																																																																																							
VL1165A0	RACCORDO DRITTO BAM-BB6			2.000	PZ																																																																																							
VM1054A0	GHIERA RIDUTTORE DI PRESSIONE H7,8			1.000	PZ																																																																																							
VM1605A0	CLIP TWIST LOCK DIAM. 10,2-12,7 MM			1.000	PZ																																																																																							
VM2652A0	SELLA DI CABLAGGIO			1.000	PZ																																																																																							
Code	Description	Qty	UOM																																																																																									
0H8038A0	LAMIERA SUPPORTO RIDUTTORE M	1.000	PZ																																																																																									
0H8039A0	LAMIERA SUPPORTO RIDUTTORE COMPACT MM	1.000	PZ																																																																																									

COMPONENT			SPARE PART																																										
Code	Description	Image	Code	Description	Kit components																																								
VL1014B	RIDUTTORE DI PRESSIONE CON DISTRIBUTORE		KVL1163A	MIND.Maps INLET CONNECTING PIPE KIT	<table border="1"> <thead> <tr> <th>Code</th> <th>Description</th> <th>Qty</th> <th>UOM</th> </tr> </thead> <tbody> <tr> <td>CH1026A0</td> <td>CHIAVE J.G. UNOX D8-D10</td> <td>1.000</td> <td>PZ</td> </tr> <tr> <td>RC1243A0</td> <td>RACCORDO GOMITO CODOLO Ø10F-Ø10M</td> <td>2.000</td> <td>PZ</td> </tr> <tr> <td>RC1396A0</td> <td>TERMINALE DRITTO JG D10-1/4</td> <td>2.000</td> <td>PZ</td> </tr> <tr> <td>TB2243A0</td> <td>TUBO D10 PE TRASPARENT</td> <td>0.050</td> <td>M</td> </tr> <tr> <td>VI1220A1</td> <td>VITE AUTOFIL. 4.2X11 TCS+ MARUTEX</td> <td>2.000</td> <td>PZ</td> </tr> <tr> <td>VI1950A0</td> <td>VITE AUTOFORANT E 4,2X13 TCB INOX</td> <td>1.000</td> <td>PZ</td> </tr> <tr> <td>VL1014B3</td> <td>RIDUTTORE DI PRESSIONE CON DISTRIBUTOR</td> <td>1.000</td> <td>PZ</td> </tr> <tr> <td>VL1135A1</td> <td>RACCORDO 3/4-JG10 CON FILTRO E VNR</td> <td>1.000</td> <td>PZ</td> </tr> <tr> <td>VM1054A0</td> <td>GHIERA RIDUTTORE DI PRESSIONE H7.8</td> <td>1.000</td> <td>PZ</td> </tr> </tbody> </table>	Code	Description	Qty	UOM	CH1026A0	CHIAVE J.G. UNOX D8-D10	1.000	PZ	RC1243A0	RACCORDO GOMITO CODOLO Ø10F-Ø10M	2.000	PZ	RC1396A0	TERMINALE DRITTO JG D10-1/4	2.000	PZ	TB2243A0	TUBO D10 PE TRASPARENT	0.050	M	VI1220A1	VITE AUTOFIL. 4.2X11 TCS+ MARUTEX	2.000	PZ	VI1950A0	VITE AUTOFORANT E 4,2X13 TCB INOX	1.000	PZ	VL1014B3	RIDUTTORE DI PRESSIONE CON DISTRIBUTOR	1.000	PZ	VL1135A1	RACCORDO 3/4-JG10 CON FILTRO E VNR	1.000	PZ	VM1054A0	GHIERA RIDUTTORE DI PRESSIONE H7.8	1.000	PZ
			Code	Description	Qty	UOM																																							
			CH1026A0	CHIAVE J.G. UNOX D8-D10	1.000	PZ																																							
RC1243A0	RACCORDO GOMITO CODOLO Ø10F-Ø10M	2.000	PZ																																										
RC1396A0	TERMINALE DRITTO JG D10-1/4	2.000	PZ																																										
TB2243A0	TUBO D10 PE TRASPARENT	0.050	M																																										
VI1220A1	VITE AUTOFIL. 4.2X11 TCS+ MARUTEX	2.000	PZ																																										
VI1950A0	VITE AUTOFORANT E 4,2X13 TCB INOX	1.000	PZ																																										
VL1014B3	RIDUTTORE DI PRESSIONE CON DISTRIBUTOR	1.000	PZ																																										
VL1135A1	RACCORDO 3/4-JG10 CON FILTRO E VNR	1.000	PZ																																										
VM1054A0	GHIERA RIDUTTORE DI PRESSIONE H7.8	1.000	PZ																																										
KVL0020A	PRESS.REDUCER 03-05XX≥OCT18/MM -LUX≥MAR19	<table border="1"> <thead> <tr> <th>Code</th> <th>Description</th> <th>Qty</th> <th>UOM</th> </tr> </thead> <tbody> <tr> <td>RC1396A0</td> <td>TERMINALE DRITTO JG D10-1/4</td> <td>2.000</td> <td>PZ</td> </tr> <tr> <td>VL1014B3</td> <td>RIDUTTORE DI PRESSIONE CON DISTRIBUTOR</td> <td>1.000</td> <td>PZ</td> </tr> <tr> <td>VM1054A0</td> <td>GHIERA RIDUTTORE DI PRESSIONE H7.8</td> <td>1.000</td> <td>PZ</td> </tr> </tbody> </table>	Code	Description	Qty	UOM	RC1396A0	TERMINALE DRITTO JG D10-1/4	2.000	PZ	VL1014B3	RIDUTTORE DI PRESSIONE CON DISTRIBUTOR	1.000	PZ	VM1054A0	GHIERA RIDUTTORE DI PRESSIONE H7.8	1.000	PZ																											
Code	Description	Qty	UOM																																										
RC1396A0	TERMINALE DRITTO JG D10-1/4	2.000	PZ																																										
VL1014B3	RIDUTTORE DI PRESSIONE CON DISTRIBUTOR	1.000	PZ																																										
VM1054A0	GHIERA RIDUTTORE DI PRESSIONE H7.8	1.000	PZ																																										
KVL0014B	MIND.MAPS 2017-2018 PRESSURE REDUCER KIT	<table border="1"> <thead> <tr> <th>Code</th> <th>Description</th> <th>Qty</th> <th>UOM</th> </tr> </thead> <tbody> <tr> <td>RC1372A0</td> <td>RACCORDO DRITTO Ø10M-1/4 M CI</td> <td>1.000</td> <td>PZ</td> </tr> <tr> <td>RC1396A0</td> <td>TERMINALE DRITTO JG D10-1/4</td> <td>1.000</td> <td>PZ</td> </tr> <tr> <td>VL1014B3</td> <td>RIDUTTORE DI PRESSIONE CON DISTRIBUTOR</td> <td>1.000</td> <td>PZ</td> </tr> <tr> <td>VM1054A0</td> <td>GHIERA RIDUTTORE DI PRESSIONE H7.8</td> <td>1.000</td> <td>PZ</td> </tr> </tbody> </table>	Code	Description	Qty	UOM	RC1372A0	RACCORDO DRITTO Ø10M-1/4 M CI	1.000	PZ	RC1396A0	TERMINALE DRITTO JG D10-1/4	1.000	PZ	VL1014B3	RIDUTTORE DI PRESSIONE CON DISTRIBUTOR	1.000	PZ	VM1054A0	GHIERA RIDUTTORE DI PRESSIONE H7.8	1.000	PZ																							
Code	Description	Qty	UOM																																										
RC1372A0	RACCORDO DRITTO Ø10M-1/4 M CI	1.000	PZ																																										
RC1396A0	TERMINALE DRITTO JG D10-1/4	1.000	PZ																																										
VL1014B3	RIDUTTORE DI PRESSIONE CON DISTRIBUTOR	1.000	PZ																																										
VM1054A0	GHIERA RIDUTTORE DI PRESSIONE H7.8	1.000	PZ																																										

COMPONENT			SPARE PART																																			
Code	Description	Image	Code	Description	Kit components																																	
VL1014B	RIDUTTORE DI PRESSIONE CON DISTRIBUTORE		KVL0014A	MM ≤2016 / LUX<2019 PRESSURE REDUCER KIT	<table border="1"> <thead> <tr> <th>Code</th> <th>Description</th> <th>Qty</th> <th>UOM</th> </tr> </thead> <tbody> <tr> <td>RC1372A0</td> <td>RACCORDO DRITTO Ø10M-1/4 M CI</td> <td>2.000</td> <td>PZ</td> </tr> <tr> <td>VL1014B3</td> <td>RIDUTTORE DI PRESSIONE CON DISTRIBUTOR</td> <td>1.000</td> <td>PZ</td> </tr> <tr> <td>VM1054A0</td> <td>GHIERA RIDUTTORE DI PRESSIONE H7.8</td> <td>1.000</td> <td>PZ</td> </tr> </tbody> </table>	Code	Description	Qty	UOM	RC1372A0	RACCORDO DRITTO Ø10M-1/4 M CI	2.000	PZ	VL1014B3	RIDUTTORE DI PRESSIONE CON DISTRIBUTOR	1.000	PZ	VM1054A0	GHIERA RIDUTTORE DI PRESSIONE H7.8	1.000	PZ																	
			Code	Description	Qty	UOM																																
RC1372A0	RACCORDO DRITTO Ø10M-1/4 M CI	2.000	PZ																																			
VL1014B3	RIDUTTORE DI PRESSIONE CON DISTRIBUTOR	1.000	PZ																																			
VM1054A0	GHIERA RIDUTTORE DI PRESSIONE H7.8	1.000	PZ																																			
KVL0010A	S.4 - 5 WATER PRESSURE REDUCER KIT	<table border="1"> <thead> <tr> <th>Code</th> <th>Description</th> <th>Qty</th> <th>UOM</th> </tr> </thead> <tbody> <tr> <td>EL1210A0</td> <td>RACCORDO DRITTO D8-BSP1/4 JG</td> <td>2.000</td> <td>PZ</td> </tr> <tr> <td>VL1014B3</td> <td>RIDUTTORE DI PRESSIONE CON DISTRIBUTOR</td> <td>1.000</td> <td>PZ</td> </tr> </tbody> </table>	Code	Description	Qty	UOM	EL1210A0	RACCORDO DRITTO D8-BSP1/4 JG	2.000	PZ	VL1014B3	RIDUTTORE DI PRESSIONE CON DISTRIBUTOR	1.000	PZ																								
Code	Description	Qty	UOM																																			
EL1210A0	RACCORDO DRITTO D8-BSP1/4 JG	2.000	PZ																																			
VL1014B3	RIDUTTORE DI PRESSIONE CON DISTRIBUTOR	1.000	PZ																																			
VM1054A	GHIERA RIDUTTORE DI PRESSIONE H7.8		KVM1054A	H7.8 PRESSURE REDUCER DIAL KIT	<table border="1"> <thead> <tr> <th>Code</th> <th>Description</th> <th>Qty</th> <th>UOM</th> </tr> </thead> <tbody> <tr> <td>VM1054A0</td> <td>GHIERA RIDUTTORE DI PRESSIONE H7.8</td> <td>1.000</td> <td>PZ</td> </tr> </tbody> </table>	Code	Description	Qty	UOM	VM1054A0	GHIERA RIDUTTORE DI PRESSIONE H7.8	1.000	PZ																									
			Code	Description	Qty	UOM																																
VM1054A0	GHIERA RIDUTTORE DI PRESSIONE H7.8	1.000	PZ																																			
KVL1465A	CB -X GN2/1 HOOD HYDRIC CIRCUIT KI	<table border="1"> <thead> <tr> <th>Code</th> <th>Description</th> <th>Qty</th> <th>UOM</th> </tr> </thead> <tbody> <tr> <td>0H8067A0</td> <td>LAMIERA SOSTEGNO EL CAPP A CBX</td> <td>1.000</td> <td>PZ</td> </tr> <tr> <td>EL1440A0</td> <td>ELETTROVALV OLA H2O AUTOPULENT E BAF EU</td> <td>2.000</td> <td>PZ</td> </tr> <tr> <td>GN1526A0</td> <td>O-RING D.INT6.9 SP1.8</td> <td>4.000</td> <td>PZ</td> </tr> <tr> <td>RC1018A0</td> <td>FASCETTA ELASTICA D12 ZINCATA</td> <td>12.000</td> <td>PZ</td> </tr> <tr> <td>RC1121A0</td> <td>RACCORDO Y D10-D10-10</td> <td>2.000</td> <td>PZ</td> </tr> <tr> <td>RC1243A0</td> <td>RACCORDO GOMITO CODOLO Ø10F-Ø10M</td> <td>1.000</td> <td>PZ</td> </tr> <tr> <td>RC1396A0</td> <td>TERMINALE DRITTO JG D10-1/4</td> <td>2.000</td> <td>PZ</td> </tr> <tr> <td>RC1414A1</td> <td>FASCETTA STRINGITUBO A SCATTO D11.5-12.5</td> <td>4.000</td> <td>PZ</td> </tr> </tbody> </table>	Code	Description	Qty	UOM	0H8067A0	LAMIERA SOSTEGNO EL CAPP A CBX	1.000	PZ	EL1440A0	ELETTROVALV OLA H2O AUTOPULENT E BAF EU	2.000	PZ	GN1526A0	O-RING D.INT6.9 SP1.8	4.000	PZ	RC1018A0	FASCETTA ELASTICA D12 ZINCATA	12.000	PZ	RC1121A0	RACCORDO Y D10-D10-10	2.000	PZ	RC1243A0	RACCORDO GOMITO CODOLO Ø10F-Ø10M	1.000	PZ	RC1396A0	TERMINALE DRITTO JG D10-1/4	2.000	PZ	RC1414A1	FASCETTA STRINGITUBO A SCATTO D11.5-12.5	4.000	PZ
Code	Description	Qty	UOM																																			
0H8067A0	LAMIERA SOSTEGNO EL CAPP A CBX	1.000	PZ																																			
EL1440A0	ELETTROVALV OLA H2O AUTOPULENT E BAF EU	2.000	PZ																																			
GN1526A0	O-RING D.INT6.9 SP1.8	4.000	PZ																																			
RC1018A0	FASCETTA ELASTICA D12 ZINCATA	12.000	PZ																																			
RC1121A0	RACCORDO Y D10-D10-10	2.000	PZ																																			
RC1243A0	RACCORDO GOMITO CODOLO Ø10F-Ø10M	1.000	PZ																																			
RC1396A0	TERMINALE DRITTO JG D10-1/4	2.000	PZ																																			
RC1414A1	FASCETTA STRINGITUBO A SCATTO D11.5-12.5	4.000	PZ																																			

COMPONENT			SPARE PART																																																																																	
Code	Description	Image	Code	Description	Kit components																																																																															
VM1054A	GHIERA RIDUTTORE DI PRESSIONE H7.8		KVL1465A	CB -X GN2/1 HOOD HYDRIC CIRCUIT KI	<table border="1"> <thead> <tr> <th>Code</th> <th>Description</th> <th>Qty</th> <th>UOM</th> </tr> </thead> <tbody> <tr> <td>TB2867A0</td> <td>TB3132A-TUB O L75 MM</td> <td>8.000</td> <td>PZ</td> </tr> <tr> <td>VL1014B3</td> <td>RIDUTTORE DI PRESSIONE CON DISTRIBUTOR</td> <td>1.000</td> <td>PZ</td> </tr> <tr> <td>VL1095A0</td> <td>RACCORDO DRITTO M-M PORTAGOMM A D7.8-D10</td> <td>6.000</td> <td>PZ</td> </tr> <tr> <td>VL1165A0</td> <td>RACCORDO DRITTO BAM-BB6</td> <td>2.000</td> <td>PZ</td> </tr> <tr> <td>VL1166A0</td> <td>RACCORDO A L BAM-BB6</td> <td>2.000</td> <td>PZ</td> </tr> <tr> <td>VL1437A0</td> <td>DISTRIBUTOR E INGRESSI LAVAGGIO CAPP A CBX</td> <td>1.000</td> <td>PZ</td> </tr> <tr> <td>VM1054A0</td> <td>GHIERA RIDUTTORE DI PRESSIONE H7.8</td> <td>1.000</td> <td>PZ</td> </tr> <tr> <td>VM1605A0</td> <td>CLIP TWIST LOCK DIAM. 10,2-12,7 MM</td> <td>2.000</td> <td>PZ</td> </tr> <tr> <td>VM2652A0</td> <td>SELLA DI CABLAGGIO</td> <td>1.000</td> <td>PZ</td> </tr> </tbody> </table>	Code	Description	Qty	UOM	TB2867A0	TB3132A-TUB O L75 MM	8.000	PZ	VL1014B3	RIDUTTORE DI PRESSIONE CON DISTRIBUTOR	1.000	PZ	VL1095A0	RACCORDO DRITTO M-M PORTAGOMM A D7.8-D10	6.000	PZ	VL1165A0	RACCORDO DRITTO BAM-BB6	2.000	PZ	VL1166A0	RACCORDO A L BAM-BB6	2.000	PZ	VL1437A0	DISTRIBUTOR E INGRESSI LAVAGGIO CAPP A CBX	1.000	PZ	VM1054A0	GHIERA RIDUTTORE DI PRESSIONE H7.8	1.000	PZ	VM1605A0	CLIP TWIST LOCK DIAM. 10,2-12,7 MM	2.000	PZ	VM2652A0	SELLA DI CABLAGGIO	1.000	PZ	KVL1464A	BAKERTOP-X HOOD HYDRIC CIRCUIT KI	<table border="1"> <thead> <tr> <th>Code</th> <th>Description</th> <th>Qty</th> <th>UOM</th> </tr> </thead> <tbody> <tr> <td>0H8067A0</td> <td>LAMIERA SOSTEGNO EL CAPP A CBX</td> <td>1.000</td> <td>PZ</td> </tr> <tr> <td>EL1440A0</td> <td>ELETTROVALV OLA H2O AUTOPULENT E BAF EU</td> <td>2.000</td> <td>PZ</td> </tr> <tr> <td>GN1526A0</td> <td>O-RING D.INT6.9 SP1.8</td> <td>4.000</td> <td>PZ</td> </tr> <tr> <td>RC1018A0</td> <td>FASCETTA ELASTICA D12 ZINCATA</td> <td>4.000</td> <td>PZ</td> </tr> <tr> <td>RC1243A0</td> <td>RACCORDO GOMITO CODOLO Ø10F-Ø10M</td> <td>1.000</td> <td>PZ</td> </tr> <tr> <td>RC1396A0</td> <td>TERMINALE DRITTO JG D10-1/4</td> <td>2.000</td> <td>PZ</td> </tr> <tr> <td>RC1414A1</td> <td>FASCETTA STRINGITUBO A SCATTO D11.5-12.5</td> <td>4.000</td> <td>PZ</td> </tr> <tr> <td>TB2867A0</td> <td>TB3132A-TUB O L75 MM</td> <td>2.000</td> <td>PZ</td> </tr> </tbody> </table>	Code	Description	Qty	UOM	0H8067A0	LAMIERA SOSTEGNO EL CAPP A CBX	1.000	PZ	EL1440A0	ELETTROVALV OLA H2O AUTOPULENT E BAF EU	2.000	PZ	GN1526A0	O-RING D.INT6.9 SP1.8	4.000	PZ	RC1018A0	FASCETTA ELASTICA D12 ZINCATA	4.000	PZ	RC1243A0	RACCORDO GOMITO CODOLO Ø10F-Ø10M	1.000	PZ	RC1396A0	TERMINALE DRITTO JG D10-1/4	2.000	PZ	RC1414A1	FASCETTA STRINGITUBO A SCATTO D11.5-12.5	4.000	PZ	TB2867A0	TB3132A-TUB O L75 MM	2.000	PZ
			Code		Description	Qty	UOM																																																																													
TB2867A0	TB3132A-TUB O L75 MM	8.000	PZ																																																																																	
VL1014B3	RIDUTTORE DI PRESSIONE CON DISTRIBUTOR	1.000	PZ																																																																																	
VL1095A0	RACCORDO DRITTO M-M PORTAGOMM A D7.8-D10	6.000	PZ																																																																																	
VL1165A0	RACCORDO DRITTO BAM-BB6	2.000	PZ																																																																																	
VL1166A0	RACCORDO A L BAM-BB6	2.000	PZ																																																																																	
VL1437A0	DISTRIBUTOR E INGRESSI LAVAGGIO CAPP A CBX	1.000	PZ																																																																																	
VM1054A0	GHIERA RIDUTTORE DI PRESSIONE H7.8	1.000	PZ																																																																																	
VM1605A0	CLIP TWIST LOCK DIAM. 10,2-12,7 MM	2.000	PZ																																																																																	
VM2652A0	SELLA DI CABLAGGIO	1.000	PZ																																																																																	
Code	Description	Qty	UOM																																																																																	
0H8067A0	LAMIERA SOSTEGNO EL CAPP A CBX	1.000	PZ																																																																																	
EL1440A0	ELETTROVALV OLA H2O AUTOPULENT E BAF EU	2.000	PZ																																																																																	
GN1526A0	O-RING D.INT6.9 SP1.8	4.000	PZ																																																																																	
RC1018A0	FASCETTA ELASTICA D12 ZINCATA	4.000	PZ																																																																																	
RC1243A0	RACCORDO GOMITO CODOLO Ø10F-Ø10M	1.000	PZ																																																																																	
RC1396A0	TERMINALE DRITTO JG D10-1/4	2.000	PZ																																																																																	
RC1414A1	FASCETTA STRINGITUBO A SCATTO D11.5-12.5	4.000	PZ																																																																																	
TB2867A0	TB3132A-TUB O L75 MM	2.000	PZ																																																																																	

COMPONENT			SPARE PART																																						
Code	Description	Image	Code	Description	Kit components																																				
VM1054A	GHIERA RIDUTTORE DI PRESSIONE H7.8		KVL1464A	BAKERTOP-X HOOD HYDRIC CIRCUIT KI	<table border="1"> <thead> <tr> <th>Code</th> <th>Description</th> <th>Qty</th> <th>UOM</th> </tr> </thead> <tbody> <tr> <td>TB3246A0</td> <td>TB3132A-TUB O EPDM TELATO BIANCO-BLU 220M</td> <td>2.000</td> <td>PZ</td> </tr> <tr> <td>VL1014B3</td> <td>RIDUTTORE DI PRESSIONE CON DISTRIBUTOR</td> <td>1.000</td> <td>PZ</td> </tr> <tr> <td>VL1165A0</td> <td>RACCORDO DRITTO BAM-BB6</td> <td>2.000</td> <td>PZ</td> </tr> <tr> <td>VL1166A0</td> <td>RACCORDO A L BAM-BB6</td> <td>2.000</td> <td>PZ</td> </tr> <tr> <td>VL1437A0</td> <td>DISTRIBUTOR E INGRESSI LAVAGGIO CAPPA CBX</td> <td>1.000</td> <td>PZ</td> </tr> <tr> <td>VM1054A0</td> <td>GHIERA RIDUTTORE DI PRESSIONE H7.8</td> <td>1.000</td> <td>PZ</td> </tr> <tr> <td>VM1605A0</td> <td>CLIP TWIST LOCK DIAM. 10,2-12,7 MM</td> <td>2.000</td> <td>PZ</td> </tr> <tr> <td>VM2652A0</td> <td>SELLA DI CABLAGGIO</td> <td>1.000</td> <td>PZ</td> </tr> </tbody> </table>	Code	Description	Qty	UOM	TB3246A0	TB3132A-TUB O EPDM TELATO BIANCO-BLU 220M	2.000	PZ	VL1014B3	RIDUTTORE DI PRESSIONE CON DISTRIBUTOR	1.000	PZ	VL1165A0	RACCORDO DRITTO BAM-BB6	2.000	PZ	VL1166A0	RACCORDO A L BAM-BB6	2.000	PZ	VL1437A0	DISTRIBUTOR E INGRESSI LAVAGGIO CAPPA CBX	1.000	PZ	VM1054A0	GHIERA RIDUTTORE DI PRESSIONE H7.8	1.000	PZ	VM1605A0	CLIP TWIST LOCK DIAM. 10,2-12,7 MM	2.000	PZ	VM2652A0	SELLA DI CABLAGGIO	1.000	PZ
			Code	Description	Qty	UOM																																			
TB3246A0	TB3132A-TUB O EPDM TELATO BIANCO-BLU 220M	2.000	PZ																																						
VL1014B3	RIDUTTORE DI PRESSIONE CON DISTRIBUTOR	1.000	PZ																																						
VL1165A0	RACCORDO DRITTO BAM-BB6	2.000	PZ																																						
VL1166A0	RACCORDO A L BAM-BB6	2.000	PZ																																						
VL1437A0	DISTRIBUTOR E INGRESSI LAVAGGIO CAPPA CBX	1.000	PZ																																						
VM1054A0	GHIERA RIDUTTORE DI PRESSIONE H7.8	1.000	PZ																																						
VM1605A0	CLIP TWIST LOCK DIAM. 10,2-12,7 MM	2.000	PZ																																						
VM2652A0	SELLA DI CABLAGGIO	1.000	PZ																																						
KVL1458A	CB -X HOOD HYDRIC SYSTEM KI	<table border="1"> <thead> <tr> <th>Code</th> <th>Description</th> <th>Qty</th> <th>UOM</th> </tr> </thead> <tbody> <tr> <td>0H8067A0</td> <td>LAMIERA SOSTEGNO EL CAPPA CBX</td> <td>1.000</td> <td>PZ</td> </tr> <tr> <td>EL1440A0</td> <td>ELETTROVALV OLA H2O AUTOPULENT E BAF EU</td> <td>2.000</td> <td>PZ</td> </tr> <tr> <td>GN1526A0</td> <td>O-RING D.INT6.9 SP1.8</td> <td>4.000</td> <td>PZ</td> </tr> <tr> <td>RC1018A0</td> <td>FASCETTA ELASTICA D12 ZINCATA</td> <td>4.000</td> <td>PZ</td> </tr> <tr> <td>RC1243A0</td> <td>RACCORDO GOMITO CODOLO Ø10F-Ø10M</td> <td>1.000</td> <td>PZ</td> </tr> <tr> <td>RC1396A0</td> <td>TERMINALE DRITTO JG D10-1/4</td> <td>2.000</td> <td>PZ</td> </tr> <tr> <td>RC1414A1</td> <td>FASCETTA STRINGITUBO A SCATTO D11.5-12.5</td> <td>4.000</td> <td>PZ</td> </tr> </tbody> </table>	Code	Description	Qty	UOM	0H8067A0	LAMIERA SOSTEGNO EL CAPPA CBX	1.000	PZ	EL1440A0	ELETTROVALV OLA H2O AUTOPULENT E BAF EU	2.000	PZ	GN1526A0	O-RING D.INT6.9 SP1.8	4.000	PZ	RC1018A0	FASCETTA ELASTICA D12 ZINCATA	4.000	PZ	RC1243A0	RACCORDO GOMITO CODOLO Ø10F-Ø10M	1.000	PZ	RC1396A0	TERMINALE DRITTO JG D10-1/4	2.000	PZ	RC1414A1	FASCETTA STRINGITUBO A SCATTO D11.5-12.5	4.000	PZ							
Code	Description	Qty	UOM																																						
0H8067A0	LAMIERA SOSTEGNO EL CAPPA CBX	1.000	PZ																																						
EL1440A0	ELETTROVALV OLA H2O AUTOPULENT E BAF EU	2.000	PZ																																						
GN1526A0	O-RING D.INT6.9 SP1.8	4.000	PZ																																						
RC1018A0	FASCETTA ELASTICA D12 ZINCATA	4.000	PZ																																						
RC1243A0	RACCORDO GOMITO CODOLO Ø10F-Ø10M	1.000	PZ																																						
RC1396A0	TERMINALE DRITTO JG D10-1/4	2.000	PZ																																						
RC1414A1	FASCETTA STRINGITUBO A SCATTO D11.5-12.5	4.000	PZ																																						

COMPONENT			SPARE PART																																										
Code	Description	Image	Code	Description	Kit components																																								
VM1054A	GHIERA RIDUTTORE DI PRESSIONE H7.8		KVL1458A	CB -X HOOD HYDRIC SYSTEM KI	<table border="1"> <thead> <tr> <th>Code</th> <th>Description</th> <th>Qty</th> <th>UOM</th> </tr> </thead> <tbody> <tr> <td>TB1663A0</td> <td>TB3132-TUBO EPDM CONDENSATO RE SP 150MM</td> <td>2.000</td> <td>PZ</td> </tr> <tr> <td>TB2867A0</td> <td>TB3132A-TUB O L75 MM</td> <td>2.000</td> <td>PZ</td> </tr> <tr> <td>VL1014B3</td> <td>RIDUTTORE DI PRESSIONE CON DISTRIBUTOR</td> <td>1.000</td> <td>PZ</td> </tr> <tr> <td>VL1165A0</td> <td>RACCORDO DRITTO BAM-BB6</td> <td>2.000</td> <td>PZ</td> </tr> <tr> <td>VL1166A0</td> <td>RACCORDO A L BAM-BB6</td> <td>2.000</td> <td>PZ</td> </tr> <tr> <td>VL1437A0</td> <td>DISTRIBUTOR E INGRESSI LAVAGGIO CAPPA CBX</td> <td>1.000</td> <td>PZ</td> </tr> <tr> <td>VM1054A0</td> <td>GHIERA RIDUTTORE DI PRESSIONE H7.8</td> <td>1.000</td> <td>PZ</td> </tr> <tr> <td>VM1605A0</td> <td>CLIP TWIST LOCK DIAM. 10,2-12,7 MM</td> <td>2.000</td> <td>PZ</td> </tr> <tr> <td>VM2652A0</td> <td>SELLA DI CABLAGGIO</td> <td>1.000</td> <td>PZ</td> </tr> </tbody> </table>	Code	Description	Qty	UOM	TB1663A0	TB3132-TUBO EPDM CONDENSATO RE SP 150MM	2.000	PZ	TB2867A0	TB3132A-TUB O L75 MM	2.000	PZ	VL1014B3	RIDUTTORE DI PRESSIONE CON DISTRIBUTOR	1.000	PZ	VL1165A0	RACCORDO DRITTO BAM-BB6	2.000	PZ	VL1166A0	RACCORDO A L BAM-BB6	2.000	PZ	VL1437A0	DISTRIBUTOR E INGRESSI LAVAGGIO CAPPA CBX	1.000	PZ	VM1054A0	GHIERA RIDUTTORE DI PRESSIONE H7.8	1.000	PZ	VM1605A0	CLIP TWIST LOCK DIAM. 10,2-12,7 MM	2.000	PZ	VM2652A0	SELLA DI CABLAGGIO	1.000	PZ
			Code	Description	Qty	UOM																																							
TB1663A0	TB3132-TUBO EPDM CONDENSATO RE SP 150MM	2.000	PZ																																										
TB2867A0	TB3132A-TUB O L75 MM	2.000	PZ																																										
VL1014B3	RIDUTTORE DI PRESSIONE CON DISTRIBUTOR	1.000	PZ																																										
VL1165A0	RACCORDO DRITTO BAM-BB6	2.000	PZ																																										
VL1166A0	RACCORDO A L BAM-BB6	2.000	PZ																																										
VL1437A0	DISTRIBUTOR E INGRESSI LAVAGGIO CAPPA CBX	1.000	PZ																																										
VM1054A0	GHIERA RIDUTTORE DI PRESSIONE H7.8	1.000	PZ																																										
VM1605A0	CLIP TWIST LOCK DIAM. 10,2-12,7 MM	2.000	PZ																																										
VM2652A0	SELLA DI CABLAGGIO	1.000	PZ																																										
KVL1413A	EU SPEED-X HOOD WASHING KIT	<table border="1"> <thead> <tr> <th>Code</th> <th>Description</th> <th>Qty</th> <th>UOM</th> </tr> </thead> <tbody> <tr> <td>0H2514A1</td> <td>LAMIERA SOSTEGNO EL1440</td> <td>1.000</td> <td>PZ</td> </tr> <tr> <td>0H5472A0</td> <td>PORTA COMPONENTI CAPPA SPEED.X</td> <td>1.000</td> <td>PZ</td> </tr> <tr> <td>EL1440A0</td> <td>ELETTROVALV OLA H2O AUTOPULENT E BAF EU</td> <td>1.000</td> <td>PZ</td> </tr> <tr> <td>GN1526A0</td> <td>O-RING D.INT6.9 SP1.8</td> <td>2.000</td> <td>PZ</td> </tr> <tr> <td>RC1018A0</td> <td>FASCETTA ELASTICA D12 ZINCATO</td> <td>4.000</td> <td>PZ</td> </tr> <tr> <td>RC1243A0</td> <td>RACCORDO GOMITO CODOLO Ø10F-Ø10M</td> <td>1.000</td> <td>PZ</td> </tr> <tr> <td>RC1396A0</td> <td>TERMINALE DRITTO JG D10-1/4</td> <td>2.000</td> <td>PZ</td> </tr> </tbody> </table>	Code	Description	Qty	UOM	0H2514A1	LAMIERA SOSTEGNO EL1440	1.000	PZ	0H5472A0	PORTA COMPONENTI CAPPA SPEED.X	1.000	PZ	EL1440A0	ELETTROVALV OLA H2O AUTOPULENT E BAF EU	1.000	PZ	GN1526A0	O-RING D.INT6.9 SP1.8	2.000	PZ	RC1018A0	FASCETTA ELASTICA D12 ZINCATO	4.000	PZ	RC1243A0	RACCORDO GOMITO CODOLO Ø10F-Ø10M	1.000	PZ	RC1396A0	TERMINALE DRITTO JG D10-1/4	2.000	PZ											
Code	Description	Qty	UOM																																										
0H2514A1	LAMIERA SOSTEGNO EL1440	1.000	PZ																																										
0H5472A0	PORTA COMPONENTI CAPPA SPEED.X	1.000	PZ																																										
EL1440A0	ELETTROVALV OLA H2O AUTOPULENT E BAF EU	1.000	PZ																																										
GN1526A0	O-RING D.INT6.9 SP1.8	2.000	PZ																																										
RC1018A0	FASCETTA ELASTICA D12 ZINCATO	4.000	PZ																																										
RC1243A0	RACCORDO GOMITO CODOLO Ø10F-Ø10M	1.000	PZ																																										
RC1396A0	TERMINALE DRITTO JG D10-1/4	2.000	PZ																																										

COMPONENT			SPARE PART																																										
Code	Description	Image	Code	Description	Kit components																																								
VM1054A	GHIERA RIDUTTORE DI PRESSIONE H7.8		KVL1413A	EU SPEED-X HOOD WASHING KIT	<table border="1"> <thead> <tr> <th>Code</th> <th>Description</th> <th>Qty</th> <th>UOM</th> </tr> </thead> <tbody> <tr> <td>TB3252A0</td> <td>TB3132A-L=23 0MM EPDM BIANCO BLU</td> <td>1.000</td> <td>PZ</td> </tr> <tr> <td>TB3426A0</td> <td>TB3132A-TUB O EPDM BIANCO BLU L90</td> <td>1.000</td> <td>PZ</td> </tr> <tr> <td>VI1220A1</td> <td>VITE AUTOFIL. 4.2X11 TCS+ MARUTEX</td> <td>2.000</td> <td>PZ</td> </tr> <tr> <td>VL1014B3</td> <td>RIDUTTORE DI PRESSIONE CON DISTRIBUTOR</td> <td>1.000</td> <td>PZ</td> </tr> <tr> <td>VL1095A0</td> <td>RACCORDO DRITTO M-M PORTAGOMM A D7.8-D10</td> <td>1.000</td> <td>PZ</td> </tr> <tr> <td>VL1165A0</td> <td>RACCORDO DRITTO BAM-BB6</td> <td>2.000</td> <td>PZ</td> </tr> <tr> <td>VM1054A0</td> <td>GHIERA RIDUTTORE DI PRESSIONE H7.8</td> <td>1.000</td> <td>PZ</td> </tr> <tr> <td>VM1605A0</td> <td>CLIP TWIST LOCK DIAM. 10.2-12.7 MM</td> <td>1.000</td> <td>PZ</td> </tr> <tr> <td>VM2652A0</td> <td>SELLA DI CABLAGGIO</td> <td>1.000</td> <td>PZ</td> </tr> </tbody> </table>	Code	Description	Qty	UOM	TB3252A0	TB3132A-L=23 0MM EPDM BIANCO BLU	1.000	PZ	TB3426A0	TB3132A-TUB O EPDM BIANCO BLU L90	1.000	PZ	VI1220A1	VITE AUTOFIL. 4.2X11 TCS+ MARUTEX	2.000	PZ	VL1014B3	RIDUTTORE DI PRESSIONE CON DISTRIBUTOR	1.000	PZ	VL1095A0	RACCORDO DRITTO M-M PORTAGOMM A D7.8-D10	1.000	PZ	VL1165A0	RACCORDO DRITTO BAM-BB6	2.000	PZ	VM1054A0	GHIERA RIDUTTORE DI PRESSIONE H7.8	1.000	PZ	VM1605A0	CLIP TWIST LOCK DIAM. 10.2-12.7 MM	1.000	PZ	VM2652A0	SELLA DI CABLAGGIO	1.000	PZ
			Code	Description	Qty	UOM																																							
TB3252A0	TB3132A-L=23 0MM EPDM BIANCO BLU	1.000	PZ																																										
TB3426A0	TB3132A-TUB O EPDM BIANCO BLU L90	1.000	PZ																																										
VI1220A1	VITE AUTOFIL. 4.2X11 TCS+ MARUTEX	2.000	PZ																																										
VL1014B3	RIDUTTORE DI PRESSIONE CON DISTRIBUTOR	1.000	PZ																																										
VL1095A0	RACCORDO DRITTO M-M PORTAGOMM A D7.8-D10	1.000	PZ																																										
VL1165A0	RACCORDO DRITTO BAM-BB6	2.000	PZ																																										
VM1054A0	GHIERA RIDUTTORE DI PRESSIONE H7.8	1.000	PZ																																										
VM1605A0	CLIP TWIST LOCK DIAM. 10.2-12.7 MM	1.000	PZ																																										
VM2652A0	SELLA DI CABLAGGIO	1.000	PZ																																										
KVL1163A	MIND.Maps INLET CONNECTING PIPE KIT	<table border="1"> <thead> <tr> <th>Code</th> <th>Description</th> <th>Qty</th> <th>UOM</th> </tr> </thead> <tbody> <tr> <td>0H8038A0</td> <td>LAMIERA SUPPORTO RIDUTTORE M</td> <td>1.000</td> <td>PZ</td> </tr> <tr> <td>0H8039A0</td> <td>LAMIERA SUPPORTO RIDUTTORE COMPACT MM</td> <td>1.000</td> <td>PZ</td> </tr> <tr> <td>CH1026A0</td> <td>CHIAVE J.G. UNOX D8-D10</td> <td>1.000</td> <td>PZ</td> </tr> <tr> <td>RC1243A0</td> <td>RACCORDO GOMITO CODOLO Ø10F-Ø10M</td> <td>2.000</td> <td>PZ</td> </tr> <tr> <td>RC1396A0</td> <td>TERMINALE DRITTO JG D10-1/4</td> <td>2.000</td> <td>PZ</td> </tr> <tr> <td>TB2243A0</td> <td>TUBO D10 PE TRASPARENT</td> <td>0.050</td> <td>M</td> </tr> <tr> <td>VI1220A1</td> <td>VITE AUTOFIL. 4.2X11 TCS+ MARUTEX</td> <td>2.000</td> <td>PZ</td> </tr> </tbody> </table>	Code	Description	Qty	UOM	0H8038A0	LAMIERA SUPPORTO RIDUTTORE M	1.000	PZ	0H8039A0	LAMIERA SUPPORTO RIDUTTORE COMPACT MM	1.000	PZ	CH1026A0	CHIAVE J.G. UNOX D8-D10	1.000	PZ	RC1243A0	RACCORDO GOMITO CODOLO Ø10F-Ø10M	2.000	PZ	RC1396A0	TERMINALE DRITTO JG D10-1/4	2.000	PZ	TB2243A0	TUBO D10 PE TRASPARENT	0.050	M	VI1220A1	VITE AUTOFIL. 4.2X11 TCS+ MARUTEX	2.000	PZ											
Code	Description	Qty	UOM																																										
0H8038A0	LAMIERA SUPPORTO RIDUTTORE M	1.000	PZ																																										
0H8039A0	LAMIERA SUPPORTO RIDUTTORE COMPACT MM	1.000	PZ																																										
CH1026A0	CHIAVE J.G. UNOX D8-D10	1.000	PZ																																										
RC1243A0	RACCORDO GOMITO CODOLO Ø10F-Ø10M	2.000	PZ																																										
RC1396A0	TERMINALE DRITTO JG D10-1/4	2.000	PZ																																										
TB2243A0	TUBO D10 PE TRASPARENT	0.050	M																																										
VI1220A1	VITE AUTOFIL. 4.2X11 TCS+ MARUTEX	2.000	PZ																																										

COMPONENT			SPARE PART																						
Code	Description	Image	Code	Description	Kit components																				
VM1054A	GHIERA RIDUTTORE DI PRESSIONE H7.8		KVL1163A	MIND.Maps INLET CONNECTING PIPE KIT	<table border="1"> <thead> <tr> <th>Code</th> <th>Description</th> <th>Qty</th> <th>UOM</th> </tr> </thead> <tbody> <tr> <td>VI1950A0</td> <td>VITE AUTOFORANT E 4,2X13 TCB INOX</td> <td>1.000</td> <td>PZ</td> </tr> <tr> <td>VL1014B3</td> <td>RIDUTTORE DI PRESSIONE CON DISTRIBUTOR</td> <td>1.000</td> <td>PZ</td> </tr> <tr> <td>VL1135A1</td> <td>RACCORDO 3/4-JG10 CON FILTRO E VNR</td> <td>1.000</td> <td>PZ</td> </tr> <tr> <td>VM1054A0</td> <td>GHIERA RIDUTTORE DI PRESSIONE H7.8</td> <td>1.000</td> <td>PZ</td> </tr> </tbody> </table>	Code	Description	Qty	UOM	VI1950A0	VITE AUTOFORANT E 4,2X13 TCB INOX	1.000	PZ	VL1014B3	RIDUTTORE DI PRESSIONE CON DISTRIBUTOR	1.000	PZ	VL1135A1	RACCORDO 3/4-JG10 CON FILTRO E VNR	1.000	PZ	VM1054A0	GHIERA RIDUTTORE DI PRESSIONE H7.8	1.000	PZ
			Code	Description	Qty	UOM																			
			VI1950A0	VITE AUTOFORANT E 4,2X13 TCB INOX	1.000	PZ																			
			VL1014B3	RIDUTTORE DI PRESSIONE CON DISTRIBUTOR	1.000	PZ																			
			VL1135A1	RACCORDO 3/4-JG10 CON FILTRO E VNR	1.000	PZ																			
			VM1054A0	GHIERA RIDUTTORE DI PRESSIONE H7.8	1.000	PZ																			
			KVL0020A	PRESS.REDUCER 03-05XX≥OCT18/MM -LUX≥MAR19	<table border="1"> <thead> <tr> <th>Code</th> <th>Description</th> <th>Qty</th> <th>UOM</th> </tr> </thead> <tbody> <tr> <td>RC1396A0</td> <td>TERMINALE DRITTO JG D10-1/4</td> <td>2.000</td> <td>PZ</td> </tr> <tr> <td>VL1014B3</td> <td>RIDUTTORE DI PRESSIONE CON DISTRIBUTOR</td> <td>1.000</td> <td>PZ</td> </tr> <tr> <td>VM1054A0</td> <td>GHIERA RIDUTTORE DI PRESSIONE H7.8</td> <td>1.000</td> <td>PZ</td> </tr> </tbody> </table>	Code	Description	Qty	UOM	RC1396A0	TERMINALE DRITTO JG D10-1/4	2.000	PZ	VL1014B3	RIDUTTORE DI PRESSIONE CON DISTRIBUTOR	1.000	PZ	VM1054A0	GHIERA RIDUTTORE DI PRESSIONE H7.8	1.000	PZ				
			Code	Description	Qty	UOM																			
			RC1396A0	TERMINALE DRITTO JG D10-1/4	2.000	PZ																			
			VL1014B3	RIDUTTORE DI PRESSIONE CON DISTRIBUTOR	1.000	PZ																			
			VM1054A0	GHIERA RIDUTTORE DI PRESSIONE H7.8	1.000	PZ																			
			KVL0014B	MIND.MAPS 2017-2018 PRESSURE REDUCER KIT	<table border="1"> <thead> <tr> <th>Code</th> <th>Description</th> <th>Qty</th> <th>UOM</th> </tr> </thead> <tbody> <tr> <td>RC1372A0</td> <td>RACCORDO DRITTO Ø10M-1/4 M CI</td> <td>1.000</td> <td>PZ</td> </tr> <tr> <td>RC1396A0</td> <td>TERMINALE DRITTO JG D10-1/4</td> <td>1.000</td> <td>PZ</td> </tr> <tr> <td>VL1014B3</td> <td>RIDUTTORE DI PRESSIONE CON DISTRIBUTOR</td> <td>1.000</td> <td>PZ</td> </tr> <tr> <td>VM1054A0</td> <td>GHIERA RIDUTTORE DI PRESSIONE H7.8</td> <td>1.000</td> <td>PZ</td> </tr> </tbody> </table>	Code	Description	Qty	UOM	RC1372A0	RACCORDO DRITTO Ø10M-1/4 M CI	1.000	PZ	RC1396A0	TERMINALE DRITTO JG D10-1/4	1.000	PZ	VL1014B3	RIDUTTORE DI PRESSIONE CON DISTRIBUTOR	1.000	PZ	VM1054A0	GHIERA RIDUTTORE DI PRESSIONE H7.8	1.000	PZ
Code	Description	Qty	UOM																						
RC1372A0	RACCORDO DRITTO Ø10M-1/4 M CI	1.000	PZ																						
RC1396A0	TERMINALE DRITTO JG D10-1/4	1.000	PZ																						
VL1014B3	RIDUTTORE DI PRESSIONE CON DISTRIBUTOR	1.000	PZ																						
VM1054A0	GHIERA RIDUTTORE DI PRESSIONE H7.8	1.000	PZ																						
KVL0014A	MM ≤2016 / LUX<2019 PRESSURE REDUCER KIT	<table border="1"> <thead> <tr> <th>Code</th> <th>Description</th> <th>Qty</th> <th>UOM</th> </tr> </thead> <tbody> <tr> <td>RC1372A0</td> <td>RACCORDO DRITTO Ø10M-1/4 M CI</td> <td>2.000</td> <td>PZ</td> </tr> <tr> <td>VL1014B3</td> <td>RIDUTTORE DI PRESSIONE CON DISTRIBUTOR</td> <td>1.000</td> <td>PZ</td> </tr> <tr> <td>VM1054A0</td> <td>GHIERA RIDUTTORE DI PRESSIONE H7.8</td> <td>1.000</td> <td>PZ</td> </tr> </tbody> </table>	Code	Description	Qty	UOM	RC1372A0	RACCORDO DRITTO Ø10M-1/4 M CI	2.000	PZ	VL1014B3	RIDUTTORE DI PRESSIONE CON DISTRIBUTOR	1.000	PZ	VM1054A0	GHIERA RIDUTTORE DI PRESSIONE H7.8	1.000	PZ							
Code	Description	Qty	UOM																						
RC1372A0	RACCORDO DRITTO Ø10M-1/4 M CI	2.000	PZ																						
VL1014B3	RIDUTTORE DI PRESSIONE CON DISTRIBUTOR	1.000	PZ																						
VM1054A0	GHIERA RIDUTTORE DI PRESSIONE H7.8	1.000	PZ																						

COMPONENT			SPARE PART			
Code	Description	Image	Code	Description	Kit components	
VM1054A	GHIERA RIDUTTORE DI PRESSIONE H7.8		KVA0003B	MIND.MAPS -M SUGGESTED PARTS KIT	Code	Description Qty UOM
					0H2842A0	MASCHERA CENTRAGGIO MT1012 1.000 PZ
					0H8118A0	DISCO TENUTA ALBERO MOTORE XEVL 1.000 PZ
					0H8119A0	COPERCHIO INGRESSO SONDA CUORE XEVL 316 1.000 PZ
					0H8120A0	COPERCHIO INGRESSO BULBO XEVL 1.000 PZ
					CE1052A1	CAVO CONNESSION E CONTROLLO- USB MM 750m 1.000 PZ
					CE1061A0	CAVO ADATTATORE MINIFIT PLUG 2P-FC L100 1.000 PZ
					CE1685A0	MORSETTO FEMMINA ESTR. MRT8 P3,81 5P 1.000 PZ
					CE2007A0	CAVO MICROFIT 4PM-MINIFIT 4PF 100mm 1.000 PZ
					CN1003A0	CONDENSATO RE CORAZZATO 6,3 uF 2.000 PZ
					GN1140A3	GUARNIZIONE PORTAMOTO RE STAMPAT 1.000 PZ
					GN1531A0	GUARNIZIONE TENUTA INGRESSO BULBO 1.000 PZ
					GN1632A0	GUARNIZIONE TENUTA INGRESSO SONDA-CUOR 1.000 PZ
					GN1672A1	GUARNIZIONE RS FRENATA 1.000 PZ
					JEM0576A0	ASSEMBLAGG IO RID. PRESSIONE PER KVL0020A 1.000 PZ

COMPONENT			SPARE PART																																																																						
Code	Description	Image	Code	Description	Kit components																																																																				
VM1054A	GHIERA RIDUTTORE DI PRESSIONE H7.8		KVA0003B	MIND.MAPS -M SUGGESTED PARTS KIT	<table border="1"> <thead> <tr> <th>Code</th> <th>Description</th> <th>Qty</th> <th>UOM</th> </tr> </thead> <tbody> <tr> <td>MG1099A1</td> <td>ASSIEME MANIGLIA COMPLETO MMc</td> <td>1.000</td> <td>PZ</td> </tr> <tr> <td>MT1012A0</td> <td>MOTORE SIMMETRICO 330W 230V ALBERO D12</td> <td>1.000</td> <td>PZ</td> </tr> <tr> <td>PE1057B0</td> <td>CRUSCOTTO COMPLETO CAP MM PLUS</td> <td>1.000</td> <td>PZ</td> </tr> <tr> <td>PE1058A2</td> <td>CRUSCOTTO COMPLETO MM ONE</td> <td>1.000</td> <td>PZ</td> </tr> <tr> <td>PE1059A0</td> <td>ASM SUPPORTO USB-RESET M</td> <td>1.000</td> <td>PZ</td> </tr> <tr> <td>PE1710B1</td> <td>SENSORE MODULARE NUM GIRI E DIREZIONE</td> <td>1.000</td> <td>PZ</td> </tr> <tr> <td>PE2037A0</td> <td>SCHEDA POTENZA MM ONE</td> <td>1.000</td> <td>PZ</td> </tr> <tr> <td>PE2038A0</td> <td>SCHEDA POTENZA MM PLUS</td> <td>1.000</td> <td>PZ</td> </tr> <tr> <td>RC1019A0</td> <td>FASCETTA ELASTICA D10 ZINCATA</td> <td>5.000</td> <td>PZ</td> </tr> <tr> <td>RC1414A1</td> <td>FASCETTA STRINGITUBO A SCATTO D11.5-12.5</td> <td>4.000</td> <td>PZ</td> </tr> <tr> <td>RS1034A0</td> <td>RES PIANA 147W 105V 1 SPIRA CON CONCA</td> <td>1.000</td> <td>PZ</td> </tr> <tr> <td>RS1036A0</td> <td>RES PIANA 100W 60V 1 SPIRA CON CONCA</td> <td>1.000</td> <td>PZ</td> </tr> <tr> <td>SL1045A0</td> <td>SILICONE ANTRACITE S57 80 ml</td> <td>1.000</td> <td>PZ</td> </tr> <tr> <td>SN1002B2</td> <td>SONDA CUORE MULTIP DRITTA L2050 NO RACC</td> <td>1.000</td> <td>PZ</td> </tr> <tr> <td>TB2821A0</td> <td>TB2820A-L=40 MM EPDM NER</td> <td>1.000</td> <td>PZ</td> </tr> <tr> <td>TB3225B0</td> <td>TB2820A-TUB O EPDM NERO 670MM</td> <td>1.000</td> <td>PZ</td> </tr> </tbody> </table>	Code	Description	Qty	UOM	MG1099A1	ASSIEME MANIGLIA COMPLETO MMc	1.000	PZ	MT1012A0	MOTORE SIMMETRICO 330W 230V ALBERO D12	1.000	PZ	PE1057B0	CRUSCOTTO COMPLETO CAP MM PLUS	1.000	PZ	PE1058A2	CRUSCOTTO COMPLETO MM ONE	1.000	PZ	PE1059A0	ASM SUPPORTO USB-RESET M	1.000	PZ	PE1710B1	SENSORE MODULARE NUM GIRI E DIREZIONE	1.000	PZ	PE2037A0	SCHEDA POTENZA MM ONE	1.000	PZ	PE2038A0	SCHEDA POTENZA MM PLUS	1.000	PZ	RC1019A0	FASCETTA ELASTICA D10 ZINCATA	5.000	PZ	RC1414A1	FASCETTA STRINGITUBO A SCATTO D11.5-12.5	4.000	PZ	RS1034A0	RES PIANA 147W 105V 1 SPIRA CON CONCA	1.000	PZ	RS1036A0	RES PIANA 100W 60V 1 SPIRA CON CONCA	1.000	PZ	SL1045A0	SILICONE ANTRACITE S57 80 ml	1.000	PZ	SN1002B2	SONDA CUORE MULTIP DRITTA L2050 NO RACC	1.000	PZ	TB2821A0	TB2820A-L=40 MM EPDM NER	1.000	PZ	TB3225B0	TB2820A-TUB O EPDM NERO 670MM	1.000	PZ
Code	Description	Qty	UOM																																																																						
MG1099A1	ASSIEME MANIGLIA COMPLETO MMc	1.000	PZ																																																																						
MT1012A0	MOTORE SIMMETRICO 330W 230V ALBERO D12	1.000	PZ																																																																						
PE1057B0	CRUSCOTTO COMPLETO CAP MM PLUS	1.000	PZ																																																																						
PE1058A2	CRUSCOTTO COMPLETO MM ONE	1.000	PZ																																																																						
PE1059A0	ASM SUPPORTO USB-RESET M	1.000	PZ																																																																						
PE1710B1	SENSORE MODULARE NUM GIRI E DIREZIONE	1.000	PZ																																																																						
PE2037A0	SCHEDA POTENZA MM ONE	1.000	PZ																																																																						
PE2038A0	SCHEDA POTENZA MM PLUS	1.000	PZ																																																																						
RC1019A0	FASCETTA ELASTICA D10 ZINCATA	5.000	PZ																																																																						
RC1414A1	FASCETTA STRINGITUBO A SCATTO D11.5-12.5	4.000	PZ																																																																						
RS1034A0	RES PIANA 147W 105V 1 SPIRA CON CONCA	1.000	PZ																																																																						
RS1036A0	RES PIANA 100W 60V 1 SPIRA CON CONCA	1.000	PZ																																																																						
SL1045A0	SILICONE ANTRACITE S57 80 ml	1.000	PZ																																																																						
SN1002B2	SONDA CUORE MULTIP DRITTA L2050 NO RACC	1.000	PZ																																																																						
TB2821A0	TB2820A-L=40 MM EPDM NER	1.000	PZ																																																																						
TB3225B0	TB2820A-TUB O EPDM NERO 670MM	1.000	PZ																																																																						

COMPONENT			SPARE PART																																																																							
Code	Description	Image	Code	Description	Kit components																																																																					
VM1054A	GHIERA RIDUTTORE DI PRESSIONE H7.8		KVA0003B	MIND.MAPS -M SUGGESTED PARTS KIT	<table border="1"> <thead> <tr> <th>Code</th> <th>Description</th> <th>Qty</th> <th>UOM</th> </tr> </thead> <tbody> <tr> <td>TR1136A0</td> <td>TERMOSTATO SIC. UNIP. 318°C -0/+24</td> <td>1.000</td> <td>PZ</td> </tr> <tr> <td>VE1020B0</td> <td>MICROINT. PORTA MAGNETICO CON MINIFIT 2</td> <td>1.000</td> <td>PZ</td> </tr> <tr> <td>VE1026A0</td> <td>TRASFORMAT ORE 230-21-12Vac 90VA</td> <td>1.000</td> <td>PZ</td> </tr> <tr> <td>VE1030A1</td> <td>CALAMITA D=22,9mm PER MICROPORTA</td> <td>1.000</td> <td>PZ</td> </tr> <tr> <td>VE1639A0</td> <td>TRASFORMAT ORE 230-12Vac 60V</td> <td>1.000</td> <td>PZ</td> </tr> <tr> <td>VI1074A0</td> <td>VITE PER PLASTICA 4X16 TPBS+ INOX</td> <td>2.000</td> <td>PZ</td> </tr> <tr> <td>VI1077A1</td> <td>VITE M6x12 TE INOX</td> <td>1.000</td> <td>PZ</td> </tr> <tr> <td>VI1122A0</td> <td>VITE M6X12 TE INOX A4 316</td> <td>1.000</td> <td>PZ</td> </tr> <tr> <td>VI1123A0</td> <td>RONDELLA PIANA M6 INOX A4 AISI316</td> <td>1.000</td> <td>PZ</td> </tr> <tr> <td>VI1192A0</td> <td>DADO M10X0,75 H3 OTTONE NICHELATO</td> <td>1.000</td> <td>PZ</td> </tr> <tr> <td>VI1220A1</td> <td>VITE AUTOFIL. 4,2X11 TCS+ MARUTEX</td> <td>3.000</td> <td>PZ</td> </tr> <tr> <td>VI1521A0</td> <td>RONDELLA PIANA 6x12x1 INOX</td> <td>1.000</td> <td>PZ</td> </tr> <tr> <td>VI1850A0</td> <td>VITE M4X6 TCB+ NICHELATA</td> <td>12.000</td> <td>PZ</td> </tr> <tr> <td>VI1931A0</td> <td>DADO CONDENSATO RE M8x1,65 H4 CH13 ZINC</td> <td>2.000</td> <td>PZ</td> </tr> <tr> <td>VI1932A0</td> <td>RONDELLA DENTELLATA CONDENSATO RE D8 ZINC</td> <td>2.000</td> <td>PZ</td> </tr> <tr> <td>VI1950A0</td> <td>VITE AUTOFORANT E 4,2X13 TCB INOX</td> <td>4.000</td> <td>PZ</td> </tr> </tbody> </table>	Code	Description	Qty	UOM	TR1136A0	TERMOSTATO SIC. UNIP. 318°C -0/+24	1.000	PZ	VE1020B0	MICROINT. PORTA MAGNETICO CON MINIFIT 2	1.000	PZ	VE1026A0	TRASFORMAT ORE 230-21-12Vac 90VA	1.000	PZ	VE1030A1	CALAMITA D=22,9mm PER MICROPORTA	1.000	PZ	VE1639A0	TRASFORMAT ORE 230-12Vac 60V	1.000	PZ	VI1074A0	VITE PER PLASTICA 4X16 TPBS+ INOX	2.000	PZ	VI1077A1	VITE M6x12 TE INOX	1.000	PZ	VI1122A0	VITE M6X12 TE INOX A4 316	1.000	PZ	VI1123A0	RONDELLA PIANA M6 INOX A4 AISI316	1.000	PZ	VI1192A0	DADO M10X0,75 H3 OTTONE NICHELATO	1.000	PZ	VI1220A1	VITE AUTOFIL. 4,2X11 TCS+ MARUTEX	3.000	PZ	VI1521A0	RONDELLA PIANA 6x12x1 INOX	1.000	PZ	VI1850A0	VITE M4X6 TCB+ NICHELATA	12.000	PZ	VI1931A0	DADO CONDENSATO RE M8x1,65 H4 CH13 ZINC	2.000	PZ	VI1932A0	RONDELLA DENTELLATA CONDENSATO RE D8 ZINC	2.000	PZ	VI1950A0	VITE AUTOFORANT E 4,2X13 TCB INOX	4.000	PZ	
Code	Description	Qty	UOM																																																																							
TR1136A0	TERMOSTATO SIC. UNIP. 318°C -0/+24	1.000	PZ																																																																							
VE1020B0	MICROINT. PORTA MAGNETICO CON MINIFIT 2	1.000	PZ																																																																							
VE1026A0	TRASFORMAT ORE 230-21-12Vac 90VA	1.000	PZ																																																																							
VE1030A1	CALAMITA D=22,9mm PER MICROPORTA	1.000	PZ																																																																							
VE1639A0	TRASFORMAT ORE 230-12Vac 60V	1.000	PZ																																																																							
VI1074A0	VITE PER PLASTICA 4X16 TPBS+ INOX	2.000	PZ																																																																							
VI1077A1	VITE M6x12 TE INOX	1.000	PZ																																																																							
VI1122A0	VITE M6X12 TE INOX A4 316	1.000	PZ																																																																							
VI1123A0	RONDELLA PIANA M6 INOX A4 AISI316	1.000	PZ																																																																							
VI1192A0	DADO M10X0,75 H3 OTTONE NICHELATO	1.000	PZ																																																																							
VI1220A1	VITE AUTOFIL. 4,2X11 TCS+ MARUTEX	3.000	PZ																																																																							
VI1521A0	RONDELLA PIANA 6x12x1 INOX	1.000	PZ																																																																							
VI1850A0	VITE M4X6 TCB+ NICHELATA	12.000	PZ																																																																							
VI1931A0	DADO CONDENSATO RE M8x1,65 H4 CH13 ZINC	2.000	PZ																																																																							
VI1932A0	RONDELLA DENTELLATA CONDENSATO RE D8 ZINC	2.000	PZ																																																																							
VI1950A0	VITE AUTOFORANT E 4,2X13 TCB INOX	4.000	PZ																																																																							

COMPONENT			SPARE PART																																																																						
Code	Description	Image	Code	Description	Kit components																																																																				
VM1054A	GHIERA RIDUTTORE DI PRESSIONE H7.8		KVA0003B	MIND.MAPS -M SUGGESTED PARTS KIT	<table border="1"> <thead> <tr> <th>Code</th> <th>Description</th> <th>Qty</th> <th>UOM</th> </tr> </thead> <tbody> <tr> <td>VI1966A1</td> <td>VITE M4X14 TSP+ ZN</td> <td>1.000</td> <td>PZ</td> </tr> <tr> <td>VL1047A1</td> <td>PORTAGOMM A D6 CODOLO D8</td> <td>1.000</td> <td>PZ</td> </tr> <tr> <td>VL1102A1</td> <td>FILTRO IN LINEA DET. + VNR BARBED 6 MM</td> <td>1.000</td> <td>PZ</td> </tr> <tr> <td>VL1182A3</td> <td>ASM LAVAGGIO ONE MONO GIRANTE</td> <td>1.000</td> <td>PZ</td> </tr> <tr> <td>VL1183A2</td> <td>ASM LAVAGGIO PLUS MONO GIRANTE</td> <td>1.000</td> <td>PZ</td> </tr> <tr> <td>VM1447A0</td> <td>BUSTA AIRBALL ESD ROSA 230X450 MM</td> <td>0.500</td> <td>PZ</td> </tr> <tr> <td>VM1490A0</td> <td>COPRI VITI MANIGLIA CHEFTOP BAKERTOP</td> <td>2.000</td> <td>PZ</td> </tr> <tr> <td>VM1605A0</td> <td>CLIP TWIST LOCK DIAM. 10,2-12,7 MM</td> <td>3.000</td> <td>PZ</td> </tr> <tr> <td>VM1745A0</td> <td>SUPPORTO PER SCHEDA</td> <td>9.000</td> <td>PZ</td> </tr> <tr> <td>VM2295A1</td> <td>PENNINO CONTROLLO MM</td> <td>1.000</td> <td>PZ</td> </tr> <tr> <td>VM2880A0</td> <td>ASM MGT MISURA NUMERO GIRI</td> <td>1.000</td> <td>PZ</td> </tr> <tr> <td>VN1184A0</td> <td>VENTOLA D195 H80 PALE SCARICATE</td> <td>1.000</td> <td>PZ</td> </tr> <tr> <td>VP1005A0</td> <td>SUPPORTO CONTROLLO PORTA BIG-L</td> <td>1.000</td> <td>PZ</td> </tr> <tr> <td>VP1005B0</td> <td>SUPPORTO CONTROLLO BIG-L PORTA 70 MM</td> <td>1.000</td> <td>PZ</td> </tr> <tr> <td>VP1067A0</td> <td>DISTANZIALE RETROFIT PER CONTROLLO MM</td> <td>1.000</td> <td>PZ</td> </tr> <tr> <td>VP1078A0</td> <td>CORNICE RETROFIT PER CONTROLLO MM</td> <td>1.000</td> <td>PZ</td> </tr> </tbody> </table>	Code	Description	Qty	UOM	VI1966A1	VITE M4X14 TSP+ ZN	1.000	PZ	VL1047A1	PORTAGOMM A D6 CODOLO D8	1.000	PZ	VL1102A1	FILTRO IN LINEA DET. + VNR BARBED 6 MM	1.000	PZ	VL1182A3	ASM LAVAGGIO ONE MONO GIRANTE	1.000	PZ	VL1183A2	ASM LAVAGGIO PLUS MONO GIRANTE	1.000	PZ	VM1447A0	BUSTA AIRBALL ESD ROSA 230X450 MM	0.500	PZ	VM1490A0	COPRI VITI MANIGLIA CHEFTOP BAKERTOP	2.000	PZ	VM1605A0	CLIP TWIST LOCK DIAM. 10,2-12,7 MM	3.000	PZ	VM1745A0	SUPPORTO PER SCHEDA	9.000	PZ	VM2295A1	PENNINO CONTROLLO MM	1.000	PZ	VM2880A0	ASM MGT MISURA NUMERO GIRI	1.000	PZ	VN1184A0	VENTOLA D195 H80 PALE SCARICATE	1.000	PZ	VP1005A0	SUPPORTO CONTROLLO PORTA BIG-L	1.000	PZ	VP1005B0	SUPPORTO CONTROLLO BIG-L PORTA 70 MM	1.000	PZ	VP1067A0	DISTANZIALE RETROFIT PER CONTROLLO MM	1.000	PZ	VP1078A0	CORNICE RETROFIT PER CONTROLLO MM	1.000	PZ
Code	Description	Qty	UOM																																																																						
VI1966A1	VITE M4X14 TSP+ ZN	1.000	PZ																																																																						
VL1047A1	PORTAGOMM A D6 CODOLO D8	1.000	PZ																																																																						
VL1102A1	FILTRO IN LINEA DET. + VNR BARBED 6 MM	1.000	PZ																																																																						
VL1182A3	ASM LAVAGGIO ONE MONO GIRANTE	1.000	PZ																																																																						
VL1183A2	ASM LAVAGGIO PLUS MONO GIRANTE	1.000	PZ																																																																						
VM1447A0	BUSTA AIRBALL ESD ROSA 230X450 MM	0.500	PZ																																																																						
VM1490A0	COPRI VITI MANIGLIA CHEFTOP BAKERTOP	2.000	PZ																																																																						
VM1605A0	CLIP TWIST LOCK DIAM. 10,2-12,7 MM	3.000	PZ																																																																						
VM1745A0	SUPPORTO PER SCHEDA	9.000	PZ																																																																						
VM2295A1	PENNINO CONTROLLO MM	1.000	PZ																																																																						
VM2880A0	ASM MGT MISURA NUMERO GIRI	1.000	PZ																																																																						
VN1184A0	VENTOLA D195 H80 PALE SCARICATE	1.000	PZ																																																																						
VP1005A0	SUPPORTO CONTROLLO PORTA BIG-L	1.000	PZ																																																																						
VP1005B0	SUPPORTO CONTROLLO BIG-L PORTA 70 MM	1.000	PZ																																																																						
VP1067A0	DISTANZIALE RETROFIT PER CONTROLLO MM	1.000	PZ																																																																						
VP1078A0	CORNICE RETROFIT PER CONTROLLO MM	1.000	PZ																																																																						



COMPONENT			SPARE PART																														
Code	Description	Image	Code	Description	Kit components																												
VL1483A	ASM RACCORDO A T CON MGT		KVL1483A	CHEFTOP-X T-CONNECTION WITH MAGNETS KIT	<table border="1"> <thead> <tr> <th>Code</th> <th>Description</th> <th>Qty</th> <th>UOM</th> </tr> </thead> <tbody> <tr> <td>GN1526A0</td> <td>O-RING D.INT6.9 SP1.8</td> <td>1.000</td> <td>PZ</td> </tr> <tr> <td>RC1414A1</td> <td>FASCETTA STRINGITUBO A SCATTO D11.5-12.5</td> <td>2.000</td> <td>PZ</td> </tr> <tr> <td>TB4131A0</td> <td>TB3132A-TUB O BIANCO BLU EPDM L210MM</td> <td>1.000</td> <td>PZ</td> </tr> <tr> <td>VL1166A0</td> <td>RACCORDO A L BAM-BB6</td> <td>1.000</td> <td>PZ</td> </tr> <tr> <td>VL1277A0</td> <td>CLIP RACCORDO BAIONETTA POLIMERO</td> <td>1.000</td> <td>PZ</td> </tr> <tr> <td>VL1483A1</td> <td>ASM RACCORDO A T CON MGT</td> <td>1.000</td> <td>PZ</td> </tr> </tbody> </table>	Code	Description	Qty	UOM	GN1526A0	O-RING D.INT6.9 SP1.8	1.000	PZ	RC1414A1	FASCETTA STRINGITUBO A SCATTO D11.5-12.5	2.000	PZ	TB4131A0	TB3132A-TUB O BIANCO BLU EPDM L210MM	1.000	PZ	VL1166A0	RACCORDO A L BAM-BB6	1.000	PZ	VL1277A0	CLIP RACCORDO BAIONETTA POLIMERO	1.000	PZ	VL1483A1	ASM RACCORDO A T CON MGT	1.000	PZ
			Code	Description	Qty	UOM																											
GN1526A0	O-RING D.INT6.9 SP1.8	1.000	PZ																														
RC1414A1	FASCETTA STRINGITUBO A SCATTO D11.5-12.5	2.000	PZ																														
TB4131A0	TB3132A-TUB O BIANCO BLU EPDM L210MM	1.000	PZ																														
VL1166A0	RACCORDO A L BAM-BB6	1.000	PZ																														
VL1277A0	CLIP RACCORDO BAIONETTA POLIMERO	1.000	PZ																														
VL1483A1	ASM RACCORDO A T CON MGT	1.000	PZ																														
KVL1096A	MIND.Maps T-SHAPED FITTING+2 MAGNETS KIT	<table border="1"> <thead> <tr> <th>Code</th> <th>Description</th> <th>Qty</th> <th>UOM</th> </tr> </thead> <tbody> <tr> <td>RC1414A1</td> <td>FASCETTA STRINGITUBO A SCATTO D11.5-12.5</td> <td>5.000</td> <td>PZ</td> </tr> <tr> <td>VL1483A1</td> <td>ASM RACCORDO A T CON MGT</td> <td>1.000</td> <td>PZ</td> </tr> </tbody> </table>	Code	Description	Qty	UOM	RC1414A1	FASCETTA STRINGITUBO A SCATTO D11.5-12.5	5.000	PZ	VL1483A1	ASM RACCORDO A T CON MGT	1.000	PZ																			
Code	Description	Qty	UOM																														
RC1414A1	FASCETTA STRINGITUBO A SCATTO D11.5-12.5	5.000	PZ																														
VL1483A1	ASM RACCORDO A T CON MGT	1.000	PZ																														
VL1026A	CURVA PER TUBO DI SCARICO		KVL1026A	DRAIN PIPE BEND KI	<table border="1"> <thead> <tr> <th>Code</th> <th>Description</th> <th>Qty</th> <th>UOM</th> </tr> </thead> <tbody> <tr> <td>GN1400A0</td> <td>GUARNIZIONE SIFONE</td> <td>1.000</td> <td>PZ</td> </tr> <tr> <td>VL1026A0</td> <td>CURVA PER TUBO DI SCARICO</td> <td>1.000</td> <td>PZ</td> </tr> <tr> <td>VM2039A0</td> <td>ANELLO FISSAGGIO CURVA DI SCARICO</td> <td>1.000</td> <td>PZ</td> </tr> </tbody> </table>	Code	Description	Qty	UOM	GN1400A0	GUARNIZIONE SIFONE	1.000	PZ	VL1026A0	CURVA PER TUBO DI SCARICO	1.000	PZ	VM2039A0	ANELLO FISSAGGIO CURVA DI SCARICO	1.000	PZ												
					Code	Description	Qty	UOM																									
					GN1400A0	GUARNIZIONE SIFONE	1.000	PZ																									
VL1026A0	CURVA PER TUBO DI SCARICO	1.000	PZ																														
VM2039A0	ANELLO FISSAGGIO CURVA DI SCARICO	1.000	PZ																														
VM2039A	ANELLO FISSAGGIO CURVA DI SCARICO		KVL1315A	CBX RECIRCULATION BOX KIT (NO PUMPS)	<table border="1"> <thead> <tr> <th>Code</th> <th>Description</th> <th>Qty</th> <th>UOM</th> </tr> </thead> <tbody> <tr> <td>0H6686A0</td> <td>SOSTEGNO STAFFA IDRICA DID</td> <td>1.000</td> <td>PZ</td> </tr> <tr> <td>GN1400A0</td> <td>GUARNIZIONE SIFONE</td> <td>1.000</td> <td>PZ</td> </tr> <tr> <td>RC1019A0</td> <td>FASCETTA ELASTICA D10 ZINCATA</td> <td>2.000</td> <td>PZ</td> </tr> <tr> <td>RC1360A0</td> <td>RACCORDO GOMITO JG 10-10</td> <td>2.000</td> <td>PZ</td> </tr> <tr> <td>RC1378A0</td> <td>FASCETTA STRINGI TUBO D25-40 ZINCAT</td> <td>1.000</td> <td>PZ</td> </tr> </tbody> </table>	Code	Description	Qty	UOM	0H6686A0	SOSTEGNO STAFFA IDRICA DID	1.000	PZ	GN1400A0	GUARNIZIONE SIFONE	1.000	PZ	RC1019A0	FASCETTA ELASTICA D10 ZINCATA	2.000	PZ	RC1360A0	RACCORDO GOMITO JG 10-10	2.000	PZ	RC1378A0	FASCETTA STRINGI TUBO D25-40 ZINCAT	1.000	PZ				
Code	Description				Qty	UOM																											
0H6686A0	SOSTEGNO STAFFA IDRICA DID				1.000	PZ																											
GN1400A0	GUARNIZIONE SIFONE				1.000	PZ																											
RC1019A0	FASCETTA ELASTICA D10 ZINCATA				2.000	PZ																											
RC1360A0	RACCORDO GOMITO JG 10-10	2.000	PZ																														
RC1378A0	FASCETTA STRINGI TUBO D25-40 ZINCAT	1.000	PZ																														

COMPONENT			SPARE PART																																																																														
Code	Description	Image	Code	Description	Kit components																																																																												
VM2039A	ANELLO FISSAGGIO CURVA DI SCARICO		KVL1315A	CBX RECIRCULATION BOX KIT (NO PUMPS)	<table border="1"> <thead> <tr> <th>Code</th> <th>Description</th> <th>Qty</th> <th>UOM</th> </tr> </thead> <tbody> <tr> <td>RC1410A0</td> <td>FASCETTA STRINGITUBO D16-27 INOX</td> <td>2.000</td> <td>PZ</td> </tr> <tr> <td>SN1053A0</td> <td>SENSORE DI LIVELLO</td> <td>1.000</td> <td>PZ</td> </tr> <tr> <td>SN1061A0</td> <td>SONDA NTC D4x175MM</td> <td>1.000</td> <td>PZ</td> </tr> <tr> <td>TB3822A0</td> <td>TB3454A-TUB O L 40 MM</td> <td>1.000</td> <td>PZ</td> </tr> <tr> <td>TB4135A0</td> <td>TB2820A-TUB O EPDM NERO L140MM</td> <td>1.000</td> <td>PZ</td> </tr> <tr> <td>TB4160A0</td> <td>TB2243A-TUB O PE TRASP D10 L150MM</td> <td>1.000</td> <td>PZ</td> </tr> <tr> <td>VI1103A0</td> <td>VITE PER PLASTICA 4X12 TPBS+ ZN-NI</td> <td>6.000</td> <td>PZ</td> </tr> <tr> <td>VI1189A0</td> <td>RONDELLA M5 INOX A4 D10 SP1</td> <td>2.000</td> <td>PZ</td> </tr> <tr> <td>VI1220A1</td> <td>VITE AUTOFIL. 4.2X11 TCS+ MARUTEX</td> <td>2.000</td> <td>PZ</td> </tr> <tr> <td>VL1178A0</td> <td>O-RING D INT 10.8 CORDA 1.78 EPDM</td> <td>2.000</td> <td>PZ</td> </tr> <tr> <td>VL1315A1</td> <td>ASM BLOCCO VASCA POMPE DID</td> <td>1.000</td> <td>PZ</td> </tr> <tr> <td>VL1332A0</td> <td>TAPPO VASCA DID</td> <td>1.000</td> <td>PZ</td> </tr> <tr> <td>VL1340A0</td> <td>ATTACCO BYPASS M-M JG10 DID</td> <td>1.000</td> <td>PZ</td> </tr> <tr> <td>VL1400A0</td> <td>CURVA SCARICO BORDO PARZIALE</td> <td>1.000</td> <td>PZ</td> </tr> <tr> <td>VL1407A1</td> <td>ASM RIDUTTORE DI</td> <td>1.000</td> <td>PZ</td> </tr> <tr> <td>VM1802A0</td> <td>PERNO ROTAZIONE SPORTELLINO TANICHE DID</td> <td>1.000</td> <td>PZ</td> </tr> <tr> <td>VM2039A0</td> <td>ANELLO FISSAGGIO CURVA DI SCARICO</td> <td>1.000</td> <td>PZ</td> </tr> <tr> <td>VM2640A0</td> <td>PROTEZIONE POMPA SCARICO</td> <td>1.000</td> <td>PZ</td> </tr> </tbody> </table>	Code	Description	Qty	UOM	RC1410A0	FASCETTA STRINGITUBO D16-27 INOX	2.000	PZ	SN1053A0	SENSORE DI LIVELLO	1.000	PZ	SN1061A0	SONDA NTC D4x175MM	1.000	PZ	TB3822A0	TB3454A-TUB O L 40 MM	1.000	PZ	TB4135A0	TB2820A-TUB O EPDM NERO L140MM	1.000	PZ	TB4160A0	TB2243A-TUB O PE TRASP D10 L150MM	1.000	PZ	VI1103A0	VITE PER PLASTICA 4X12 TPBS+ ZN-NI	6.000	PZ	VI1189A0	RONDELLA M5 INOX A4 D10 SP1	2.000	PZ	VI1220A1	VITE AUTOFIL. 4.2X11 TCS+ MARUTEX	2.000	PZ	VL1178A0	O-RING D INT 10.8 CORDA 1.78 EPDM	2.000	PZ	VL1315A1	ASM BLOCCO VASCA POMPE DID	1.000	PZ	VL1332A0	TAPPO VASCA DID	1.000	PZ	VL1340A0	ATTACCO BYPASS M-M JG10 DID	1.000	PZ	VL1400A0	CURVA SCARICO BORDO PARZIALE	1.000	PZ	VL1407A1	ASM RIDUTTORE DI	1.000	PZ	VM1802A0	PERNO ROTAZIONE SPORTELLINO TANICHE DID	1.000	PZ	VM2039A0	ANELLO FISSAGGIO CURVA DI SCARICO	1.000	PZ	VM2640A0	PROTEZIONE POMPA SCARICO	1.000	PZ
Code	Description	Qty	UOM																																																																														
RC1410A0	FASCETTA STRINGITUBO D16-27 INOX	2.000	PZ																																																																														
SN1053A0	SENSORE DI LIVELLO	1.000	PZ																																																																														
SN1061A0	SONDA NTC D4x175MM	1.000	PZ																																																																														
TB3822A0	TB3454A-TUB O L 40 MM	1.000	PZ																																																																														
TB4135A0	TB2820A-TUB O EPDM NERO L140MM	1.000	PZ																																																																														
TB4160A0	TB2243A-TUB O PE TRASP D10 L150MM	1.000	PZ																																																																														
VI1103A0	VITE PER PLASTICA 4X12 TPBS+ ZN-NI	6.000	PZ																																																																														
VI1189A0	RONDELLA M5 INOX A4 D10 SP1	2.000	PZ																																																																														
VI1220A1	VITE AUTOFIL. 4.2X11 TCS+ MARUTEX	2.000	PZ																																																																														
VL1178A0	O-RING D INT 10.8 CORDA 1.78 EPDM	2.000	PZ																																																																														
VL1315A1	ASM BLOCCO VASCA POMPE DID	1.000	PZ																																																																														
VL1332A0	TAPPO VASCA DID	1.000	PZ																																																																														
VL1340A0	ATTACCO BYPASS M-M JG10 DID	1.000	PZ																																																																														
VL1400A0	CURVA SCARICO BORDO PARZIALE	1.000	PZ																																																																														
VL1407A1	ASM RIDUTTORE DI	1.000	PZ																																																																														
VM1802A0	PERNO ROTAZIONE SPORTELLINO TANICHE DID	1.000	PZ																																																																														
VM2039A0	ANELLO FISSAGGIO CURVA DI SCARICO	1.000	PZ																																																																														
VM2640A0	PROTEZIONE POMPA SCARICO	1.000	PZ																																																																														

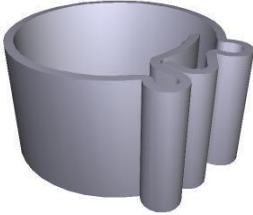

COMPONENT			SPARE PART																																																																																		
Code	Description	Image	Code	Description	Kit components																																																																																
VM2039A	ANELLO FISSAGGIO CURVA DI SCARICO		KVL1310A	COMPLETE CBX RECIRC TANK GROUP KIT	<table border="1"> <thead> <tr> <th>Code</th> <th>Description</th> <th>Qty</th> <th>UOM</th> </tr> </thead> <tbody> <tr> <td>0H5760A0</td> <td>COVER CONDENSATO RE CN1016</td> <td>1.000</td> <td>PZ</td> </tr> <tr> <td>0H6686A0</td> <td>SOSTEGNO STAFFA IDRICA DID</td> <td>1.000</td> <td>PZ</td> </tr> <tr> <td>CE2054A0</td> <td>CAVO RAST 5 POMPA DI SCARICO</td> <td>1.000</td> <td>PZ</td> </tr> <tr> <td>CE2055A0</td> <td>CAVO RAST 5 POMPA RICIRCOLO</td> <td>1.000</td> <td>PZ</td> </tr> <tr> <td>CN1016A0</td> <td>CONDENSATO RE 2.5 uF 500V CE/UL</td> <td>1.000</td> <td>PZ</td> </tr> <tr> <td>GN1400A0</td> <td>GUARNIZIONE SIFONE</td> <td>1.000</td> <td>PZ</td> </tr> <tr> <td>PM1013A0</td> <td>POMPA SCARICO 240V 32W</td> <td>1.000</td> <td>PZ</td> </tr> <tr> <td>PM1018A0</td> <td>POMPA RICIRCOLO 240V 100W</td> <td>1.000</td> <td>PZ</td> </tr> <tr> <td>RC1019A0</td> <td>FASCETTA ELASTICA D10 ZINCATA</td> <td>2.000</td> <td>PZ</td> </tr> <tr> <td>RC1046A0</td> <td>FASCETTA STRINGI TUBO D10-16 H9 INO</td> <td>1.000</td> <td>PZ</td> </tr> <tr> <td>RC1360A0</td> <td>RACCORDO GOMITO JG 10-10</td> <td>2.000</td> <td>PZ</td> </tr> <tr> <td>RC1378A0</td> <td>FASCETTA STRINGI TUBO D25-40 ZINCAT</td> <td>1.000</td> <td>PZ</td> </tr> <tr> <td>RC1410A0</td> <td>FASCETTA STRINGITUBO D16-27 INOX</td> <td>6.000</td> <td>PZ</td> </tr> <tr> <td>SN1053A0</td> <td>SENSORE DI LIVELLO</td> <td>1.000</td> <td>PZ</td> </tr> <tr> <td>SN1061A0</td> <td>SONDA NTC D4x175MM</td> <td>1.000</td> <td>PZ</td> </tr> <tr> <td>TB3822A0</td> <td>TB3454A-TUB O L 40 MM</td> <td>2.000</td> <td>PZ</td> </tr> <tr> <td>TB4135A0</td> <td>TB2820A-TUB O EPDM NERO L140MM</td> <td>1.000</td> <td>PZ</td> </tr> <tr> <td>TB4160A0</td> <td>TB2243A-TUB O PE TRASP D10 L150MM</td> <td>1.000</td> <td>PZ</td> </tr> <tr> <td>VI1103A0</td> <td>VITE PER PLASTICA 4X12 TPBS+ ZN-NI</td> <td>9.000</td> <td>PZ</td> </tr> </tbody> </table>	Code	Description	Qty	UOM	0H5760A0	COVER CONDENSATO RE CN1016	1.000	PZ	0H6686A0	SOSTEGNO STAFFA IDRICA DID	1.000	PZ	CE2054A0	CAVO RAST 5 POMPA DI SCARICO	1.000	PZ	CE2055A0	CAVO RAST 5 POMPA RICIRCOLO	1.000	PZ	CN1016A0	CONDENSATO RE 2.5 uF 500V CE/UL	1.000	PZ	GN1400A0	GUARNIZIONE SIFONE	1.000	PZ	PM1013A0	POMPA SCARICO 240V 32W	1.000	PZ	PM1018A0	POMPA RICIRCOLO 240V 100W	1.000	PZ	RC1019A0	FASCETTA ELASTICA D10 ZINCATA	2.000	PZ	RC1046A0	FASCETTA STRINGI TUBO D10-16 H9 INO	1.000	PZ	RC1360A0	RACCORDO GOMITO JG 10-10	2.000	PZ	RC1378A0	FASCETTA STRINGI TUBO D25-40 ZINCAT	1.000	PZ	RC1410A0	FASCETTA STRINGITUBO D16-27 INOX	6.000	PZ	SN1053A0	SENSORE DI LIVELLO	1.000	PZ	SN1061A0	SONDA NTC D4x175MM	1.000	PZ	TB3822A0	TB3454A-TUB O L 40 MM	2.000	PZ	TB4135A0	TB2820A-TUB O EPDM NERO L140MM	1.000	PZ	TB4160A0	TB2243A-TUB O PE TRASP D10 L150MM	1.000	PZ	VI1103A0	VITE PER PLASTICA 4X12 TPBS+ ZN-NI	9.000	PZ
Code	Description	Qty	UOM																																																																																		
0H5760A0	COVER CONDENSATO RE CN1016	1.000	PZ																																																																																		
0H6686A0	SOSTEGNO STAFFA IDRICA DID	1.000	PZ																																																																																		
CE2054A0	CAVO RAST 5 POMPA DI SCARICO	1.000	PZ																																																																																		
CE2055A0	CAVO RAST 5 POMPA RICIRCOLO	1.000	PZ																																																																																		
CN1016A0	CONDENSATO RE 2.5 uF 500V CE/UL	1.000	PZ																																																																																		
GN1400A0	GUARNIZIONE SIFONE	1.000	PZ																																																																																		
PM1013A0	POMPA SCARICO 240V 32W	1.000	PZ																																																																																		
PM1018A0	POMPA RICIRCOLO 240V 100W	1.000	PZ																																																																																		
RC1019A0	FASCETTA ELASTICA D10 ZINCATA	2.000	PZ																																																																																		
RC1046A0	FASCETTA STRINGI TUBO D10-16 H9 INO	1.000	PZ																																																																																		
RC1360A0	RACCORDO GOMITO JG 10-10	2.000	PZ																																																																																		
RC1378A0	FASCETTA STRINGI TUBO D25-40 ZINCAT	1.000	PZ																																																																																		
RC1410A0	FASCETTA STRINGITUBO D16-27 INOX	6.000	PZ																																																																																		
SN1053A0	SENSORE DI LIVELLO	1.000	PZ																																																																																		
SN1061A0	SONDA NTC D4x175MM	1.000	PZ																																																																																		
TB3822A0	TB3454A-TUB O L 40 MM	2.000	PZ																																																																																		
TB4135A0	TB2820A-TUB O EPDM NERO L140MM	1.000	PZ																																																																																		
TB4160A0	TB2243A-TUB O PE TRASP D10 L150MM	1.000	PZ																																																																																		
VI1103A0	VITE PER PLASTICA 4X12 TPBS+ ZN-NI	9.000	PZ																																																																																		

COMPONENT			SPARE PART																																																																																	
Code	Description	Image	Code	Description	Kit components																																																																															
VM2039A	ANELLO FISSAGGIO CURVA DI SCARICO		KVL1310A	COMPLETE CBX RECIRC TANK GROUP KIT	<table border="1"> <thead> <tr> <th>Code</th> <th>Description</th> <th>Qty</th> <th>UOM</th> </tr> </thead> <tbody> <tr> <td>VI1220A1</td> <td>VITE AUTOFIL. 4.2X11 TCS+ MARUTEX</td> <td>2.000</td> <td>PZ</td> </tr> <tr> <td>VI1931A0</td> <td>DADO CONDENSATO RE M8x1.65 H4 CH13 ZINC</td> <td>1.000</td> <td>PZ</td> </tr> <tr> <td>VL1178A0</td> <td>O-RING D INT 10.8 CORDA 1.78 EPDM</td> <td>2.000</td> <td>PZ</td> </tr> <tr> <td>VL1315A1</td> <td>ASM BLOCCO VASCA POMPE DID</td> <td>1.000</td> <td>PZ</td> </tr> <tr> <td>VL1318A1</td> <td>SUPPORTO POMPA RICIRCOLO CBX</td> <td>1.000</td> <td>PZ</td> </tr> <tr> <td>VL1329A0</td> <td>RACCORDO D24-D16</td> <td>1.000</td> <td>PZ</td> </tr> <tr> <td>VL1332A0</td> <td>TAPPO VASCA DID</td> <td>1.000</td> <td>PZ</td> </tr> <tr> <td>VL1340A0</td> <td>ATTACCO BYPASS M-M JG10 DID</td> <td>1.000</td> <td>PZ</td> </tr> <tr> <td>VL1400A0</td> <td>CURVA SCARICO BORDO PARZIALE</td> <td>1.000</td> <td>PZ</td> </tr> <tr> <td>VL1407A1</td> <td>ASM RIDUTTORE DI</td> <td>1.000</td> <td>PZ</td> </tr> <tr> <td>VM1794A0</td> <td>FASCETTA 430X4.8 PA66 NERA</td> <td>1.000</td> <td>PZ</td> </tr> <tr> <td>VM1802A0</td> <td>PERNO ROTAZIONE SPORTELLINO TANICHE DID</td> <td>1.000</td> <td>PZ</td> </tr> <tr> <td>VM2039A0</td> <td>ANELLO FISSAGGIO CURVA DI SCARICO</td> <td>1.000</td> <td>PZ</td> </tr> <tr> <td>VM2640A0</td> <td>PROTEZIONE POMPA SCARICO</td> <td>1.000</td> <td>PZ</td> </tr> </tbody> </table>	Code	Description	Qty	UOM	VI1220A1	VITE AUTOFIL. 4.2X11 TCS+ MARUTEX	2.000	PZ	VI1931A0	DADO CONDENSATO RE M8x1.65 H4 CH13 ZINC	1.000	PZ	VL1178A0	O-RING D INT 10.8 CORDA 1.78 EPDM	2.000	PZ	VL1315A1	ASM BLOCCO VASCA POMPE DID	1.000	PZ	VL1318A1	SUPPORTO POMPA RICIRCOLO CBX	1.000	PZ	VL1329A0	RACCORDO D24-D16	1.000	PZ	VL1332A0	TAPPO VASCA DID	1.000	PZ	VL1340A0	ATTACCO BYPASS M-M JG10 DID	1.000	PZ	VL1400A0	CURVA SCARICO BORDO PARZIALE	1.000	PZ	VL1407A1	ASM RIDUTTORE DI	1.000	PZ	VM1794A0	FASCETTA 430X4.8 PA66 NERA	1.000	PZ	VM1802A0	PERNO ROTAZIONE SPORTELLINO TANICHE DID	1.000	PZ	VM2039A0	ANELLO FISSAGGIO CURVA DI SCARICO	1.000	PZ	VM2640A0	PROTEZIONE POMPA SCARICO	1.000	PZ	KVL1026A	DRAIN PIPE BEND KI	<table border="1"> <thead> <tr> <th>Code</th> <th>Description</th> <th>Qty</th> <th>UOM</th> </tr> </thead> <tbody> <tr> <td>GN1400A0</td> <td>GUARNIZIONE SIFONE</td> <td>1.000</td> <td>PZ</td> </tr> <tr> <td>VL1026A0</td> <td>CURVA PER TUBO DI SCARICO</td> <td>1.000</td> <td>PZ</td> </tr> <tr> <td>VM2039A0</td> <td>ANELLO FISSAGGIO CURVA DI SCARICO</td> <td>1.000</td> <td>PZ</td> </tr> </tbody> </table>	Code	Description	Qty	UOM	GN1400A0	GUARNIZIONE SIFONE	1.000	PZ	VL1026A0	CURVA PER TUBO DI SCARICO	1.000	PZ	VM2039A0	ANELLO FISSAGGIO CURVA DI SCARICO	1.000	PZ
			Code	Description	Qty	UOM																																																																														
VI1220A1	VITE AUTOFIL. 4.2X11 TCS+ MARUTEX	2.000	PZ																																																																																	
VI1931A0	DADO CONDENSATO RE M8x1.65 H4 CH13 ZINC	1.000	PZ																																																																																	
VL1178A0	O-RING D INT 10.8 CORDA 1.78 EPDM	2.000	PZ																																																																																	
VL1315A1	ASM BLOCCO VASCA POMPE DID	1.000	PZ																																																																																	
VL1318A1	SUPPORTO POMPA RICIRCOLO CBX	1.000	PZ																																																																																	
VL1329A0	RACCORDO D24-D16	1.000	PZ																																																																																	
VL1332A0	TAPPO VASCA DID	1.000	PZ																																																																																	
VL1340A0	ATTACCO BYPASS M-M JG10 DID	1.000	PZ																																																																																	
VL1400A0	CURVA SCARICO BORDO PARZIALE	1.000	PZ																																																																																	
VL1407A1	ASM RIDUTTORE DI	1.000	PZ																																																																																	
VM1794A0	FASCETTA 430X4.8 PA66 NERA	1.000	PZ																																																																																	
VM1802A0	PERNO ROTAZIONE SPORTELLINO TANICHE DID	1.000	PZ																																																																																	
VM2039A0	ANELLO FISSAGGIO CURVA DI SCARICO	1.000	PZ																																																																																	
VM2640A0	PROTEZIONE POMPA SCARICO	1.000	PZ																																																																																	
Code	Description	Qty	UOM																																																																																	
GN1400A0	GUARNIZIONE SIFONE	1.000	PZ																																																																																	
VL1026A0	CURVA PER TUBO DI SCARICO	1.000	PZ																																																																																	
VM2039A0	ANELLO FISSAGGIO CURVA DI SCARICO	1.000	PZ																																																																																	

COMPONENT			SPARE PART																		
Code	Description	Image	Code	Description	Kit components																
VM1555A	SUPPORTO VENTOLA RAFFREDDAMENTO CT BT		KVN1165A	S.5E ADVANCE/MM 230V COOLING FAN KIT	<table border="1"> <thead> <tr> <th>Code</th> <th>Description</th> <th>Qty</th> <th>UOM</th> </tr> </thead> <tbody> <tr> <td>VI1099A0</td> <td>VITE AUTOFORANT E 4.8X13 TCB+ ZN</td> <td>4.000</td> <td>PZ</td> </tr> <tr> <td>VM1555A2</td> <td>SUPPORTO VENTOLA RAFFREDDAM ENTO CT BT</td> <td>1.000</td> <td>PZ</td> </tr> <tr> <td>VN1165A0</td> <td>VENTOLA RAFFREDDAM ENTO 230Vac 50/60Hz 12</td> <td>1.000</td> <td>PZ</td> </tr> </tbody> </table>	Code	Description	Qty	UOM	VI1099A0	VITE AUTOFORANT E 4.8X13 TCB+ ZN	4.000	PZ	VM1555A2	SUPPORTO VENTOLA RAFFREDDAM ENTO CT BT	1.000	PZ	VN1165A0	VENTOLA RAFFREDDAM ENTO 230Vac 50/60Hz 12	1.000	PZ
			Code	Description	Qty	UOM															
VI1099A0	VITE AUTOFORANT E 4.8X13 TCB+ ZN	4.000	PZ																		
VM1555A2	SUPPORTO VENTOLA RAFFREDDAM ENTO CT BT	1.000	PZ																		
VN1165A0	VENTOLA RAFFREDDAM ENTO 230Vac 50/60Hz 12	1.000	PZ																		
KVN1164A	S.5/5E 12VDC COOLING DOWN FAN KIT	<table border="1"> <thead> <tr> <th>Code</th> <th>Description</th> <th>Qty</th> <th>UOM</th> </tr> </thead> <tbody> <tr> <td>VI1099A0</td> <td>VITE AUTOFORANT E 4.8X13 TCB+ ZN</td> <td>4.000</td> <td>PZ</td> </tr> <tr> <td>VM1555A2</td> <td>SUPPORTO VENTOLA RAFFREDDAM ENTO CT BT</td> <td>1.000</td> <td>PZ</td> </tr> <tr> <td>VN1164A0</td> <td>VENTOLA RAFFREDDAM ENTO 12VDC</td> <td>1.000</td> <td>PZ</td> </tr> </tbody> </table>	Code	Description	Qty	UOM	VI1099A0	VITE AUTOFORANT E 4.8X13 TCB+ ZN	4.000	PZ	VM1555A2	SUPPORTO VENTOLA RAFFREDDAM ENTO CT BT	1.000	PZ	VN1164A0	VENTOLA RAFFREDDAM ENTO 12VDC	1.000	PZ			
Code	Description	Qty	UOM																		
VI1099A0	VITE AUTOFORANT E 4.8X13 TCB+ ZN	4.000	PZ																		
VM1555A2	SUPPORTO VENTOLA RAFFREDDAM ENTO CT BT	1.000	PZ																		
VN1164A0	VENTOLA RAFFREDDAM ENTO 12VDC	1.000	PZ																		
VM1556A	PROTEZIONE VENTOLA RAFFREDAMENTO CT BT		KVM1556A	XBC-XVC COOLING FAN GUARD KIT	<table border="1"> <thead> <tr> <th>Code</th> <th>Description</th> <th>Qty</th> <th>UOM</th> </tr> </thead> <tbody> <tr> <td>VM1556A0</td> <td>PROTEZIONE VENTOLA RAFFREDAME NTO CT BT</td> <td>1.000</td> <td>PZ</td> </tr> </tbody> </table>	Code	Description	Qty	UOM	VM1556A0	PROTEZIONE VENTOLA RAFFREDAME NTO CT BT	1.000	PZ								
Code	Description	Qty	UOM																		
VM1556A0	PROTEZIONE VENTOLA RAFFREDAME NTO CT BT	1.000	PZ																		
VN1165A	VENTOLA RAFFREDDAMENTO 230Vac 50/60Hz 12		KVN1165A	S.5E ADVANCE/MM 230V COOLING FAN KIT	<table border="1"> <thead> <tr> <th>Code</th> <th>Description</th> <th>Qty</th> <th>UOM</th> </tr> </thead> <tbody> <tr> <td>VI1099A0</td> <td>VITE AUTOFORANT E 4.8X13 TCB+ ZN</td> <td>4.000</td> <td>PZ</td> </tr> <tr> <td>VM1555A2</td> <td>SUPPORTO VENTOLA RAFFREDDAM ENTO CT BT</td> <td>1.000</td> <td>PZ</td> </tr> <tr> <td>VN1165A0</td> <td>VENTOLA RAFFREDDAM ENTO 230Vac 50/60Hz 12</td> <td>1.000</td> <td>PZ</td> </tr> </tbody> </table>	Code	Description	Qty	UOM	VI1099A0	VITE AUTOFORANT E 4.8X13 TCB+ ZN	4.000	PZ	VM1555A2	SUPPORTO VENTOLA RAFFREDDAM ENTO CT BT	1.000	PZ	VN1165A0	VENTOLA RAFFREDDAM ENTO 230Vac 50/60Hz 12	1.000	PZ
			Code	Description	Qty	UOM															
			VI1099A0	VITE AUTOFORANT E 4.8X13 TCB+ ZN	4.000	PZ															
VM1555A2	SUPPORTO VENTOLA RAFFREDDAM ENTO CT BT	1.000	PZ																		
VN1165A0	VENTOLA RAFFREDDAM ENTO 230Vac 50/60Hz 12	1.000	PZ																		

COMPONENT			SPARE PART																																		
Code	Description	Image	Code	Description	Kit components																																
EL1438A	ELETTRORVALVOLA VAPORE 5+9 BARBE		KEL1438A	5+9 BARBED 6 STEAM SOLENOID VALVE KIT	<table border="1"> <thead> <tr> <th>Code</th> <th>Description</th> <th>Qty</th> <th>UOM</th> </tr> </thead> <tbody> <tr> <td>EL1438A0</td> <td>ELETTRORVALV OLA VAPORE 5+9 BARBED</td> <td>1.000</td> <td>PZ</td> </tr> <tr> <td>RC1414A1</td> <td>FASCETTA STRINGITUBO A SCATTO D11.5-12.5</td> <td>2.000</td> <td>PZ</td> </tr> </tbody> </table>	Code	Description	Qty	UOM	EL1438A0	ELETTRORVALV OLA VAPORE 5+9 BARBED	1.000	PZ	RC1414A1	FASCETTA STRINGITUBO A SCATTO D11.5-12.5	2.000	PZ																				
Code	Description	Qty	UOM																																		
EL1438A0	ELETTRORVALV OLA VAPORE 5+9 BARBED	1.000	PZ																																		
RC1414A1	FASCETTA STRINGITUBO A SCATTO D11.5-12.5	2.000	PZ																																		
RC1414A	FASCETTA STRINGITUBO A SCATTO D11.5-12.5		KRC1414A	D11-12 HOSE SNAP CLAMP 50 PCS KIT	<table border="1"> <thead> <tr> <th>Code</th> <th>Description</th> <th>Qty</th> <th>UOM</th> </tr> </thead> <tbody> <tr> <td>RC1414A1</td> <td>FASCETTA STRINGITUBO A SCATTO D11.5-12.5</td> <td>50.000</td> <td>PZ</td> </tr> </tbody> </table>	Code	Description	Qty	UOM	RC1414A1	FASCETTA STRINGITUBO A SCATTO D11.5-12.5	50.000	PZ																								
Code	Description	Qty	UOM																																		
RC1414A1	FASCETTA STRINGITUBO A SCATTO D11.5-12.5	50.000	PZ																																		
TB2869A	TB2869A0		KTB3131A	WHITE-BLACK 6X12 STEAM PIPE 3M KIT	<table border="1"> <thead> <tr> <th>Code</th> <th>Description</th> <th>Qty</th> <th>UOM</th> </tr> </thead> <tbody> <tr> <td>TB3131A0</td> <td>TUBO TELATO EPDM BIANCO-NERO 6X12</td> <td>3.000</td> <td>M</td> </tr> <tr> <td>VM1794A0</td> <td>FASCETTA 430X4.8 PA66 NERA</td> <td>1.000</td> <td>PZ</td> </tr> </tbody> </table>	Code	Description	Qty	UOM	TB3131A0	TUBO TELATO EPDM BIANCO-NERO 6X12	3.000	M	VM1794A0	FASCETTA 430X4.8 PA66 NERA	1.000	PZ																				
Code	Description	Qty	UOM																																		
TB3131A0	TUBO TELATO EPDM BIANCO-NERO 6X12	3.000	M																																		
VM1794A0	FASCETTA 430X4.8 PA66 NERA	1.000	PZ																																		
VL1183A	ASM LAVAGGIO PLUS MONO GIRANTE		KVL1183A	1 ROTOR ARM PLUS CLEANING SYSTEM KIT	<table border="1"> <thead> <tr> <th>Code</th> <th>Description</th> <th>Qty</th> <th>UOM</th> </tr> </thead> <tbody> <tr> <td>0H2354A2</td> <td>LAMIERA IMPIANTO LAVAGGIO PLUS XEVC-XEVL</td> <td>1.000</td> <td>PZ</td> </tr> <tr> <td>EL1346A0</td> <td>CLIP BLOCCA PINZETTA RACCORDI D10 TIERRE</td> <td>2.000</td> <td>PZ</td> </tr> <tr> <td>EL1440A0</td> <td>ELETTRORVALV OLA H2O AUTOPULENT E BAF EU</td> <td>3.000</td> <td>PZ</td> </tr> <tr> <td>GN1526A0</td> <td>O-RING D.INT6.9 SP1.8</td> <td>7.000</td> <td>PZ</td> </tr> <tr> <td>RC1018A0</td> <td>FASCETTA ELASTICA D12 ZINCATA</td> <td>1.000</td> <td>PZ</td> </tr> <tr> <td>RC1019A0</td> <td>FASCETTA ELASTICA D10 ZINCATA</td> <td>12.000</td> <td>PZ</td> </tr> <tr> <td>RC1130A0</td> <td>FASCETTA 130X2,6</td> <td>1.000</td> <td>PZ</td> </tr> </tbody> </table>	Code	Description	Qty	UOM	0H2354A2	LAMIERA IMPIANTO LAVAGGIO PLUS XEVC-XEVL	1.000	PZ	EL1346A0	CLIP BLOCCA PINZETTA RACCORDI D10 TIERRE	2.000	PZ	EL1440A0	ELETTRORVALV OLA H2O AUTOPULENT E BAF EU	3.000	PZ	GN1526A0	O-RING D.INT6.9 SP1.8	7.000	PZ	RC1018A0	FASCETTA ELASTICA D12 ZINCATA	1.000	PZ	RC1019A0	FASCETTA ELASTICA D10 ZINCATA	12.000	PZ	RC1130A0	FASCETTA 130X2,6	1.000	PZ
Code	Description	Qty	UOM																																		
0H2354A2	LAMIERA IMPIANTO LAVAGGIO PLUS XEVC-XEVL	1.000	PZ																																		
EL1346A0	CLIP BLOCCA PINZETTA RACCORDI D10 TIERRE	2.000	PZ																																		
EL1440A0	ELETTRORVALV OLA H2O AUTOPULENT E BAF EU	3.000	PZ																																		
GN1526A0	O-RING D.INT6.9 SP1.8	7.000	PZ																																		
RC1018A0	FASCETTA ELASTICA D12 ZINCATA	1.000	PZ																																		
RC1019A0	FASCETTA ELASTICA D10 ZINCATA	12.000	PZ																																		
RC1130A0	FASCETTA 130X2,6	1.000	PZ																																		

COMPONENT			SPARE PART					
Code	Description	Image	Code	Description	Kit components			
VL1183A	ASM LAVAGGIO PLUS MONO GIRANTE		KVL1183A	1 ROTOR ARM PLUS CLEANING SYSTEM KIT	Code	Description	Qty	UOM
					RC1131A0	FASCETTA 200X2,6 BIANC	2.000	PZ
					RC1242A0	TERMINALE CHIUSO D10	2.000	PZ
					RC1356A0	RACCORDO FEMM 8X1/4 BSP	1.000	PZ
					RC1414A1	FASCETTA STRINGITUBO A SCATTO D11,5-12,5	4.000	PZ
					TB2821A0	TB2820A-L=40 MM EPDM NER	4.000	PZ
					TB3004A0	TB2820A-L=57 0MM EPDM NERO	1.000	PZ
					TB3252A0	TB3132A-L=23 0MM EPDM BIANCO BLU	1.000	PZ
					TB3614A0	TB2820A-L=96 MM NERO EPD	1.000	PZ
					TB5360A0	TB3132A-TUB O EPDM TELATO BIANCO-BLU 550M	1.000	PZ
					TB5362A0	TB3132A-TUB O EPDM TELATO BIANCO-BLU 230M	1.000	PZ
					VI1220A1	VITE AUTOFIL. 4.2X11 TCS+ MARUTEX	1.000	PZ
					VL1019A0	POMPA DETERGENTE VIBRAZIONE	1.000	PZ
					VL1047A1	PORTAGOMM A D6 CODOLO D8	1.000	PZ
					VL1102A1	FILTRO IN LINEA DET. + VNR BARBED 6 MM	1.000	PZ
					VL1128A1	VALVOLA VNR BARBED D6	1.000	PZ
					VL1166A0	RACCORDO A L BAM-BB6	3.000	PZ
					VL1174C0	UGELLO CALIBRATO D1.2 MM	1.000	PZ

COMPONENT			SPARE PART																																														
Code	Description	Image	Code	Description	Kit components																																												
VL1183A	ASM LAVAGGIO PLUS MONO GIRANTE		KVL1183A	1 ROTOR ARM PLUS CLEANING SYSTEM KIT	<table border="1"> <thead> <tr> <th>Code</th> <th>Description</th> <th>Qty</th> <th>UOM</th> </tr> </thead> <tbody> <tr> <td>VL1185A0</td> <td>DISTRIBUTOR E LAVAGGIO PLUS 2 VIE UGELLO</td> <td>1.000</td> <td>PZ</td> </tr> <tr> <td>VL1190A0</td> <td>DISTRIBUTOR E INGRESSI LAVAGGIO PLUS</td> <td>1.000</td> <td>PZ</td> </tr> <tr> <td>VL1214A0</td> <td>VALVOLA VNR BB6-BAIONET TA</td> <td>1.000</td> <td>PZ</td> </tr> <tr> <td>VL1398A0</td> <td>PRESSOSTAT O.N.O. 1/4 M CI</td> <td>1.000</td> <td>PZ</td> </tr> <tr> <td>VM1605A0</td> <td>CLIP TWIST LOCK DIAM. 10,2-12,7 MM</td> <td>3.000</td> <td>PZ</td> </tr> <tr> <td>VM2172A0</td> <td>CLIP BLOCCAGGIO POMPA CON CIRCUITO</td> <td>4.000</td> <td>PZ</td> </tr> </tbody> </table>	Code	Description	Qty	UOM	VL1185A0	DISTRIBUTOR E LAVAGGIO PLUS 2 VIE UGELLO	1.000	PZ	VL1190A0	DISTRIBUTOR E INGRESSI LAVAGGIO PLUS	1.000	PZ	VL1214A0	VALVOLA VNR BB6-BAIONET TA	1.000	PZ	VL1398A0	PRESSOSTAT O.N.O. 1/4 M CI	1.000	PZ	VM1605A0	CLIP TWIST LOCK DIAM. 10,2-12,7 MM	3.000	PZ	VM2172A0	CLIP BLOCCAGGIO POMPA CON CIRCUITO	4.000	PZ																
					Code	Description	Qty	UOM																																									
VL1185A0	DISTRIBUTOR E LAVAGGIO PLUS 2 VIE UGELLO	1.000	PZ																																														
VL1190A0	DISTRIBUTOR E INGRESSI LAVAGGIO PLUS	1.000	PZ																																														
VL1214A0	VALVOLA VNR BB6-BAIONET TA	1.000	PZ																																														
VL1398A0	PRESSOSTAT O.N.O. 1/4 M CI	1.000	PZ																																														
VM1605A0	CLIP TWIST LOCK DIAM. 10,2-12,7 MM	3.000	PZ																																														
VM2172A0	CLIP BLOCCAGGIO POMPA CON CIRCUITO	4.000	PZ																																														
0H2354A	LAMIERA IMPIANTO LAVAGGIO PLUS XEVC-XEVL		KVL1209A	US PLUS 3 ROTOR ARMS WASHING SYSTEM KIT	<table border="1"> <thead> <tr> <th>Code</th> <th>Description</th> <th>Qty</th> <th>UOM</th> </tr> </thead> <tbody> <tr> <td>0H2354A2</td> <td>LAMIERA IMPIANTO LAVAGGIO PLUS XEVC-XEVL</td> <td>1.000</td> <td>PZ</td> </tr> <tr> <td>EL1346A0</td> <td>CLIP BLOCCA PINZETTA RACCORDI D10 TIERRE</td> <td>2.000</td> <td>PZ</td> </tr> <tr> <td>EL1450A0</td> <td>ELETTROVALVOLA H2O AUTOPULENT E BAF USA</td> <td>4.000</td> <td>PZ</td> </tr> <tr> <td>GN1526A0</td> <td>O-RING D.INT6.9 SP1.8</td> <td>9.000</td> <td>PZ</td> </tr> <tr> <td>RC1018A0</td> <td>FASCETTA ELASTICA D12 ZINCATA</td> <td>11.000</td> <td>PZ</td> </tr> <tr> <td>RC1019A0</td> <td>FASCETTA ELASTICA D10 ZINCATA</td> <td>14.000</td> <td>PZ</td> </tr> <tr> <td>RC1130A0</td> <td>FASCETTA 130X2,6</td> <td>1.000</td> <td>PZ</td> </tr> <tr> <td>RC1131A0</td> <td>FASCETTA 200X2,6 BIANC</td> <td>3.000</td> <td>PZ</td> </tr> <tr> <td>RC1242A0</td> <td>TERMINALE CHIUSO D10</td> <td>2.000</td> <td>PZ</td> </tr> <tr> <td>RC1356A0</td> <td>RACCORDO DRITTO FIL. FEMM 8X1/4 BSP</td> <td>1.000</td> <td>PZ</td> </tr> </tbody> </table>	Code	Description	Qty	UOM	0H2354A2	LAMIERA IMPIANTO LAVAGGIO PLUS XEVC-XEVL	1.000	PZ	EL1346A0	CLIP BLOCCA PINZETTA RACCORDI D10 TIERRE	2.000	PZ	EL1450A0	ELETTROVALVOLA H2O AUTOPULENT E BAF USA	4.000	PZ	GN1526A0	O-RING D.INT6.9 SP1.8	9.000	PZ	RC1018A0	FASCETTA ELASTICA D12 ZINCATA	11.000	PZ	RC1019A0	FASCETTA ELASTICA D10 ZINCATA	14.000	PZ	RC1130A0	FASCETTA 130X2,6	1.000	PZ	RC1131A0	FASCETTA 200X2,6 BIANC	3.000	PZ	RC1242A0	TERMINALE CHIUSO D10	2.000	PZ	RC1356A0	RACCORDO DRITTO FIL. FEMM 8X1/4 BSP	1.000	PZ
					Code	Description	Qty	UOM																																									
0H2354A2	LAMIERA IMPIANTO LAVAGGIO PLUS XEVC-XEVL	1.000	PZ																																														
EL1346A0	CLIP BLOCCA PINZETTA RACCORDI D10 TIERRE	2.000	PZ																																														
EL1450A0	ELETTROVALVOLA H2O AUTOPULENT E BAF USA	4.000	PZ																																														
GN1526A0	O-RING D.INT6.9 SP1.8	9.000	PZ																																														
RC1018A0	FASCETTA ELASTICA D12 ZINCATA	11.000	PZ																																														
RC1019A0	FASCETTA ELASTICA D10 ZINCATA	14.000	PZ																																														
RC1130A0	FASCETTA 130X2,6	1.000	PZ																																														
RC1131A0	FASCETTA 200X2,6 BIANC	3.000	PZ																																														
RC1242A0	TERMINALE CHIUSO D10	2.000	PZ																																														
RC1356A0	RACCORDO DRITTO FIL. FEMM 8X1/4 BSP	1.000	PZ																																														

COMPONENT			SPARE PART					
Code	Description	Image	Code	Description	Kit components			
0H2354A	LAMIERA IMPIANTO LAVAGGIO PLUS XEVC-XEVL		KVL1209A	US PLUS 3 ROTOR ARMS WASHING SYSTEM KIT	Code	Description	Qty	UOM
					RC1414A1	FASCETTA STRINGITUBO A SCATTO D11.5-12.5	1.000	PZ
					TB2652A0	TB3132A-L750 MM BIANCO BLU EPDM	1.000	PZ
					TB2677A0	TB2820A-TUB O TANICA DET-FDET L1300MM	1.000	PZ
					TB2821A0	TB2820A-L=40 MM EPDM NER	4.000	PZ
					TB3004A0	TB2820A-L=57 0MM EPDM NERO	2.000	PZ
					TB3024C0	TB3132A-TUB O BLU 6X12 L=55MM	3.000	PZ
					TB3226A0	TB2820A-L110 MM COLLEGAMEN TO TANICA-LA	1.000	PZ
					TB3440A0	TB3132A-L=10 50MM EPDM BIANCO-BLU	1.000	PZ
					TB3614A0	TB2820A-L=96 MM NERO EPD	1.000	PZ
					VH1220A1	VITE AUTOFIL. 4.2X11 TCS+ MARUTEX	1.000	PZ
					VL1019A0	POMPA DETERGENTE VIBRAZIONE	1.000	PZ
					VL1102A1	FILTRO IN LINEA DET. + VNR BARBED 6 MM	1.000	PZ
					VL1127A1	RACCORDO A T BARBED 6	2.000	PZ
					VL1128A1	VALVOLA VNR BARBED D6	2.000	PZ
					VL1166A0	RACCORDO A L BAM-BB6	4.000	PZ
					VL1167A2	FLOW RESTRICTOR 3 GIRANTI GN21 B-B	1.000	PZ
					VL1174C0	UGELLO CALIBRATO D1.2 MM	1.000	PZ
					VL1186A0	DISTRIBUTOR PLUS 3 VIE UGELLO	1.000	PZ

COMPONENT			SPARE PART																																																			
Code	Description	Image	Code	Description	Kit components																																																	
0H2354A	LAMIERA IMPIANTO LAVAGGIO PLUS XEVC-XEVL		KVL1209A	US PLUS 3 ROTOR ARMS WASHING SYSTEM KIT	<table border="1"> <thead> <tr> <th>Code</th> <th>Description</th> <th>Qty</th> <th>UOM</th> </tr> </thead> <tbody> <tr> <td>VL1190A0</td> <td>DISTRIBUTOR E INGRESSI LAVAGGIO PLUS</td> <td>1.000</td> <td>PZ</td> </tr> <tr> <td>VL1214A0</td> <td>VALVOLA VNR BB6-BAIONET TA</td> <td>1.000</td> <td>PZ</td> </tr> <tr> <td>VL1398A0</td> <td>PRESSOSTAT O.N.O. 1/4 M CI</td> <td>1.000</td> <td>PZ</td> </tr> <tr> <td>VM1605A0</td> <td>CLIP TWIST LOCK DIAM. 10,2-12,7 MM</td> <td>3.000</td> <td>PZ</td> </tr> <tr> <td>VM2172A0</td> <td>CLIP BLOCCAGGIO POMPA CON CIRCUITO</td> <td>5.000</td> <td>PZ</td> </tr> </tbody> </table>	Code	Description	Qty	UOM	VL1190A0	DISTRIBUTOR E INGRESSI LAVAGGIO PLUS	1.000	PZ	VL1214A0	VALVOLA VNR BB6-BAIONET TA	1.000	PZ	VL1398A0	PRESSOSTAT O.N.O. 1/4 M CI	1.000	PZ	VM1605A0	CLIP TWIST LOCK DIAM. 10,2-12,7 MM	3.000	PZ	VM2172A0	CLIP BLOCCAGGIO POMPA CON CIRCUITO	5.000	PZ																									
			Code	Description	Qty	UOM																																																
VL1190A0	DISTRIBUTOR E INGRESSI LAVAGGIO PLUS	1.000	PZ																																																			
VL1214A0	VALVOLA VNR BB6-BAIONET TA	1.000	PZ																																																			
VL1398A0	PRESSOSTAT O.N.O. 1/4 M CI	1.000	PZ																																																			
VM1605A0	CLIP TWIST LOCK DIAM. 10,2-12,7 MM	3.000	PZ																																																			
VM2172A0	CLIP BLOCCAGGIO POMPA CON CIRCUITO	5.000	PZ																																																			
KVL1208A	US PLUS 2 ROTOR ARMS WASHING SYSTEM KIT	<table border="1"> <thead> <tr> <th>Code</th> <th>Description</th> <th>Qty</th> <th>UOM</th> </tr> </thead> <tbody> <tr> <td>0H2354A2</td> <td>LAMIERA IMPIANTO LAVAGGIO PLUS XEVC-XEVL</td> <td>1.000</td> <td>PZ</td> </tr> <tr> <td>EL1346A0</td> <td>CLIP BLOCCA PINZETTA RACCORDI D10 TIERRE</td> <td>2.000</td> <td>PZ</td> </tr> <tr> <td>EL1450A0</td> <td>ELETTROVALV OLA H2O AUTOPULENT E BAF USA</td> <td>4.000</td> <td>PZ</td> </tr> <tr> <td>GN1526A0</td> <td>O-RING D.INT6.9 SP1.8</td> <td>9.000</td> <td>PZ</td> </tr> <tr> <td>RC1018A0</td> <td>FASCETTA ELASTICA D12 ZINCATA</td> <td>3.000</td> <td>PZ</td> </tr> <tr> <td>RC1019A0</td> <td>FASCETTA ELASTICA D10 ZINCATA</td> <td>2.000</td> <td>PZ</td> </tr> <tr> <td>RC1130A0</td> <td>FASCETTA 130X2,6</td> <td>1.000</td> <td>PZ</td> </tr> <tr> <td>RC1131A0</td> <td>FASCETTA 200X2,6 BIANC</td> <td>3.000</td> <td>PZ</td> </tr> <tr> <td>RC1242A0</td> <td>TERMINALE CHIUSO D10</td> <td>2.000</td> <td>PZ</td> </tr> <tr> <td>RC1356A0</td> <td>RACCORDO DRITTO FIL. FEMM 8X1/4 BSP</td> <td>1.000</td> <td>PZ</td> </tr> <tr> <td>RC1414A1</td> <td>FASCETTA STRINGITUBO A SCATTO D11.5-12.5</td> <td>4.000</td> <td>PZ</td> </tr> <tr> <td>TB2821A0</td> <td>TB2820A-L=40 MM EPDM NER</td> <td>6.000</td> <td>PZ</td> </tr> </tbody> </table>	Code	Description	Qty	UOM	0H2354A2	LAMIERA IMPIANTO LAVAGGIO PLUS XEVC-XEVL	1.000	PZ	EL1346A0	CLIP BLOCCA PINZETTA RACCORDI D10 TIERRE	2.000	PZ	EL1450A0	ELETTROVALV OLA H2O AUTOPULENT E BAF USA	4.000	PZ	GN1526A0	O-RING D.INT6.9 SP1.8	9.000	PZ	RC1018A0	FASCETTA ELASTICA D12 ZINCATA	3.000	PZ	RC1019A0	FASCETTA ELASTICA D10 ZINCATA	2.000	PZ	RC1130A0	FASCETTA 130X2,6	1.000	PZ	RC1131A0	FASCETTA 200X2,6 BIANC	3.000	PZ	RC1242A0	TERMINALE CHIUSO D10	2.000	PZ	RC1356A0	RACCORDO DRITTO FIL. FEMM 8X1/4 BSP	1.000	PZ	RC1414A1	FASCETTA STRINGITUBO A SCATTO D11.5-12.5	4.000	PZ	TB2821A0	TB2820A-L=40 MM EPDM NER	6.000	PZ
Code	Description	Qty	UOM																																																			
0H2354A2	LAMIERA IMPIANTO LAVAGGIO PLUS XEVC-XEVL	1.000	PZ																																																			
EL1346A0	CLIP BLOCCA PINZETTA RACCORDI D10 TIERRE	2.000	PZ																																																			
EL1450A0	ELETTROVALV OLA H2O AUTOPULENT E BAF USA	4.000	PZ																																																			
GN1526A0	O-RING D.INT6.9 SP1.8	9.000	PZ																																																			
RC1018A0	FASCETTA ELASTICA D12 ZINCATA	3.000	PZ																																																			
RC1019A0	FASCETTA ELASTICA D10 ZINCATA	2.000	PZ																																																			
RC1130A0	FASCETTA 130X2,6	1.000	PZ																																																			
RC1131A0	FASCETTA 200X2,6 BIANC	3.000	PZ																																																			
RC1242A0	TERMINALE CHIUSO D10	2.000	PZ																																																			
RC1356A0	RACCORDO DRITTO FIL. FEMM 8X1/4 BSP	1.000	PZ																																																			
RC1414A1	FASCETTA STRINGITUBO A SCATTO D11.5-12.5	4.000	PZ																																																			
TB2821A0	TB2820A-L=40 MM EPDM NER	6.000	PZ																																																			

COMPONENT			SPARE PART					
Code	Description	Image	Code	Description	Kit components			
0H2354A	LAMIERA IMPIANTO LAVAGGIO PLUS XEVC-XEVL		KVL1208A	US PLUS 2 ROTOR ARMS WASHING SYSTEM KIT	Code	Description	Qty	UOM
					TB2994A0	TB2820A-TUB O EPDM NERO 1000MM	1.000	PZ
					TB3004A0	TB2820A-L=57 0MM EPDM NERO	2.000	PZ
					TB3005B0	TB3132A-L=55 0MM EPDM BIANCO BLU	1.000	PZ
					TB3440A0	TB3132A-L=10 50MM EPDM BIANCO-BLU	1.000	PZ
					VL1019A0	POMPA DETERGENTE VIBRAZIONE	1.000	PZ
					VL1047A1	PORTAGOMM A D6 CODOLO D8	1.000	PZ
					VL1102A1	FILTRO IN LINEA DET. + VNR BARBED 6 MM	1.000	PZ
					VL1128A1	VALVOLA VNR BARBED D6	2.000	PZ
					VL1141A1	RACCORDO DRITTO BB6-BB6	1.000	PZ
					VL1166A0	RACCORDO A L BAM-BB6	4.000	PZ
					VL1174C0	UGELLO CALIBRATO D1.2 MM	1.000	PZ
					VL1186A0	DISTRIBUTOR E LAVAGGIO PLUS 3 VIE UGELLO	1.000	PZ
					VL1190A0	DISTRIBUTOR E INGRESSI LAVAGGIO PLUS	1.000	PZ
					VL1214A0	VALVOLA VNR BB6-BAIONET TA	1.000	PZ
					VL1398A0	PRESSOSTAT O N.O. 1/4 M CI	1.000	PZ
					VM1605A0	CLIP TWIST LOCK DIAM. 10,2-12,7 MM	3.000	PZ
					VM2172A0	CLIP BLOCCAGGIO POMPA CON CIRCUITO	5.000	PZ

COMPONENT			SPARE PART					
Code	Description	Image	Code	Description	Kit components			
0H2354A	LAMIERA IMPIANTO LAVAGGIO PLUS XEVC-XEVL		KVL1207A	US PLUS 1 ROTOR ARM WASHING SYSTEM KIT	Code	Description	Qty	UOM
					0H2354A2	LAMIERA IMPIANTO LAVAGGIO PLUS XEVC-XEVL	1.000	PZ
					EL1346A0	CLIP BLOCCA PINZETTA RACCORDI D10 TIERRE	2.000	PZ
					EL1450A0	ELETTROVALV OLA H2O AUTOPULENT E BAF USA	3.000	PZ
					GN1526A0	O-RING D.INT6.9 SP1.8	7.000	PZ
					RC1018A0	FASCETTA ELASTICA D12 ZINCATA	1.000	PZ
					RC1019A0	FASCETTA ELASTICA D10 ZINCATA	12.000	PZ
					RC1130A0	FASCETTA 130X2,6	1.000	PZ
					RC1131A0	FASCETTA 200X2,6 BIANC	2.000	PZ
					RC1242A0	TERMINALE CHIUSO D10	2.000	PZ
					RC1356A0	RACCORDO DRITTO FIL. FEMM 8X1/4 BSP	1.000	PZ
					RC1414A1	FASCETTA STRINGITUBO A SCATTO D11.5-12.5	4.000	PZ
					TB2821A0	TB2820A-L=40 MM EPDM NER	4.000	PZ
					TB3004A0	TB2820A-L=57 0MM EPDM NERO	1.000	PZ
					TB3005B0	TB3132A-L=55 0MM EPDM BIANCO BLU	2.000	PZ
					TB3024C0	TB3132A-TUB O BLU 6X12 L=55MM	1.000	PZ
					TB3225B0	TB2820A-TUB O EPDM NERO 670MM	1.000	PZ
					TB3252A0	TB3132A-L=23 0MM EPDM BIANCO BLU	1.000	PZ
					TB3614A0	TB2820A-L=96 MM NERO EPD	1.000	PZ

COMPONENT			SPARE PART																																																																													
Code	Description	Image	Code	Description	Kit components																																																																											
0H2354A	LAMIERA IMPIANTO LAVAGGIO PLUS XEVC-XEVL		KVL1207A	US PLUS 1 ROTOR ARM WASHING SYSTEM KIT	<table border="1"> <thead> <tr> <th>Code</th> <th>Description</th> <th>Qty</th> <th>UOM</th> </tr> </thead> <tbody> <tr> <td>VI1220A1</td> <td>VITE AUTOFIL. 4.2X11 TCS+ MARUTEX</td> <td>1.000</td> <td>PZ</td> </tr> <tr> <td>VL1019A0</td> <td>POMPA DETERGENTE VIBRAZIONE</td> <td>1.000</td> <td>PZ</td> </tr> <tr> <td>VL1047A1</td> <td>PORTAGOMM A D6 CODOLO D8</td> <td>1.000</td> <td>PZ</td> </tr> <tr> <td>VL1102A1</td> <td>FILTRO IN LINEA DET. + VNR BARBED 6 MM</td> <td>1.000</td> <td>PZ</td> </tr> <tr> <td>VL1127A1</td> <td>RACCORDO A T BARBED 6</td> <td>1.000</td> <td>PZ</td> </tr> <tr> <td>VL1128A1</td> <td>VALVOLA VNR BARBED D6</td> <td>1.000</td> <td>PZ</td> </tr> <tr> <td>VL1166A0</td> <td>RACCORDO A L BAM-BB6</td> <td>3.000</td> <td>PZ</td> </tr> <tr> <td>VL1174C0</td> <td>UGELLO CALIBRATO D1.2 MM</td> <td>1.000</td> <td>PZ</td> </tr> <tr> <td>VL1185A0</td> <td>DISTRIBUTOR E LAVAGGIO PLUS 2 VIE UGELLO</td> <td>1.000</td> <td>PZ</td> </tr> <tr> <td>VL1190A0</td> <td>DISTRIBUTOR E INGRESSI LAVAGGIO PLUS</td> <td>1.000</td> <td>PZ</td> </tr> <tr> <td>VL1214A0</td> <td>VALVOLA VNR BB6-BAIONET TA</td> <td>1.000</td> <td>PZ</td> </tr> <tr> <td>VL1398A0</td> <td>PRESSOSTAT O.N.O. 1/4 M CI</td> <td>1.000</td> <td>PZ</td> </tr> <tr> <td>VM1605A0</td> <td>CLIP TWIST LOCK DIAM. 10,2-12,7 MM</td> <td>3.000</td> <td>PZ</td> </tr> <tr> <td>VM2172A0</td> <td>CLIP BLOCCAGGIO POMPA CON CIRCUITO</td> <td>4.000</td> <td>PZ</td> </tr> </tbody> </table>	Code	Description	Qty	UOM	VI1220A1	VITE AUTOFIL. 4.2X11 TCS+ MARUTEX	1.000	PZ	VL1019A0	POMPA DETERGENTE VIBRAZIONE	1.000	PZ	VL1047A1	PORTAGOMM A D6 CODOLO D8	1.000	PZ	VL1102A1	FILTRO IN LINEA DET. + VNR BARBED 6 MM	1.000	PZ	VL1127A1	RACCORDO A T BARBED 6	1.000	PZ	VL1128A1	VALVOLA VNR BARBED D6	1.000	PZ	VL1166A0	RACCORDO A L BAM-BB6	3.000	PZ	VL1174C0	UGELLO CALIBRATO D1.2 MM	1.000	PZ	VL1185A0	DISTRIBUTOR E LAVAGGIO PLUS 2 VIE UGELLO	1.000	PZ	VL1190A0	DISTRIBUTOR E INGRESSI LAVAGGIO PLUS	1.000	PZ	VL1214A0	VALVOLA VNR BB6-BAIONET TA	1.000	PZ	VL1398A0	PRESSOSTAT O.N.O. 1/4 M CI	1.000	PZ	VM1605A0	CLIP TWIST LOCK DIAM. 10,2-12,7 MM	3.000	PZ	VM2172A0	CLIP BLOCCAGGIO POMPA CON CIRCUITO	4.000	PZ	KVL1187A	3 ROTOR ARMS PLUS EU CLEANING SYSTEM KIT	<table border="1"> <thead> <tr> <th>Code</th> <th>Description</th> <th>Qty</th> <th>UOM</th> </tr> </thead> <tbody> <tr> <td>0H2354A2</td> <td>LAMIERA IMPIANTO LAVAGGIO PLUS XEVC-XEVL</td> <td>1.000</td> <td>PZ</td> </tr> <tr> <td>EL1346A0</td> <td>CLIP BLOCCA PINZETTA RACCORDI D10 TIERRE</td> <td>2.000</td> <td>PZ</td> </tr> </tbody> </table>	Code	Description	Qty	UOM	0H2354A2	LAMIERA IMPIANTO LAVAGGIO PLUS XEVC-XEVL	1.000	PZ	EL1346A0	CLIP BLOCCA PINZETTA RACCORDI D10 TIERRE	2.000	PZ
			Code	Description	Qty	UOM																																																																										
VI1220A1	VITE AUTOFIL. 4.2X11 TCS+ MARUTEX	1.000	PZ																																																																													
VL1019A0	POMPA DETERGENTE VIBRAZIONE	1.000	PZ																																																																													
VL1047A1	PORTAGOMM A D6 CODOLO D8	1.000	PZ																																																																													
VL1102A1	FILTRO IN LINEA DET. + VNR BARBED 6 MM	1.000	PZ																																																																													
VL1127A1	RACCORDO A T BARBED 6	1.000	PZ																																																																													
VL1128A1	VALVOLA VNR BARBED D6	1.000	PZ																																																																													
VL1166A0	RACCORDO A L BAM-BB6	3.000	PZ																																																																													
VL1174C0	UGELLO CALIBRATO D1.2 MM	1.000	PZ																																																																													
VL1185A0	DISTRIBUTOR E LAVAGGIO PLUS 2 VIE UGELLO	1.000	PZ																																																																													
VL1190A0	DISTRIBUTOR E INGRESSI LAVAGGIO PLUS	1.000	PZ																																																																													
VL1214A0	VALVOLA VNR BB6-BAIONET TA	1.000	PZ																																																																													
VL1398A0	PRESSOSTAT O.N.O. 1/4 M CI	1.000	PZ																																																																													
VM1605A0	CLIP TWIST LOCK DIAM. 10,2-12,7 MM	3.000	PZ																																																																													
VM2172A0	CLIP BLOCCAGGIO POMPA CON CIRCUITO	4.000	PZ																																																																													
Code	Description	Qty	UOM																																																																													
0H2354A2	LAMIERA IMPIANTO LAVAGGIO PLUS XEVC-XEVL	1.000	PZ																																																																													
EL1346A0	CLIP BLOCCA PINZETTA RACCORDI D10 TIERRE	2.000	PZ																																																																													





COMPONENT			SPARE PART																																																																														
Code	Description	Image	Code	Description	Kit components																																																																												
0H2354A	LAMIERA IMPIANTO LAVAGGIO PLUS XEVC-XEVL		KVL1187A	3 ROTOR ARMS PLUS EU CLEANING SYSTEM KIT	<table border="1"> <thead> <tr> <th>Code</th> <th>Description</th> <th>Qty</th> <th>UOM</th> </tr> </thead> <tbody> <tr> <td>EL1440A0</td> <td>ELETTROVALV OLA H2O AUTOPULENT E BAF EU</td> <td>4.000</td> <td>PZ</td> </tr> <tr> <td>GN1526A0</td> <td>O-RING D.INT6.9 SP1.8</td> <td>9.000</td> <td>PZ</td> </tr> <tr> <td>RC1018A0</td> <td>FASCETTA ELASTICA D12 ZINCATA</td> <td>11.000</td> <td>PZ</td> </tr> <tr> <td>RC1019A0</td> <td>FASCETTA ELASTICA D10 ZINCATA</td> <td>14.000</td> <td>PZ</td> </tr> <tr> <td>RC1130A0</td> <td>FASCETTA 130X2,6</td> <td>1.000</td> <td>PZ</td> </tr> <tr> <td>RC1131A0</td> <td>FASCETTA 200X2,6 BIANC</td> <td>3.000</td> <td>PZ</td> </tr> <tr> <td>RC1242A0</td> <td>TERMINALE CHIUSO D10</td> <td>2.000</td> <td>PZ</td> </tr> <tr> <td>RC1356A0</td> <td>RACCORDO DRITTO FIL. FEMM 8X1/4 BSP</td> <td>1.000</td> <td>PZ</td> </tr> <tr> <td>RC1414A1</td> <td>FASCETTA STRINGITUBO A SCATTO D11.5-12.5</td> <td>1.000</td> <td>PZ</td> </tr> <tr> <td>TB2652A0</td> <td>TB3132A-L750 MM BIANCO BLU EPDM</td> <td>1.000</td> <td>PZ</td> </tr> <tr> <td>TB2677A0</td> <td>TB2820A-TUB O TANICA DET-FDET L1300MM</td> <td>1.000</td> <td>PZ</td> </tr> <tr> <td>TB2821A0</td> <td>TB2820A-L=40 MM EPDM NER</td> <td>4.000</td> <td>PZ</td> </tr> <tr> <td>TB3004A0</td> <td>TB2820A-L=57 0MM EPDM NERO</td> <td>2.000</td> <td>PZ</td> </tr> <tr> <td>TB3024C0</td> <td>TB3132A-TUB O BLU 6X12 L=55MM</td> <td>3.000</td> <td>PZ</td> </tr> <tr> <td>TB3226A0</td> <td>TB2820A-L110 MM COLLEGAMEN TO TANICA-LA</td> <td>1.000</td> <td>PZ</td> </tr> <tr> <td>TB3440A0</td> <td>TB3132A-L=10 50MM EPDM BIANCO-BLU</td> <td>1.000</td> <td>PZ</td> </tr> <tr> <td>TB3614A0</td> <td>TB2820A-L=96 MM NERO EPD</td> <td>1.000</td> <td>PZ</td> </tr> <tr> <td>VI1220A1</td> <td>VITE AUTOFIL. 4.2X11 TCS+ MARUTEX</td> <td>1.000</td> <td>PZ</td> </tr> </tbody> </table>	Code	Description	Qty	UOM	EL1440A0	ELETTROVALV OLA H2O AUTOPULENT E BAF EU	4.000	PZ	GN1526A0	O-RING D.INT6.9 SP1.8	9.000	PZ	RC1018A0	FASCETTA ELASTICA D12 ZINCATA	11.000	PZ	RC1019A0	FASCETTA ELASTICA D10 ZINCATA	14.000	PZ	RC1130A0	FASCETTA 130X2,6	1.000	PZ	RC1131A0	FASCETTA 200X2,6 BIANC	3.000	PZ	RC1242A0	TERMINALE CHIUSO D10	2.000	PZ	RC1356A0	RACCORDO DRITTO FIL. FEMM 8X1/4 BSP	1.000	PZ	RC1414A1	FASCETTA STRINGITUBO A SCATTO D11.5-12.5	1.000	PZ	TB2652A0	TB3132A-L750 MM BIANCO BLU EPDM	1.000	PZ	TB2677A0	TB2820A-TUB O TANICA DET-FDET L1300MM	1.000	PZ	TB2821A0	TB2820A-L=40 MM EPDM NER	4.000	PZ	TB3004A0	TB2820A-L=57 0MM EPDM NERO	2.000	PZ	TB3024C0	TB3132A-TUB O BLU 6X12 L=55MM	3.000	PZ	TB3226A0	TB2820A-L110 MM COLLEGAMEN TO TANICA-LA	1.000	PZ	TB3440A0	TB3132A-L=10 50MM EPDM BIANCO-BLU	1.000	PZ	TB3614A0	TB2820A-L=96 MM NERO EPD	1.000	PZ	VI1220A1	VITE AUTOFIL. 4.2X11 TCS+ MARUTEX	1.000	PZ
					Code	Description	Qty	UOM																																																																									
					EL1440A0	ELETTROVALV OLA H2O AUTOPULENT E BAF EU	4.000	PZ																																																																									
					GN1526A0	O-RING D.INT6.9 SP1.8	9.000	PZ																																																																									
					RC1018A0	FASCETTA ELASTICA D12 ZINCATA	11.000	PZ																																																																									
					RC1019A0	FASCETTA ELASTICA D10 ZINCATA	14.000	PZ																																																																									
					RC1130A0	FASCETTA 130X2,6	1.000	PZ																																																																									
					RC1131A0	FASCETTA 200X2,6 BIANC	3.000	PZ																																																																									
					RC1242A0	TERMINALE CHIUSO D10	2.000	PZ																																																																									
					RC1356A0	RACCORDO DRITTO FIL. FEMM 8X1/4 BSP	1.000	PZ																																																																									
					RC1414A1	FASCETTA STRINGITUBO A SCATTO D11.5-12.5	1.000	PZ																																																																									
					TB2652A0	TB3132A-L750 MM BIANCO BLU EPDM	1.000	PZ																																																																									
					TB2677A0	TB2820A-TUB O TANICA DET-FDET L1300MM	1.000	PZ																																																																									
					TB2821A0	TB2820A-L=40 MM EPDM NER	4.000	PZ																																																																									
					TB3004A0	TB2820A-L=57 0MM EPDM NERO	2.000	PZ																																																																									
					TB3024C0	TB3132A-TUB O BLU 6X12 L=55MM	3.000	PZ																																																																									
					TB3226A0	TB2820A-L110 MM COLLEGAMEN TO TANICA-LA	1.000	PZ																																																																									
					TB3440A0	TB3132A-L=10 50MM EPDM BIANCO-BLU	1.000	PZ																																																																									
					TB3614A0	TB2820A-L=96 MM NERO EPD	1.000	PZ																																																																									
					VI1220A1	VITE AUTOFIL. 4.2X11 TCS+ MARUTEX	1.000	PZ																																																																									

COMPONENT			SPARE PART																																																																													
Code	Description	Image	Code	Description	Kit components																																																																											
0H2354A	LAMIERA IMPIANTO LAVAGGIO PLUS XEVC-XEVL		KVL1187A	3 ROTOR ARMS PLUS EU CLEANING SYSTEM KIT	<table border="1"> <thead> <tr> <th>Code</th> <th>Description</th> <th>Qty</th> <th>UOM</th> </tr> </thead> <tbody> <tr> <td>VL1019A0</td> <td>POMPA DETERGENTE VIBRAZIONE</td> <td>1.000</td> <td>PZ</td> </tr> <tr> <td>VL1047A1</td> <td>PORTAGOMM A D6 CODOLO D8</td> <td>1.000</td> <td>PZ</td> </tr> <tr> <td>VL1102A1</td> <td>FILTRO IN LINEA DET. + VNR BARBED 6 MM</td> <td>1.000</td> <td>PZ</td> </tr> <tr> <td>VL1127A1</td> <td>RACCORDO A T BARBED 6</td> <td>2.000</td> <td>PZ</td> </tr> <tr> <td>VL1128A1</td> <td>VALVOLA VNR BARBED D6</td> <td>2.000</td> <td>PZ</td> </tr> <tr> <td>VL1166A0</td> <td>RACCORDO A L BAM-BB6</td> <td>4.000</td> <td>PZ</td> </tr> <tr> <td>VL1167A2</td> <td>FLOW RESTRICTOR 3 GIRANTI GN21 B-B</td> <td>1.000</td> <td>PZ</td> </tr> <tr> <td>VL1174C0</td> <td>UGELLO CALIBRATO D1.2 MM</td> <td>1.000</td> <td>PZ</td> </tr> <tr> <td>VL1186A0</td> <td>DISTRIBUTOR E LAVAGGIO PLUS 3 VIE UGELLO</td> <td>1.000</td> <td>PZ</td> </tr> <tr> <td>VL1190A0</td> <td>DISTRIBUTOR E INGRESSI LAVAGGIO PLUS</td> <td>1.000</td> <td>PZ</td> </tr> <tr> <td>VL1214A0</td> <td>VALVOLA VNR BB6-BAIONET TA</td> <td>1.000</td> <td>PZ</td> </tr> <tr> <td>VL1398A0</td> <td>PRESSOSTAT O N.O. 1/4 M CI</td> <td>1.000</td> <td>PZ</td> </tr> <tr> <td>VM1605A0</td> <td>CLIP TWIST LOCK DIAM. 10.2-12.7 MM</td> <td>3.000</td> <td>PZ</td> </tr> <tr> <td>VM2172A0</td> <td>CLIP BLOCCAGGIO POMPA CON CIRCUITO</td> <td>5.000</td> <td>PZ</td> </tr> </tbody> </table>	Code	Description	Qty	UOM	VL1019A0	POMPA DETERGENTE VIBRAZIONE	1.000	PZ	VL1047A1	PORTAGOMM A D6 CODOLO D8	1.000	PZ	VL1102A1	FILTRO IN LINEA DET. + VNR BARBED 6 MM	1.000	PZ	VL1127A1	RACCORDO A T BARBED 6	2.000	PZ	VL1128A1	VALVOLA VNR BARBED D6	2.000	PZ	VL1166A0	RACCORDO A L BAM-BB6	4.000	PZ	VL1167A2	FLOW RESTRICTOR 3 GIRANTI GN21 B-B	1.000	PZ	VL1174C0	UGELLO CALIBRATO D1.2 MM	1.000	PZ	VL1186A0	DISTRIBUTOR E LAVAGGIO PLUS 3 VIE UGELLO	1.000	PZ	VL1190A0	DISTRIBUTOR E INGRESSI LAVAGGIO PLUS	1.000	PZ	VL1214A0	VALVOLA VNR BB6-BAIONET TA	1.000	PZ	VL1398A0	PRESSOSTAT O N.O. 1/4 M CI	1.000	PZ	VM1605A0	CLIP TWIST LOCK DIAM. 10.2-12.7 MM	3.000	PZ	VM2172A0	CLIP BLOCCAGGIO POMPA CON CIRCUITO	5.000	PZ	KVL1184A	2 ROTOR ARMS PLUS EU CLEANING SYSTEM KIT	<table border="1"> <thead> <tr> <th>Code</th> <th>Description</th> <th>Qty</th> <th>UOM</th> </tr> </thead> <tbody> <tr> <td>0H2354A2</td> <td>LAMIERA IMPIANTO LAVAGGIO PLUS XEVC-XEVL</td> <td>1.000</td> <td>PZ</td> </tr> <tr> <td>EL1346A0</td> <td>CLIP BLOCCA PINZETTA RACCORDI D10 TIERRE</td> <td>2.000</td> <td>PZ</td> </tr> </tbody> </table>	Code	Description	Qty	UOM	0H2354A2	LAMIERA IMPIANTO LAVAGGIO PLUS XEVC-XEVL	1.000	PZ	EL1346A0	CLIP BLOCCA PINZETTA RACCORDI D10 TIERRE	2.000	PZ
			Code	Description	Qty	UOM																																																																										
VL1019A0	POMPA DETERGENTE VIBRAZIONE	1.000	PZ																																																																													
VL1047A1	PORTAGOMM A D6 CODOLO D8	1.000	PZ																																																																													
VL1102A1	FILTRO IN LINEA DET. + VNR BARBED 6 MM	1.000	PZ																																																																													
VL1127A1	RACCORDO A T BARBED 6	2.000	PZ																																																																													
VL1128A1	VALVOLA VNR BARBED D6	2.000	PZ																																																																													
VL1166A0	RACCORDO A L BAM-BB6	4.000	PZ																																																																													
VL1167A2	FLOW RESTRICTOR 3 GIRANTI GN21 B-B	1.000	PZ																																																																													
VL1174C0	UGELLO CALIBRATO D1.2 MM	1.000	PZ																																																																													
VL1186A0	DISTRIBUTOR E LAVAGGIO PLUS 3 VIE UGELLO	1.000	PZ																																																																													
VL1190A0	DISTRIBUTOR E INGRESSI LAVAGGIO PLUS	1.000	PZ																																																																													
VL1214A0	VALVOLA VNR BB6-BAIONET TA	1.000	PZ																																																																													
VL1398A0	PRESSOSTAT O N.O. 1/4 M CI	1.000	PZ																																																																													
VM1605A0	CLIP TWIST LOCK DIAM. 10.2-12.7 MM	3.000	PZ																																																																													
VM2172A0	CLIP BLOCCAGGIO POMPA CON CIRCUITO	5.000	PZ																																																																													
Code	Description	Qty	UOM																																																																													
0H2354A2	LAMIERA IMPIANTO LAVAGGIO PLUS XEVC-XEVL	1.000	PZ																																																																													
EL1346A0	CLIP BLOCCA PINZETTA RACCORDI D10 TIERRE	2.000	PZ																																																																													

COMPONENT			SPARE PART					
Code	Description	Image	Code	Description	Kit components			
0H2354A	LAMIERA IMPIANTO LAVAGGIO PLUS XEVC-XEVL		KVL1184A	2 ROTOR ARMS PLUS EU CLEANING SYSTEM KIT	Code	Description	Qty	UOM
					EL1440A0	ELETTROVALV OLA H2O AUTOPULENT E BAF EU	4.000	PZ
					GN1526A0	O-RING D.INT6,9 SP1.8	9.000	PZ
					RC1018A0	FASCETTA ELASTICA D12 ZINCATA	2.000	PZ
					RC1019A0	FASCETTA ELASTICA D10 ZINCATA	13.000	PZ
					RC1130A0	FASCETTA 130X2,6	1.000	PZ
					RC1131A0	FASCETTA 200X2,6 BIANC	3.000	PZ
					RC1242A0	TERMINALE CHIUSO D10	2.000	PZ
					RC1356A0	RACCORDO DRITTO FIL. FEMM 8X1/4 BSP	1.000	PZ
					RC1414A1	FASCETTA STRINGITUBO A SCATTO D11.5-12.5	1.000	PZ
					TB2821A0	TB2820A-L=40 MM EPDM NER	4.000	PZ
					TB2994A0	TB2820A-TUB O EPDM NERO 1000MM	1.000	PZ
					TB3004A0	TB2820A-L=57 0MM EPDM NERO	2.000	PZ
					TB3005B0	TB3132A-L=55 0MM EPDM BIANCO BLU	1.000	PZ
					TB3440A0	TB3132A-L=10 50MM EPDM BIANCO-BLU	1.000	PZ
					TB3614A0	TB2820A-L=96 MM NERO EPD	1.000	PZ
					VI1220A1	VITE AUTOFIL. 4.2X11 TCS+ MARUTEX	1.000	PZ
					VL1019A0	POMPA DETERGENTE VIBRAZIONE	1.000	PZ
					VL1047A1	PORTAGOMM A D6 CODOLO D8	1.000	PZ
					VL1102A1	FILTRO IN LINEA DET. + VNR BARBED 6 MM	1.000	PZ





COMPONENT			SPARE PART																																										
Code	Description	Image	Code	Description	Kit components																																								
0H2354A	LAMIERA IMPIANTO LAVAGGIO PLUS XEVC-XEVL		KVL1184A	2 ROTOR ARMS PLUS EU CLEANING SYSTEM KIT	<table border="1"> <thead> <tr> <th>Code</th> <th>Description</th> <th>Qty</th> <th>UOM</th> </tr> </thead> <tbody> <tr> <td>VL1128A1</td> <td>VALVOLA VNR BARBED D6</td> <td>1.000</td> <td>PZ</td> </tr> <tr> <td>VL1166A0</td> <td>RACCORDO A L BAM-BB6</td> <td>4.000</td> <td>PZ</td> </tr> <tr> <td>VL1174C0</td> <td>UGELLO CALIBRATO D1.2 MM</td> <td>1.000</td> <td>PZ</td> </tr> <tr> <td>VL1186A0</td> <td>DISTRIBUTOR E LAVAGGIO PLUS 3 VIE UGELLO</td> <td>1.000</td> <td>PZ</td> </tr> <tr> <td>VL1190A0</td> <td>DISTRIBUTOR E INGRESSI LAVAGGIO PLUS</td> <td>1.000</td> <td>PZ</td> </tr> <tr> <td>VL1214A0</td> <td>VALVOLA VNR BB6-BAIONET TA</td> <td>1.000</td> <td>PZ</td> </tr> <tr> <td>VL1398A0</td> <td>PRESSOSTAT O N.O. 1/4 M CI</td> <td>1.000</td> <td>PZ</td> </tr> <tr> <td>VM1605A0</td> <td>CLIP TWIST LOCK DIAM. 10,2-12,7 MM</td> <td>3.000</td> <td>PZ</td> </tr> <tr> <td>VM2172A0</td> <td>CLIP BLOCCAGGIO POMPA CON CIRCUITO</td> <td>5.000</td> <td>PZ</td> </tr> </tbody> </table>	Code	Description	Qty	UOM	VL1128A1	VALVOLA VNR BARBED D6	1.000	PZ	VL1166A0	RACCORDO A L BAM-BB6	4.000	PZ	VL1174C0	UGELLO CALIBRATO D1.2 MM	1.000	PZ	VL1186A0	DISTRIBUTOR E LAVAGGIO PLUS 3 VIE UGELLO	1.000	PZ	VL1190A0	DISTRIBUTOR E INGRESSI LAVAGGIO PLUS	1.000	PZ	VL1214A0	VALVOLA VNR BB6-BAIONET TA	1.000	PZ	VL1398A0	PRESSOSTAT O N.O. 1/4 M CI	1.000	PZ	VM1605A0	CLIP TWIST LOCK DIAM. 10,2-12,7 MM	3.000	PZ	VM2172A0	CLIP BLOCCAGGIO POMPA CON CIRCUITO	5.000	PZ
			Code	Description	Qty	UOM																																							
VL1128A1	VALVOLA VNR BARBED D6	1.000	PZ																																										
VL1166A0	RACCORDO A L BAM-BB6	4.000	PZ																																										
VL1174C0	UGELLO CALIBRATO D1.2 MM	1.000	PZ																																										
VL1186A0	DISTRIBUTOR E LAVAGGIO PLUS 3 VIE UGELLO	1.000	PZ																																										
VL1190A0	DISTRIBUTOR E INGRESSI LAVAGGIO PLUS	1.000	PZ																																										
VL1214A0	VALVOLA VNR BB6-BAIONET TA	1.000	PZ																																										
VL1398A0	PRESSOSTAT O N.O. 1/4 M CI	1.000	PZ																																										
VM1605A0	CLIP TWIST LOCK DIAM. 10,2-12,7 MM	3.000	PZ																																										
VM2172A0	CLIP BLOCCAGGIO POMPA CON CIRCUITO	5.000	PZ																																										
KVL1183A	1 ROTOR ARM PLUS CLEANING SYSTEM KIT	<table border="1"> <thead> <tr> <th>Code</th> <th>Description</th> <th>Qty</th> <th>UOM</th> </tr> </thead> <tbody> <tr> <td>0H2354A2</td> <td>LAMIERA IMPIANTO LAVAGGIO PLUS XEVC-XEVL</td> <td>1.000</td> <td>PZ</td> </tr> <tr> <td>EL1346A0</td> <td>CLIP BLOCCA PINZETTA RACCORDI D10 TIERRE</td> <td>2.000</td> <td>PZ</td> </tr> <tr> <td>EL1440A0</td> <td>ELETTROVALV OLA H2O AUTOPULENT E BAF EU</td> <td>3.000</td> <td>PZ</td> </tr> <tr> <td>GN1526A0</td> <td>O-RING D.INT6.9 SP1.8</td> <td>7.000</td> <td>PZ</td> </tr> <tr> <td>RC1018A0</td> <td>FASCETTA ELASTICA D12 ZINCATA</td> <td>1.000</td> <td>PZ</td> </tr> <tr> <td>RC1019A0</td> <td>FASCETTA ELASTICA D10 ZINCATA</td> <td>12.000</td> <td>PZ</td> </tr> <tr> <td>RC1130A0</td> <td>FASCETTA 130X2,6</td> <td>1.000</td> <td>PZ</td> </tr> <tr> <td>RC1131A0</td> <td>FASCETTA 200X2.6 BIANC</td> <td>2.000</td> <td>PZ</td> </tr> </tbody> </table>	Code	Description	Qty	UOM	0H2354A2	LAMIERA IMPIANTO LAVAGGIO PLUS XEVC-XEVL	1.000	PZ	EL1346A0	CLIP BLOCCA PINZETTA RACCORDI D10 TIERRE	2.000	PZ	EL1440A0	ELETTROVALV OLA H2O AUTOPULENT E BAF EU	3.000	PZ	GN1526A0	O-RING D.INT6.9 SP1.8	7.000	PZ	RC1018A0	FASCETTA ELASTICA D12 ZINCATA	1.000	PZ	RC1019A0	FASCETTA ELASTICA D10 ZINCATA	12.000	PZ	RC1130A0	FASCETTA 130X2,6	1.000	PZ	RC1131A0	FASCETTA 200X2.6 BIANC	2.000	PZ							
Code	Description	Qty	UOM																																										
0H2354A2	LAMIERA IMPIANTO LAVAGGIO PLUS XEVC-XEVL	1.000	PZ																																										
EL1346A0	CLIP BLOCCA PINZETTA RACCORDI D10 TIERRE	2.000	PZ																																										
EL1440A0	ELETTROVALV OLA H2O AUTOPULENT E BAF EU	3.000	PZ																																										
GN1526A0	O-RING D.INT6.9 SP1.8	7.000	PZ																																										
RC1018A0	FASCETTA ELASTICA D12 ZINCATA	1.000	PZ																																										
RC1019A0	FASCETTA ELASTICA D10 ZINCATA	12.000	PZ																																										
RC1130A0	FASCETTA 130X2,6	1.000	PZ																																										
RC1131A0	FASCETTA 200X2.6 BIANC	2.000	PZ																																										

COMPONENT			SPARE PART					
Code	Description	Image	Code	Description	Kit components			
0H2354A	LAMIERA IMPIANTO LAVAGGIO PLUS XEVC-XEVL		KVL1183A	1 ROTOR ARM PLUS CLEANING SYSTEM KIT	Code	Description	Qty	UOM
					RC1242A0	TERMINALE CHIUSO D10	2.000	PZ
					RC1356A0	RACCORDO DRITTO FIL. FEMM 8X1/4 BSP	1.000	PZ
					RC1414A1	FASCETTA STRINGITUBO A SCATTO D11.5-12.5	4.000	PZ
					TB2821A0	TB2820A-L=40 MM EPDM NER	4.000	PZ
					TB3004A0	TB2820A-L=57 0MM EPDM NERO	1.000	PZ
					TB3252A0	TB3132A-L=23 0MM EPDM BIANCO BLU	1.000	PZ
					TB3614A0	TB2820A-L=96 MM NERO EPD	1.000	PZ
					TB5360A0	TB3132A-TUB O EPDM TELATO BIANCO-BLU 550M	1.000	PZ
					TB5362A0	TB3132A-TUB O EPDM TELATO BIANCO-BLU 230M	1.000	PZ
					VI1220A1	VITE AUTOFIL. 4.2X11 TCS+ MARUTEX	1.000	PZ
					VL1019A0	POMPA DETERGENTE VIBRAZIONE	1.000	PZ
					VL1047A1	PORTAGOMM A D6 CODOLO D8	1.000	PZ
					VL1102A1	FILTRO IN LINEA DET. + VNR BARBED 6 MM	1.000	PZ
					VL1128A1	VALVOLA VNR BARBED D6	1.000	PZ
					VL1166A0	RACCORDO A L BAM-BB6	3.000	PZ
					VL1174C0	UGELLO CALIBRATO D1.2 MM	1.000	PZ
					VL1185A0	DISTRIBUTOR E LAVAGGIO PLUS 2 VIE UGELLO	1.000	PZ

COMPONENT			SPARE PART																										
Code	Description	Image	Code	Description	Kit components																								
0H2354A	LAMIERA IMPIANTO LAVAGGIO PLUS XEVC-XEVL		KVL1183A	1 ROTOR ARM PLUS CLEANING SYSTEM KIT	<table border="1"> <thead> <tr> <th>Code</th> <th>Description</th> <th>Qty</th> <th>UOM</th> </tr> </thead> <tbody> <tr> <td>VL1190A0</td> <td>DISTRIBUTOR E INGRESSI LAVAGGIO PLUS</td> <td>1.000</td> <td>PZ</td> </tr> <tr> <td>VL1214A0</td> <td>VALVOLA VNR BB6-BAIONET TA</td> <td>1.000</td> <td>PZ</td> </tr> <tr> <td>VL1398A0</td> <td>PRESSOSTAT O.N.O. 1/4 M CI</td> <td>1.000</td> <td>PZ</td> </tr> <tr> <td>VM1605A0</td> <td>CLIP TWIST LOCK DIAM. 10,2-12,7 MM</td> <td>3.000</td> <td>PZ</td> </tr> <tr> <td>VM2172A0</td> <td>CLIP BLOCCAGGIO POMPA CON CIRCUITO</td> <td>4.000</td> <td>PZ</td> </tr> </tbody> </table>	Code	Description	Qty	UOM	VL1190A0	DISTRIBUTOR E INGRESSI LAVAGGIO PLUS	1.000	PZ	VL1214A0	VALVOLA VNR BB6-BAIONET TA	1.000	PZ	VL1398A0	PRESSOSTAT O.N.O. 1/4 M CI	1.000	PZ	VM1605A0	CLIP TWIST LOCK DIAM. 10,2-12,7 MM	3.000	PZ	VM2172A0	CLIP BLOCCAGGIO POMPA CON CIRCUITO	4.000	PZ
					Code	Description	Qty	UOM																					
					VL1190A0	DISTRIBUTOR E INGRESSI LAVAGGIO PLUS	1.000	PZ																					
					VL1214A0	VALVOLA VNR BB6-BAIONET TA	1.000	PZ																					
					VL1398A0	PRESSOSTAT O.N.O. 1/4 M CI	1.000	PZ																					
VM1605A0	CLIP TWIST LOCK DIAM. 10,2-12,7 MM	3.000	PZ																										
VM2172A0	CLIP BLOCCAGGIO POMPA CON CIRCUITO	4.000	PZ																										
EL1220A	RACCORDO DRITTO Ø8F-Ø8F		KEL1220A	D8F-D8F JG STRAIGHT FITTING 10 PCS KIT	<table border="1"> <thead> <tr> <th>Code</th> <th>Description</th> <th>Qty</th> <th>UOM</th> </tr> </thead> <tbody> <tr> <td>EL1220A0</td> <td>RACCORDO DRITTO Ø8F-Ø8F</td> <td>10.000</td> <td>PZ</td> </tr> </tbody> </table>	Code	Description	Qty	UOM	EL1220A0	RACCORDO DRITTO Ø8F-Ø8F	10.000	PZ																
					Code	Description	Qty	UOM																					
					EL1220A0	RACCORDO DRITTO Ø8F-Ø8F	10.000	PZ																					
					GN1526A	O-RING D.INT6.9 SP1.8		KGN1526A	O-RING INT D6.9 THICK1.8 10PCS KIT	<table border="1"> <thead> <tr> <th>Code</th> <th>Description</th> <th>Qty</th> <th>UOM</th> </tr> </thead> <tbody> <tr> <td>GN1526A0</td> <td>O-RING D.INT6.9 SP1.8</td> <td>10.000</td> <td>PZ</td> </tr> </tbody> </table>	Code	Description	Qty	UOM	GN1526A0	O-RING D.INT6.9 SP1.8	10.000	PZ											
Code	Description	Qty	UOM																										
GN1526A0	O-RING D.INT6.9 SP1.8	10.000	PZ																										
RC1019A	FASCETTA ELASTICA D10 ZINCATA		KRC1019A	Ø10 ZINC PLATED ELASTIC CLAMP 15 PCS KIT	<table border="1"> <thead> <tr> <th>Code</th> <th>Description</th> <th>Qty</th> <th>UOM</th> </tr> </thead> <tbody> <tr> <td>RC1019A0</td> <td>FASCETTA ELASTICA D10 ZINCATA</td> <td>15.000</td> <td>PZ</td> </tr> </tbody> </table>	Code	Description	Qty	UOM	RC1019A0	FASCETTA ELASTICA D10 ZINCATA	15.000	PZ																
					Code	Description	Qty	UOM																					
RC1019A0	FASCETTA ELASTICA D10 ZINCATA	15.000	PZ																										

COMPONENT			SPARE PART																																																										
Code	Description	Image	Code	Description	Kit components																																																								
RC1242A	TERMINALE CHIUSO D10		KRC1242A	Ø10 JG CAP 20PCS KIT	<table border="1"> <thead> <tr> <th>Code</th> <th>Description</th> <th>Qty</th> <th>UOM</th> </tr> </thead> <tbody> <tr> <td>EL1346A0</td> <td>CLIP BLOCCA PINZETTA RACCORDI D10 TIERRE</td> <td>20.000</td> <td>PZ</td> </tr> <tr> <td>RC1242A0</td> <td>TERMINALE CHIUSO D10</td> <td>20.000</td> <td>PZ</td> </tr> </tbody> </table>	Code	Description	Qty	UOM	EL1346A0	CLIP BLOCCA PINZETTA RACCORDI D10 TIERRE	20.000	PZ	RC1242A0	TERMINALE CHIUSO D10	20.000	PZ																																												
Code	Description	Qty	UOM																																																										
EL1346A0	CLIP BLOCCA PINZETTA RACCORDI D10 TIERRE	20.000	PZ																																																										
RC1242A0	TERMINALE CHIUSO D10	20.000	PZ																																																										
VL1019A	POMPA DETERGENTE VIBRAZIONE		KVL2618A	2 ROTOR ARMS ONE CLEANING SYSTEM KIT	<table border="1"> <thead> <tr> <th>Code</th> <th>Description</th> <th>Qty</th> <th>UOM</th> </tr> </thead> <tbody> <tr> <td>0H2202A1</td> <td>STAFFA LAVAGGIO ONE CON ELV STEAM</td> <td>2.000</td> <td>PZ</td> </tr> <tr> <td>CE1030A0</td> <td>FASTON FEMMINA 6.3X0.8 0.5-1mmq</td> <td>4.000</td> <td>PZ</td> </tr> <tr> <td>CE1395A0</td> <td>FASTON MASCCHIO 6,3 X 0,8 RAME STAGNATO</td> <td>2.000</td> <td>PZ</td> </tr> <tr> <td>CE1545A0</td> <td>CAVO UNIP AWG18 ST.3135 BLU</td> <td>2.000</td> <td>M</td> </tr> <tr> <td>CE1570A0</td> <td>CAVO UNIP AWG18 ST.3135 BIANC</td> <td>2.000</td> <td>M</td> </tr> <tr> <td>CE1660A0</td> <td>COPRI FASTON FEMMINA 6.3X0.8</td> <td>4.000</td> <td>PZ</td> </tr> <tr> <td>CE1661A0</td> <td>COPRI FASTON MASCCHIO 6.3X0.8</td> <td>2.000</td> <td>PZ</td> </tr> <tr> <td>EL1020A1</td> <td>RACCORDO INTERMEDIO "T" TUBO D8 J</td> <td>1.000</td> <td>PZ</td> </tr> <tr> <td>EL1346A0</td> <td>CLIP BLOCCA PINZETTA RACCORDI D10 TIERRE</td> <td>4.000</td> <td>PZ</td> </tr> <tr> <td>EL1440A0</td> <td>ELETTROVALV OLA H2O AUTOPULENT E BAF EU</td> <td>2.000</td> <td>PZ</td> </tr> <tr> <td>GN1526A0</td> <td>O-RING D.INT6.9 SP1.8</td> <td>6.000</td> <td>PZ</td> </tr> <tr> <td>RC1018A0</td> <td>FASCETTA ELASTICA D12 ZINCATA</td> <td>2.000</td> <td>PZ</td> </tr> <tr> <td>RC1019A0</td> <td>FASCETTA ELASTICA D10 ZINCATA</td> <td>3.000</td> <td>PZ</td> </tr> </tbody> </table>	Code	Description	Qty	UOM	0H2202A1	STAFFA LAVAGGIO ONE CON ELV STEAM	2.000	PZ	CE1030A0	FASTON FEMMINA 6.3X0.8 0.5-1mmq	4.000	PZ	CE1395A0	FASTON MASCCHIO 6,3 X 0,8 RAME STAGNATO	2.000	PZ	CE1545A0	CAVO UNIP AWG18 ST.3135 BLU	2.000	M	CE1570A0	CAVO UNIP AWG18 ST.3135 BIANC	2.000	M	CE1660A0	COPRI FASTON FEMMINA 6.3X0.8	4.000	PZ	CE1661A0	COPRI FASTON MASCCHIO 6.3X0.8	2.000	PZ	EL1020A1	RACCORDO INTERMEDIO "T" TUBO D8 J	1.000	PZ	EL1346A0	CLIP BLOCCA PINZETTA RACCORDI D10 TIERRE	4.000	PZ	EL1440A0	ELETTROVALV OLA H2O AUTOPULENT E BAF EU	2.000	PZ	GN1526A0	O-RING D.INT6.9 SP1.8	6.000	PZ	RC1018A0	FASCETTA ELASTICA D12 ZINCATA	2.000	PZ	RC1019A0	FASCETTA ELASTICA D10 ZINCATA	3.000	PZ
Code	Description	Qty	UOM																																																										
0H2202A1	STAFFA LAVAGGIO ONE CON ELV STEAM	2.000	PZ																																																										
CE1030A0	FASTON FEMMINA 6.3X0.8 0.5-1mmq	4.000	PZ																																																										
CE1395A0	FASTON MASCCHIO 6,3 X 0,8 RAME STAGNATO	2.000	PZ																																																										
CE1545A0	CAVO UNIP AWG18 ST.3135 BLU	2.000	M																																																										
CE1570A0	CAVO UNIP AWG18 ST.3135 BIANC	2.000	M																																																										
CE1660A0	COPRI FASTON FEMMINA 6.3X0.8	4.000	PZ																																																										
CE1661A0	COPRI FASTON MASCCHIO 6.3X0.8	2.000	PZ																																																										
EL1020A1	RACCORDO INTERMEDIO "T" TUBO D8 J	1.000	PZ																																																										
EL1346A0	CLIP BLOCCA PINZETTA RACCORDI D10 TIERRE	4.000	PZ																																																										
EL1440A0	ELETTROVALV OLA H2O AUTOPULENT E BAF EU	2.000	PZ																																																										
GN1526A0	O-RING D.INT6.9 SP1.8	6.000	PZ																																																										
RC1018A0	FASCETTA ELASTICA D12 ZINCATA	2.000	PZ																																																										
RC1019A0	FASCETTA ELASTICA D10 ZINCATA	3.000	PZ																																																										

COMPONENT			SPARE PART																																																																																																																			
Code	Description	Image	Code	Description	Kit components																																																																																																																	
VL1019A	POMPA DETERGENTE VIBRAZIONE		KVL2618A	2 ROTOR ARMS ONE CLEANING SYSTEM KIT	<table border="1"> <thead> <tr> <th>Code</th> <th>Description</th> <th>Qty</th> <th>UOM</th> </tr> </thead> <tbody> <tr> <td>RC1130A0</td> <td>FASCETTA 130X2,6</td> <td>4.000</td> <td>PZ</td> </tr> <tr> <td>RC1242A0</td> <td>TERMINALE CHIUSO D10</td> <td>4.000</td> <td>PZ</td> </tr> <tr> <td>RC1414A1</td> <td>FASCETTA STRINGITUBO A SCATTO D11.5-12.5</td> <td>5.000</td> <td>PZ</td> </tr> <tr> <td>TB2821A0</td> <td>TB2820A-L=40 MM EPDM NER</td> <td>12.000</td> <td>PZ</td> </tr> <tr> <td>TB3004A0</td> <td>TB2820A-L=57 0MM EPDM NERO</td> <td>2.000</td> <td>PZ</td> </tr> <tr> <td>TB3009B0</td> <td>TB3132A-L=67 0MM EPDM BIANCO BLU</td> <td>2.000</td> <td>PZ</td> </tr> <tr> <td>TB3225B0</td> <td>TB2820A-TUB O EPDM NERO 670MM</td> <td>2.000</td> <td>PZ</td> </tr> <tr> <td>VH1220A1</td> <td>VITE AUTOFIL. 4.2X11 TCS+ MARUTEX</td> <td>2.000</td> <td>PZ</td> </tr> <tr> <td>VL1019A0</td> <td>POMPA DETERGENTE VIBRAZIONE</td> <td></td> <td>2.000</td> <td>PZ</td> <td></td> <td></td> </tr> <tr> <td>VL1047A1</td> <td>PORTAGOMM A D6 CODOLO D8</td> <td></td> <td>2.000</td> <td>PZ</td> <td></td> <td></td> </tr> <tr> <td>VL1054B0</td> <td>DISTRIBUTOR E INGRESSI LAVAGGIO ON</td> <td></td> <td>2.000</td> <td>PZ</td> <td></td> <td></td> </tr> <tr> <td>VL1102A1</td> <td>FILTRO IN LINEA DET. + VNR BARBED 6 MM</td> <td></td> <td>2.000</td> <td>PZ</td> <td></td> <td></td> </tr> <tr> <td>VL1127A1</td> <td>RACCORDO A T BARBED 6</td> <td></td> <td>1.000</td> <td>PZ</td> <td></td> <td></td> </tr> <tr> <td>VL1128A1</td> <td>VALVOLA VNR BARBED D6</td> <td></td> <td>4.000</td> <td>PZ</td> <td></td> <td></td> </tr> <tr> <td>VL1166A0</td> <td>RACCORDO A L BAM-BB6</td> <td></td> <td>2.000</td> <td>PZ</td> <td></td> <td></td> </tr> <tr> <td>VL1174C0</td> <td>UGELLO CALIBRATO D1.2 MM</td> <td></td> <td>2.000</td> <td>PZ</td> <td></td> <td></td> </tr> <tr> <td>VL1191A0</td> <td>DISTRIBUTOR E USCITA LAVAGGIO ON</td> <td></td> <td>2.000</td> <td>PZ</td> <td></td> <td></td> </tr> <tr> <td>VL1214A0</td> <td>VALVOLA VNR BB6-BAIONET TA</td> <td></td> <td>2.000</td> <td>PZ</td> <td></td> <td></td> </tr> <tr> <td>VM2172A0</td> <td>CLIP BLOCCAGGIO POMPA CON CIRCUITO</td> <td></td> <td>4.000</td> <td>PZ</td> <td></td> <td></td> </tr> </tbody> </table>	Code	Description	Qty	UOM	RC1130A0	FASCETTA 130X2,6	4.000	PZ	RC1242A0	TERMINALE CHIUSO D10	4.000	PZ	RC1414A1	FASCETTA STRINGITUBO A SCATTO D11.5-12.5	5.000	PZ	TB2821A0	TB2820A-L=40 MM EPDM NER	12.000	PZ	TB3004A0	TB2820A-L=57 0MM EPDM NERO	2.000	PZ	TB3009B0	TB3132A-L=67 0MM EPDM BIANCO BLU	2.000	PZ	TB3225B0	TB2820A-TUB O EPDM NERO 670MM	2.000	PZ	VH1220A1	VITE AUTOFIL. 4.2X11 TCS+ MARUTEX	2.000	PZ	VL1019A0	POMPA DETERGENTE VIBRAZIONE		2.000	PZ			VL1047A1	PORTAGOMM A D6 CODOLO D8		2.000	PZ			VL1054B0	DISTRIBUTOR E INGRESSI LAVAGGIO ON		2.000	PZ			VL1102A1	FILTRO IN LINEA DET. + VNR BARBED 6 MM		2.000	PZ			VL1127A1	RACCORDO A T BARBED 6		1.000	PZ			VL1128A1	VALVOLA VNR BARBED D6		4.000	PZ			VL1166A0	RACCORDO A L BAM-BB6		2.000	PZ			VL1174C0	UGELLO CALIBRATO D1.2 MM		2.000	PZ			VL1191A0	DISTRIBUTOR E USCITA LAVAGGIO ON		2.000	PZ			VL1214A0	VALVOLA VNR BB6-BAIONET TA		2.000	PZ			VM2172A0	CLIP BLOCCAGGIO POMPA CON CIRCUITO		4.000	PZ		
Code	Description	Qty	UOM																																																																																																																			
RC1130A0	FASCETTA 130X2,6	4.000	PZ																																																																																																																			
RC1242A0	TERMINALE CHIUSO D10	4.000	PZ																																																																																																																			
RC1414A1	FASCETTA STRINGITUBO A SCATTO D11.5-12.5	5.000	PZ																																																																																																																			
TB2821A0	TB2820A-L=40 MM EPDM NER	12.000	PZ																																																																																																																			
TB3004A0	TB2820A-L=57 0MM EPDM NERO	2.000	PZ																																																																																																																			
TB3009B0	TB3132A-L=67 0MM EPDM BIANCO BLU	2.000	PZ																																																																																																																			
TB3225B0	TB2820A-TUB O EPDM NERO 670MM	2.000	PZ																																																																																																																			
VH1220A1	VITE AUTOFIL. 4.2X11 TCS+ MARUTEX	2.000	PZ																																																																																																																			
VL1019A0	POMPA DETERGENTE VIBRAZIONE		2.000	PZ																																																																																																																		
VL1047A1	PORTAGOMM A D6 CODOLO D8		2.000	PZ																																																																																																																		
VL1054B0	DISTRIBUTOR E INGRESSI LAVAGGIO ON		2.000	PZ																																																																																																																		
VL1102A1	FILTRO IN LINEA DET. + VNR BARBED 6 MM		2.000	PZ																																																																																																																		
VL1127A1	RACCORDO A T BARBED 6		1.000	PZ																																																																																																																		
VL1128A1	VALVOLA VNR BARBED D6		4.000	PZ																																																																																																																		
VL1166A0	RACCORDO A L BAM-BB6		2.000	PZ																																																																																																																		
VL1174C0	UGELLO CALIBRATO D1.2 MM		2.000	PZ																																																																																																																		
VL1191A0	DISTRIBUTOR E USCITA LAVAGGIO ON		2.000	PZ																																																																																																																		
VL1214A0	VALVOLA VNR BB6-BAIONET TA		2.000	PZ																																																																																																																		
VM2172A0	CLIP BLOCCAGGIO POMPA CON CIRCUITO		4.000	PZ																																																																																																																		

COMPONENT			SPARE PART																																																																																		
Code	Description	Image	Code	Description	Kit components																																																																																
VL1019A	POMPA DETERGENTE VIBRAZIONE		KVL1225A	US HOOD WASHING SYSTEM KIT	<table border="1"> <thead> <tr> <th>Code</th> <th>Description</th> <th>Qty</th> <th>UOM</th> </tr> </thead> <tbody> <tr> <td>0H2213A1</td> <td>LAMIERA IMPIANTO IDRICO CAPPÀ</td> <td>1.000</td> <td>PZ</td> </tr> <tr> <td>EL1346A0</td> <td>CLIP BLOCCA PINZETTA RACCORDI D10 TIERRE</td> <td>2.000</td> <td>PZ</td> </tr> <tr> <td>EL1450A0</td> <td>ELETTROVALV OLA H2O AUTOPULENT E BAF USA</td> <td>2.000</td> <td>PZ</td> </tr> <tr> <td>GN1526A0</td> <td>O-RING D.INT6.9 SP1.8</td> <td>5.000</td> <td>PZ</td> </tr> <tr> <td>RC1019A0</td> <td>FASCETTA ELASTICA D10 ZINCATA</td> <td>14.000</td> <td>PZ</td> </tr> <tr> <td>RC1131A0</td> <td>FASCETTA 200X2.6 BIANC</td> <td>1.000</td> <td>PZ</td> </tr> <tr> <td>RC1242A0</td> <td>TERMINALE CHIUSO D10</td> <td>2.000</td> <td>PZ</td> </tr> <tr> <td>RC1414A1</td> <td>FASCETTA STRINGITUBO A SCATTO D11.5-12.5</td> <td>4.000</td> <td>PZ</td> </tr> <tr> <td>TB2821A0</td> <td>TB2820A-L=40 MM EPDM NER</td> <td>4.000</td> <td>PZ</td> </tr> <tr> <td>TB2994A0</td> <td>TB2820A-TUB O EPDM NERO 1000MM</td> <td>2.000</td> <td>PZ</td> </tr> <tr> <td>TB3252A0</td> <td>TB3132A-L=23 0MM EPDM BIANCO BLU</td> <td>2.000</td> <td>PZ</td> </tr> <tr> <td>TB3614A0</td> <td>TB2820A-L=96 MM NERO EPD</td> <td>1.000</td> <td>PZ</td> </tr> <tr> <td>VI1220A1</td> <td>VITE AUTOFIL. 4.2X11 TCS+ MARUTEX</td> <td>3.000</td> <td>PZ</td> </tr> <tr> <td>VI2070A0</td> <td>VITE AUTOFIL. 40X8 TCB+ SHEETTRACS</td> <td>2.000</td> <td>PZ</td> </tr> <tr> <td>VL1019A0</td> <td>POMPA DETERGENTE VIBRAZIONE</td> <td>1.000</td> <td>PZ</td> </tr> <tr> <td>VL1047A1</td> <td>PORTAGOMM A D6 CODOLO D8</td> <td>1.000</td> <td>PZ</td> </tr> <tr> <td>VL1054B0</td> <td>DISTRIBUTOR E INGRESSI LAVAGGIO ON</td> <td>1.000</td> <td>PZ</td> </tr> <tr> <td>VL1102A1</td> <td>FILTRO IN LINEA DET. + VNR BARBED 6 MM</td> <td>1.000</td> <td>PZ</td> </tr> <tr> <td>VL1127A1</td> <td>RACCORDO A T BARBED 6</td> <td>1.000</td> <td>PZ</td> </tr> </tbody> </table>	Code	Description	Qty	UOM	0H2213A1	LAMIERA IMPIANTO IDRICO CAPPÀ	1.000	PZ	EL1346A0	CLIP BLOCCA PINZETTA RACCORDI D10 TIERRE	2.000	PZ	EL1450A0	ELETTROVALV OLA H2O AUTOPULENT E BAF USA	2.000	PZ	GN1526A0	O-RING D.INT6.9 SP1.8	5.000	PZ	RC1019A0	FASCETTA ELASTICA D10 ZINCATA	14.000	PZ	RC1131A0	FASCETTA 200X2.6 BIANC	1.000	PZ	RC1242A0	TERMINALE CHIUSO D10	2.000	PZ	RC1414A1	FASCETTA STRINGITUBO A SCATTO D11.5-12.5	4.000	PZ	TB2821A0	TB2820A-L=40 MM EPDM NER	4.000	PZ	TB2994A0	TB2820A-TUB O EPDM NERO 1000MM	2.000	PZ	TB3252A0	TB3132A-L=23 0MM EPDM BIANCO BLU	2.000	PZ	TB3614A0	TB2820A-L=96 MM NERO EPD	1.000	PZ	VI1220A1	VITE AUTOFIL. 4.2X11 TCS+ MARUTEX	3.000	PZ	VI2070A0	VITE AUTOFIL. 40X8 TCB+ SHEETTRACS	2.000	PZ	VL1019A0	POMPA DETERGENTE VIBRAZIONE	1.000	PZ	VL1047A1	PORTAGOMM A D6 CODOLO D8	1.000	PZ	VL1054B0	DISTRIBUTOR E INGRESSI LAVAGGIO ON	1.000	PZ	VL1102A1	FILTRO IN LINEA DET. + VNR BARBED 6 MM	1.000	PZ	VL1127A1	RACCORDO A T BARBED 6	1.000	PZ
					Code	Description	Qty	UOM																																																																													
					0H2213A1	LAMIERA IMPIANTO IDRICO CAPPÀ	1.000	PZ																																																																													
					EL1346A0	CLIP BLOCCA PINZETTA RACCORDI D10 TIERRE	2.000	PZ																																																																													
					EL1450A0	ELETTROVALV OLA H2O AUTOPULENT E BAF USA	2.000	PZ																																																																													
					GN1526A0	O-RING D.INT6.9 SP1.8	5.000	PZ																																																																													
					RC1019A0	FASCETTA ELASTICA D10 ZINCATA	14.000	PZ																																																																													
					RC1131A0	FASCETTA 200X2.6 BIANC	1.000	PZ																																																																													
					RC1242A0	TERMINALE CHIUSO D10	2.000	PZ																																																																													
					RC1414A1	FASCETTA STRINGITUBO A SCATTO D11.5-12.5	4.000	PZ																																																																													
					TB2821A0	TB2820A-L=40 MM EPDM NER	4.000	PZ																																																																													
					TB2994A0	TB2820A-TUB O EPDM NERO 1000MM	2.000	PZ																																																																													
					TB3252A0	TB3132A-L=23 0MM EPDM BIANCO BLU	2.000	PZ																																																																													
					TB3614A0	TB2820A-L=96 MM NERO EPD	1.000	PZ																																																																													
					VI1220A1	VITE AUTOFIL. 4.2X11 TCS+ MARUTEX	3.000	PZ																																																																													
					VI2070A0	VITE AUTOFIL. 40X8 TCB+ SHEETTRACS	2.000	PZ																																																																													
					VL1019A0	POMPA DETERGENTE VIBRAZIONE	1.000	PZ																																																																													
					VL1047A1	PORTAGOMM A D6 CODOLO D8	1.000	PZ																																																																													
					VL1054B0	DISTRIBUTOR E INGRESSI LAVAGGIO ON	1.000	PZ																																																																													
					VL1102A1	FILTRO IN LINEA DET. + VNR BARBED 6 MM	1.000	PZ																																																																													
VL1127A1	RACCORDO A T BARBED 6	1.000	PZ																																																																																		

COMPONENT			SPARE PART																																											
Code	Description	Image	Code	Description	Kit components																																									
VL1019A	POMPA DETERGENTE VIBRAZIONE		KVL1225A	US HOOD WASHING SYSTEM KIT	<table border="1"> <thead> <tr> <th>Code</th> <th>Description</th> <th>Qty</th> <th>UOM</th> </tr> </thead> <tbody> <tr> <td>VL1128A1</td> <td>VALVOLA VNR BARBED D6</td> <td>1.000</td> <td>PZ</td> </tr> <tr> <td>VL1165A0</td> <td>RACCORDO DRITTO BAM-BB6</td> <td>1.000</td> <td>PZ</td> </tr> <tr> <td>VL1166A0</td> <td>RACCORDO A L BAM-BB6</td> <td>2.000</td> <td>PZ</td> </tr> <tr> <td>VL1174C0</td> <td>UGELLO CALIBRATO D1.2 MM</td> <td>1.000</td> <td>PZ</td> </tr> <tr> <td>VL1191A0</td> <td>DISTRIBUTOR E USCITA LAVAGGIO ON</td> <td>1.000</td> <td>PZ</td> </tr> <tr> <td>VL1214A0</td> <td>VALVOLA VNR BB6-BAIONET TA</td> <td>1.000</td> <td>PZ</td> </tr> <tr> <td>VM1605A0</td> <td>CLIP TWIST LOCK DIAM. 10,2-12,7 MM</td> <td>2.000</td> <td>PZ</td> </tr> <tr> <td>VM2172A0</td> <td>CLIP BLOCCAGGIO POMPA CON CIRCUITO</td> <td>3.000</td> <td>PZ</td> </tr> </tbody> </table>	Code	Description	Qty	UOM	VL1128A1	VALVOLA VNR BARBED D6	1.000	PZ	VL1165A0	RACCORDO DRITTO BAM-BB6	1.000	PZ	VL1166A0	RACCORDO A L BAM-BB6	2.000	PZ	VL1174C0	UGELLO CALIBRATO D1.2 MM	1.000	PZ	VL1191A0	DISTRIBUTOR E USCITA LAVAGGIO ON	1.000	PZ	VL1214A0	VALVOLA VNR BB6-BAIONET TA	1.000	PZ	VM1605A0	CLIP TWIST LOCK DIAM. 10,2-12,7 MM	2.000	PZ	VM2172A0	CLIP BLOCCAGGIO POMPA CON CIRCUITO	3.000	PZ					
			Code	Description	Qty	UOM																																								
VL1128A1	VALVOLA VNR BARBED D6	1.000	PZ																																											
VL1165A0	RACCORDO DRITTO BAM-BB6	1.000	PZ																																											
VL1166A0	RACCORDO A L BAM-BB6	2.000	PZ																																											
VL1174C0	UGELLO CALIBRATO D1.2 MM	1.000	PZ																																											
VL1191A0	DISTRIBUTOR E USCITA LAVAGGIO ON	1.000	PZ																																											
VL1214A0	VALVOLA VNR BB6-BAIONET TA	1.000	PZ																																											
VM1605A0	CLIP TWIST LOCK DIAM. 10,2-12,7 MM	2.000	PZ																																											
VM2172A0	CLIP BLOCCAGGIO POMPA CON CIRCUITO	3.000	PZ																																											
KVL1222A	EUR 0311 ONE PLUS CLEANING SYSTEM KIT	<table border="1"> <thead> <tr> <th>Code</th> <th>Description</th> <th>Qty</th> <th>UOM</th> </tr> </thead> <tbody> <tr> <td>0H2486A0</td> <td>LAMIERA IMPIANTO LAVAGGIO 031</td> <td>1.000</td> <td>PZ</td> </tr> <tr> <td>EL1346A0</td> <td>CLIP BLOCCA PINZETTA RACCORDI D10 TIERRE</td> <td>2.000</td> <td>PZ</td> </tr> <tr> <td>EL1440A0</td> <td>ELETTROVALV OLA H2O AUTOPULENT E BAF EU</td> <td>1.000</td> <td>PZ</td> </tr> <tr> <td>GN1526A0</td> <td>O-RING D.INT6.9 SP1.8</td> <td>3.000</td> <td>PZ</td> </tr> <tr> <td>RC1019A0</td> <td>FASCETTA ELASTICA D10 ZINCATA</td> <td>12.000</td> <td>PZ</td> </tr> <tr> <td>RC1242A0</td> <td>TERMINALE CHIUSO D10</td> <td>2.000</td> <td>PZ</td> </tr> <tr> <td>RC1414A1</td> <td>FASCETTA STRINGITUBO A SCATTO D11.5-12.5</td> <td>1.000</td> <td>PZ</td> </tr> <tr> <td>TB2821A0</td> <td>TB2820A-L=40 MM EPDM NER</td> <td>4.000</td> <td>PZ</td> </tr> <tr> <td>TB3004A0</td> <td>TB2820A-L=57 0MM EPDM NERO</td> <td>1.000</td> <td>PZ</td> </tr> <tr> <td>TB3009B0</td> <td>TB3132A-L=67 0MM EPDM BIANCO BLU</td> <td>1.000</td> <td>PZ</td> </tr> </tbody> </table>	Code	Description	Qty	UOM	0H2486A0	LAMIERA IMPIANTO LAVAGGIO 031	1.000	PZ	EL1346A0	CLIP BLOCCA PINZETTA RACCORDI D10 TIERRE	2.000	PZ	EL1440A0	ELETTROVALV OLA H2O AUTOPULENT E BAF EU	1.000	PZ	GN1526A0	O-RING D.INT6.9 SP1.8	3.000	PZ	RC1019A0	FASCETTA ELASTICA D10 ZINCATA	12.000	PZ	RC1242A0	TERMINALE CHIUSO D10	2.000	PZ	RC1414A1	FASCETTA STRINGITUBO A SCATTO D11.5-12.5	1.000	PZ	TB2821A0	TB2820A-L=40 MM EPDM NER	4.000	PZ	TB3004A0	TB2820A-L=57 0MM EPDM NERO	1.000	PZ	TB3009B0	TB3132A-L=67 0MM EPDM BIANCO BLU	1.000	PZ
Code	Description	Qty	UOM																																											
0H2486A0	LAMIERA IMPIANTO LAVAGGIO 031	1.000	PZ																																											
EL1346A0	CLIP BLOCCA PINZETTA RACCORDI D10 TIERRE	2.000	PZ																																											
EL1440A0	ELETTROVALV OLA H2O AUTOPULENT E BAF EU	1.000	PZ																																											
GN1526A0	O-RING D.INT6.9 SP1.8	3.000	PZ																																											
RC1019A0	FASCETTA ELASTICA D10 ZINCATA	12.000	PZ																																											
RC1242A0	TERMINALE CHIUSO D10	2.000	PZ																																											
RC1414A1	FASCETTA STRINGITUBO A SCATTO D11.5-12.5	1.000	PZ																																											
TB2821A0	TB2820A-L=40 MM EPDM NER	4.000	PZ																																											
TB3004A0	TB2820A-L=57 0MM EPDM NERO	1.000	PZ																																											
TB3009B0	TB3132A-L=67 0MM EPDM BIANCO BLU	1.000	PZ																																											

COMPONENT			SPARE PART																																																																																	
Code	Description	Image	Code	Description	Kit components																																																																															
VL1019A	POMPA DETERGENTE VIBRAZIONE		KVL1222A	EUR 0311 ONE PLUS CLEANING SYSTEM KIT	<table border="1"> <thead> <tr> <th>Code</th> <th>Description</th> <th>Qty</th> <th>UOM</th> </tr> </thead> <tbody> <tr> <td>TB3225B0</td> <td>TB2820A-TUB O EPDM NERO 670MM</td> <td>1.000</td> <td>PZ</td> </tr> <tr> <td>TB3614A0</td> <td>TB2820A-L=96 MM NERO EPD</td> <td>1.000</td> <td>PZ</td> </tr> <tr> <td>VI1220A1</td> <td>VITE AUTOFIL. 4.2X11 TCS+ MARUTEX</td> <td>4.000</td> <td>PZ</td> </tr> <tr> <td>VI2070A0</td> <td>VITE AUTOFIL. 40X8 TCB+ SHEETTRACS</td> <td>2.000</td> <td>PZ</td> </tr> <tr> <td>VL1019A0</td> <td>POMPA DETERGENTE VIBRAZIONE</td> <td>1.000</td> <td>PZ</td> </tr> <tr> <td>VL1047A1</td> <td>PORTAGOMM A D6 CODOLO D8</td> <td>1.000</td> <td>PZ</td> </tr> <tr> <td>VL1054B0</td> <td>DISTRIBUTOR E INGRESSI LAVAGGIO ON</td> <td>1.000</td> <td>PZ</td> </tr> <tr> <td>VL1102A1</td> <td>FILTRO IN LINEA DET. + VNR BARBED 6 MM</td> <td>1.000</td> <td>PZ</td> </tr> <tr> <td>VL1128A1</td> <td>VALVOLA VNR BARBED D6</td> <td>1.000</td> <td>PZ</td> </tr> <tr> <td>VL1166A0</td> <td>RACCORDO A L BAMB-BB6</td> <td>1.000</td> <td>PZ</td> </tr> <tr> <td>VL1174C0</td> <td>UGELLO CALIBRATO D1.2 MM</td> <td>1.000</td> <td>PZ</td> </tr> <tr> <td>VL1191A0</td> <td>DISTRIBUTOR E USCITA LAVAGGIO ON</td> <td>1.000</td> <td>PZ</td> </tr> <tr> <td>VL1214A0</td> <td>VALVOLA VNR BB6-BAIONET TA</td> <td>1.000</td> <td>PZ</td> </tr> <tr> <td>VM2172A0</td> <td>CLIP BLOCCAGGIO POMPA CON CIRCUITO</td> <td>2.000</td> <td>PZ</td> </tr> </tbody> </table>	Code	Description	Qty	UOM	TB3225B0	TB2820A-TUB O EPDM NERO 670MM	1.000	PZ	TB3614A0	TB2820A-L=96 MM NERO EPD	1.000	PZ	VI1220A1	VITE AUTOFIL. 4.2X11 TCS+ MARUTEX	4.000	PZ	VI2070A0	VITE AUTOFIL. 40X8 TCB+ SHEETTRACS	2.000	PZ	VL1019A0	POMPA DETERGENTE VIBRAZIONE	1.000	PZ	VL1047A1	PORTAGOMM A D6 CODOLO D8	1.000	PZ	VL1054B0	DISTRIBUTOR E INGRESSI LAVAGGIO ON	1.000	PZ	VL1102A1	FILTRO IN LINEA DET. + VNR BARBED 6 MM	1.000	PZ	VL1128A1	VALVOLA VNR BARBED D6	1.000	PZ	VL1166A0	RACCORDO A L BAMB-BB6	1.000	PZ	VL1174C0	UGELLO CALIBRATO D1.2 MM	1.000	PZ	VL1191A0	DISTRIBUTOR E USCITA LAVAGGIO ON	1.000	PZ	VL1214A0	VALVOLA VNR BB6-BAIONET TA	1.000	PZ	VM2172A0	CLIP BLOCCAGGIO POMPA CON CIRCUITO	2.000	PZ	KVL1213A	US PLUS COMPACT WASHING SYSTEM KIT	<table border="1"> <thead> <tr> <th>Code</th> <th>Description</th> <th>Qty</th> <th>UOM</th> </tr> </thead> <tbody> <tr> <td>0H2428A2</td> <td>LAMIERA IMPIANTO LAVAGGIO XECC PLUS</td> <td>1.000</td> <td>PZ</td> </tr> <tr> <td>EL1346A0</td> <td>CLIP BLOCCA PINZETTA RACCORDI D10 TIERRE</td> <td>2.000</td> <td>PZ</td> </tr> <tr> <td>EL1450A0</td> <td>ELETTROVALV OLA H2O AUTOPULENT E BAF USA</td> <td>3.000</td> <td>PZ</td> </tr> </tbody> </table>	Code	Description	Qty	UOM	0H2428A2	LAMIERA IMPIANTO LAVAGGIO XECC PLUS	1.000	PZ	EL1346A0	CLIP BLOCCA PINZETTA RACCORDI D10 TIERRE	2.000	PZ	EL1450A0	ELETTROVALV OLA H2O AUTOPULENT E BAF USA	3.000	PZ
			Code		Description	Qty	UOM																																																																													
TB3225B0	TB2820A-TUB O EPDM NERO 670MM	1.000	PZ																																																																																	
TB3614A0	TB2820A-L=96 MM NERO EPD	1.000	PZ																																																																																	
VI1220A1	VITE AUTOFIL. 4.2X11 TCS+ MARUTEX	4.000	PZ																																																																																	
VI2070A0	VITE AUTOFIL. 40X8 TCB+ SHEETTRACS	2.000	PZ																																																																																	
VL1019A0	POMPA DETERGENTE VIBRAZIONE	1.000	PZ																																																																																	
VL1047A1	PORTAGOMM A D6 CODOLO D8	1.000	PZ																																																																																	
VL1054B0	DISTRIBUTOR E INGRESSI LAVAGGIO ON	1.000	PZ																																																																																	
VL1102A1	FILTRO IN LINEA DET. + VNR BARBED 6 MM	1.000	PZ																																																																																	
VL1128A1	VALVOLA VNR BARBED D6	1.000	PZ																																																																																	
VL1166A0	RACCORDO A L BAMB-BB6	1.000	PZ																																																																																	
VL1174C0	UGELLO CALIBRATO D1.2 MM	1.000	PZ																																																																																	
VL1191A0	DISTRIBUTOR E USCITA LAVAGGIO ON	1.000	PZ																																																																																	
VL1214A0	VALVOLA VNR BB6-BAIONET TA	1.000	PZ																																																																																	
VM2172A0	CLIP BLOCCAGGIO POMPA CON CIRCUITO	2.000	PZ																																																																																	
Code	Description	Qty	UOM																																																																																	
0H2428A2	LAMIERA IMPIANTO LAVAGGIO XECC PLUS	1.000	PZ																																																																																	
EL1346A0	CLIP BLOCCA PINZETTA RACCORDI D10 TIERRE	2.000	PZ																																																																																	
EL1450A0	ELETTROVALV OLA H2O AUTOPULENT E BAF USA	3.000	PZ																																																																																	

COMPONENT			SPARE PART			
Code	Description	Image	Code	Description	Kit components	
VL1019A	POMPA DETERGENTE VIBRAZIONE		KVL1213A	US PLUS COMPACT WASHING SYSTEM KIT	Code	Description Qty UOM
					GN1311A0	PASSACAVO GOMMA DE=25 DI=12 SP=6.5 1.000 PZ
					GN1526A0	O-RING D.INT6.9 SP1.8 7.000 PZ
					RC1018A0	FASCETTA ELASTICA D12 ZINCATA 5.000 PZ
					RC1019A0	FASCETTA ELASTICA D10 ZINCATA 14.000 PZ
					RC1130A0	FASCETTA 130X2,6 1.000 PZ
					RC1131A0	FASCETTA 200X2,6 BIANCO 1.000 PZ
					RC1242A0	TERMINALE CHIUSO D10 2.000 PZ
					RC1356A0	RACCORDO DRITTO FIL. FEMM 8X1/4 BSP 1.000 PZ
					RC1414A1	FASCETTA STRINGITUBO A SCATTO D11.5-12.5 4.000 PZ
					TB2821A0	TB2820A-L=40 6.000 PZ MM EPDM NER
					TB3004A0	TB2820A-L=57 2.000 PZ 0MM EPDM NERO
					TB3005B0	TB3132A-L=55 1.000 PZ 0MM EPDM BIANCO BLU
					TB3252A0	TB3132A-L=23 1.000 PZ 0MM EPDM BIANCO BLU
					TB3469A0	TB3132A-L=38 1.000 PZ 0MM EPDM BIANCO-BLU
					VH1220A1	VITE AUTOFIL. 4.2X11 TCS+ MARUTEX 3.000 PZ
					VL1019A0	POMPA DETERGENTE VIBRAZIONE 1.000 PZ
					VL1047A1	PORTAGOMM A D6 CODOLO D8 1.000 PZ
					VL1054B0	DISTRIBUTOR E INGRESSI LAVAGGIO ON 1.000 PZ

COMPONENT			SPARE PART																																										
Code	Description	Image	Code	Description	Kit components																																								
VL1019A	POMPA DETERGENTE VIBRAZIONE		KVL1213A	US PLUS COMPACT WASHING SYSTEM KIT	<table border="1"> <thead> <tr> <th>Code</th> <th>Description</th> <th>Qty</th> <th>UOM</th> </tr> </thead> <tbody> <tr> <td>VL1102A1</td> <td>FILTRO IN LINEA DET. + VNR BARBED 6 MM</td> <td>1.000</td> <td>PZ</td> </tr> <tr> <td>VL1127A1</td> <td>RACCORDO A T BARBED 6</td> <td>1.000</td> <td>PZ</td> </tr> <tr> <td>VL1128A1</td> <td>VALVOLA VNR BARBED D6</td> <td>2.000</td> <td>PZ</td> </tr> <tr> <td>VL1165A0</td> <td>RACCORDO DRITTO BAM-BB6</td> <td>1.000</td> <td>PZ</td> </tr> <tr> <td>VL1166A0</td> <td>RACCORDO A L BAM-BB6</td> <td>3.000</td> <td>PZ</td> </tr> <tr> <td>VL1174C0</td> <td>UGELLO CALIBRATO D1.2 MM</td> <td>1.000</td> <td>PZ</td> </tr> <tr> <td>VL1185A0</td> <td>DISTRIBUTORE E LAVAGGIO PLUS 2 VIE UGELLO</td> <td>1.000</td> <td>PZ</td> </tr> <tr> <td>VL1398A0</td> <td>PRESSOSTAT O.N.O. 1/4 M CI</td> <td>1.000</td> <td>PZ</td> </tr> <tr> <td>VM2172A0</td> <td>CLIP BLOCCAGGIO POMPA CON CIRCUITO</td> <td>3.000</td> <td>PZ</td> </tr> </tbody> </table>	Code	Description	Qty	UOM	VL1102A1	FILTRO IN LINEA DET. + VNR BARBED 6 MM	1.000	PZ	VL1127A1	RACCORDO A T BARBED 6	1.000	PZ	VL1128A1	VALVOLA VNR BARBED D6	2.000	PZ	VL1165A0	RACCORDO DRITTO BAM-BB6	1.000	PZ	VL1166A0	RACCORDO A L BAM-BB6	3.000	PZ	VL1174C0	UGELLO CALIBRATO D1.2 MM	1.000	PZ	VL1185A0	DISTRIBUTORE E LAVAGGIO PLUS 2 VIE UGELLO	1.000	PZ	VL1398A0	PRESSOSTAT O.N.O. 1/4 M CI	1.000	PZ	VM2172A0	CLIP BLOCCAGGIO POMPA CON CIRCUITO	3.000	PZ
Code	Description	Qty	UOM																																										
VL1102A1	FILTRO IN LINEA DET. + VNR BARBED 6 MM	1.000	PZ																																										
VL1127A1	RACCORDO A T BARBED 6	1.000	PZ																																										
VL1128A1	VALVOLA VNR BARBED D6	2.000	PZ																																										
VL1165A0	RACCORDO DRITTO BAM-BB6	1.000	PZ																																										
VL1166A0	RACCORDO A L BAM-BB6	3.000	PZ																																										
VL1174C0	UGELLO CALIBRATO D1.2 MM	1.000	PZ																																										
VL1185A0	DISTRIBUTORE E LAVAGGIO PLUS 2 VIE UGELLO	1.000	PZ																																										
VL1398A0	PRESSOSTAT O.N.O. 1/4 M CI	1.000	PZ																																										
VM2172A0	CLIP BLOCCAGGIO POMPA CON CIRCUITO	3.000	PZ																																										
			KVL1212A	EUR COMPACT PLUS CLEANING SYSTEM KIT	<table border="1"> <thead> <tr> <th>Code</th> <th>Description</th> <th>Qty</th> <th>UOM</th> </tr> </thead> <tbody> <tr> <td>0H2428A2</td> <td>LAMIERA IMPIANTO LAVAGGIO XECC PLUS</td> <td>1.000</td> <td>PZ</td> </tr> <tr> <td>EL1346A0</td> <td>CLIP BLOCCA PINZETTA RACCORDI D10 TIERRE</td> <td>2.000</td> <td>PZ</td> </tr> <tr> <td>EL1440A0</td> <td>ELETTROVALV OLA H2O AUTOPULENT E BAF EU</td> <td>3.000</td> <td>PZ</td> </tr> <tr> <td>GN1311A0</td> <td>PASSACAVO GOMMA DE=25 DI=12 SP=6.5</td> <td>1.000</td> <td>PZ</td> </tr> <tr> <td>GN1526A0</td> <td>O-RING D.INT6.9 SP1.8</td> <td>7.000</td> <td>PZ</td> </tr> <tr> <td>RC1018A0</td> <td>FASCETTA ELASTICA D12 ZINCATA</td> <td>5.000</td> <td>PZ</td> </tr> <tr> <td>RC1019A0</td> <td>FASCETTA ELASTICA D10 ZINCATA</td> <td>14.000</td> <td>PZ</td> </tr> <tr> <td>RC1130A0</td> <td>FASCETTA 130X2,6</td> <td>1.000</td> <td>PZ</td> </tr> </tbody> </table>	Code	Description	Qty	UOM	0H2428A2	LAMIERA IMPIANTO LAVAGGIO XECC PLUS	1.000	PZ	EL1346A0	CLIP BLOCCA PINZETTA RACCORDI D10 TIERRE	2.000	PZ	EL1440A0	ELETTROVALV OLA H2O AUTOPULENT E BAF EU	3.000	PZ	GN1311A0	PASSACAVO GOMMA DE=25 DI=12 SP=6.5	1.000	PZ	GN1526A0	O-RING D.INT6.9 SP1.8	7.000	PZ	RC1018A0	FASCETTA ELASTICA D12 ZINCATA	5.000	PZ	RC1019A0	FASCETTA ELASTICA D10 ZINCATA	14.000	PZ	RC1130A0	FASCETTA 130X2,6	1.000	PZ				
Code	Description	Qty	UOM																																										
0H2428A2	LAMIERA IMPIANTO LAVAGGIO XECC PLUS	1.000	PZ																																										
EL1346A0	CLIP BLOCCA PINZETTA RACCORDI D10 TIERRE	2.000	PZ																																										
EL1440A0	ELETTROVALV OLA H2O AUTOPULENT E BAF EU	3.000	PZ																																										
GN1311A0	PASSACAVO GOMMA DE=25 DI=12 SP=6.5	1.000	PZ																																										
GN1526A0	O-RING D.INT6.9 SP1.8	7.000	PZ																																										
RC1018A0	FASCETTA ELASTICA D12 ZINCATA	5.000	PZ																																										
RC1019A0	FASCETTA ELASTICA D10 ZINCATA	14.000	PZ																																										
RC1130A0	FASCETTA 130X2,6	1.000	PZ																																										

COMPONENT			SPARE PART																																																																																											
Code	Description	Image	Code	Description	Kit components																																																																																									
VL1019A	POMPA DETERGENTE VIBRAZIONE		KVL1212A	EUR COMPACT PLUS CLEANING SYSTEM KIT	<table border="1"> <thead> <tr> <th>Code</th> <th>Description</th> <th>Qty</th> <th>UOM</th> </tr> </thead> <tbody> <tr> <td>RC1131A0</td> <td>FASCETTA 200X2,6 BIANC</td> <td>1.000</td> <td>PZ</td> </tr> <tr> <td>RC1242A0</td> <td>TERMINALE CHIUSO D10</td> <td>2.000</td> <td>PZ</td> </tr> <tr> <td>RC1356A0</td> <td>RACCORDO DRITTO FIL. FEMM 8X1/4 BSP</td> <td>1.000</td> <td>PZ</td> </tr> <tr> <td>RC1414A1</td> <td>FASCETTA STRINGITUBO A SCATTO D11,5-12,5</td> <td>4.000</td> <td>PZ</td> </tr> <tr> <td>TB2821A0</td> <td>TB2820A-L=40 MM EPDM NER</td> <td>6.000</td> <td>PZ</td> </tr> <tr> <td>TB3004A0</td> <td>TB2820A-L=57 0MM EPDM NERO</td> <td>2.000</td> <td>PZ</td> </tr> <tr> <td>TB3005B0</td> <td>TB3132A-L=55 0MM EPDM BIANCO BLU</td> <td>1.000</td> <td>PZ</td> </tr> <tr> <td>TB3252A0</td> <td>TB3132A-L=23 0MM EPDM BIANCO BLU</td> <td>1.000</td> <td>PZ</td> </tr> <tr> <td>TB3469A0</td> <td>TB3132A-L=38 0MM EPDM BIANCO-BLU</td> <td>1.000</td> <td>PZ</td> </tr> <tr> <td>VI1220A1</td> <td>VITE AUTOFIL. 4.2X11 TCS+ MARUTEX</td> <td>3.000</td> <td>PZ</td> </tr> <tr> <td>VL1019A0</td> <td>POMPA DETERGENTE VIBRAZIONE</td> <td></td> <td>1.000</td> <td>PZ</td> </tr> <tr> <td>VL1047A1</td> <td>PORTAGOMM A D6 CODOLO D8</td> <td></td> <td>1.000</td> <td>PZ</td> </tr> <tr> <td>VL1054B0</td> <td>DISTRIBUTOR E INGRESSI LAVAGGIO ON</td> <td></td> <td>1.000</td> <td>PZ</td> </tr> <tr> <td>VL1102A1</td> <td>FILTRO IN LINEA DET. + VNR BARBED 6 MM</td> <td></td> <td>1.000</td> <td>PZ</td> </tr> <tr> <td>VL1127A1</td> <td>RACCORDO A T BARBED 6</td> <td></td> <td>1.000</td> <td>PZ</td> </tr> <tr> <td>VL1128A1</td> <td>VALVOLA VNR BARBED D6</td> <td></td> <td>2.000</td> <td>PZ</td> </tr> <tr> <td>VL1165A0</td> <td>RACCORDO DRITTO BAM-BB6</td> <td></td> <td>1.000</td> <td>PZ</td> </tr> <tr> <td>VL1166A0</td> <td>RACCORDO A L BAM-BB6</td> <td></td> <td>3.000</td> <td>PZ</td> </tr> <tr> <td>VL1174C0</td> <td>UGELLO CALIBRATO D1,2 MM</td> <td></td> <td>1.000</td> <td>PZ</td> </tr> </tbody> </table>	Code	Description	Qty	UOM	RC1131A0	FASCETTA 200X2,6 BIANC	1.000	PZ	RC1242A0	TERMINALE CHIUSO D10	2.000	PZ	RC1356A0	RACCORDO DRITTO FIL. FEMM 8X1/4 BSP	1.000	PZ	RC1414A1	FASCETTA STRINGITUBO A SCATTO D11,5-12,5	4.000	PZ	TB2821A0	TB2820A-L=40 MM EPDM NER	6.000	PZ	TB3004A0	TB2820A-L=57 0MM EPDM NERO	2.000	PZ	TB3005B0	TB3132A-L=55 0MM EPDM BIANCO BLU	1.000	PZ	TB3252A0	TB3132A-L=23 0MM EPDM BIANCO BLU	1.000	PZ	TB3469A0	TB3132A-L=38 0MM EPDM BIANCO-BLU	1.000	PZ	VI1220A1	VITE AUTOFIL. 4.2X11 TCS+ MARUTEX	3.000	PZ	VL1019A0	POMPA DETERGENTE VIBRAZIONE		1.000	PZ	VL1047A1	PORTAGOMM A D6 CODOLO D8		1.000	PZ	VL1054B0	DISTRIBUTOR E INGRESSI LAVAGGIO ON		1.000	PZ	VL1102A1	FILTRO IN LINEA DET. + VNR BARBED 6 MM		1.000	PZ	VL1127A1	RACCORDO A T BARBED 6		1.000	PZ	VL1128A1	VALVOLA VNR BARBED D6		2.000	PZ	VL1165A0	RACCORDO DRITTO BAM-BB6		1.000	PZ	VL1166A0	RACCORDO A L BAM-BB6		3.000	PZ	VL1174C0	UGELLO CALIBRATO D1,2 MM		1.000	PZ
Code	Description	Qty	UOM																																																																																											
RC1131A0	FASCETTA 200X2,6 BIANC	1.000	PZ																																																																																											
RC1242A0	TERMINALE CHIUSO D10	2.000	PZ																																																																																											
RC1356A0	RACCORDO DRITTO FIL. FEMM 8X1/4 BSP	1.000	PZ																																																																																											
RC1414A1	FASCETTA STRINGITUBO A SCATTO D11,5-12,5	4.000	PZ																																																																																											
TB2821A0	TB2820A-L=40 MM EPDM NER	6.000	PZ																																																																																											
TB3004A0	TB2820A-L=57 0MM EPDM NERO	2.000	PZ																																																																																											
TB3005B0	TB3132A-L=55 0MM EPDM BIANCO BLU	1.000	PZ																																																																																											
TB3252A0	TB3132A-L=23 0MM EPDM BIANCO BLU	1.000	PZ																																																																																											
TB3469A0	TB3132A-L=38 0MM EPDM BIANCO-BLU	1.000	PZ																																																																																											
VI1220A1	VITE AUTOFIL. 4.2X11 TCS+ MARUTEX	3.000	PZ																																																																																											
VL1019A0	POMPA DETERGENTE VIBRAZIONE		1.000	PZ																																																																																										
VL1047A1	PORTAGOMM A D6 CODOLO D8		1.000	PZ																																																																																										
VL1054B0	DISTRIBUTOR E INGRESSI LAVAGGIO ON		1.000	PZ																																																																																										
VL1102A1	FILTRO IN LINEA DET. + VNR BARBED 6 MM		1.000	PZ																																																																																										
VL1127A1	RACCORDO A T BARBED 6		1.000	PZ																																																																																										
VL1128A1	VALVOLA VNR BARBED D6		2.000	PZ																																																																																										
VL1165A0	RACCORDO DRITTO BAM-BB6		1.000	PZ																																																																																										
VL1166A0	RACCORDO A L BAM-BB6		3.000	PZ																																																																																										
VL1174C0	UGELLO CALIBRATO D1,2 MM		1.000	PZ																																																																																										





COMPONENT			SPARE PART																																																											
Code	Description	Image	Code	Description	Kit components																																																									
VL1019A	POMPA DETERGENTE VIBRAZIONE		KVL1212A	EUR COMPACT PLUS CLEANING SYSTEM KIT	<table border="1"> <thead> <tr> <th>Code</th> <th>Description</th> <th>Qty</th> <th>UOM</th> </tr> </thead> <tbody> <tr> <td>VL1185A0</td> <td>DISTRIBUTOR E LAVAGGIO PLUS 2 VIE UGELLO</td> <td>1.000</td> <td>PZ</td> </tr> <tr> <td>VL1398A0</td> <td>PRESSOSTAT O.N.O. 1/4 M CI</td> <td>1.000</td> <td>PZ</td> </tr> <tr> <td>VM2172A0</td> <td>CLIP BLOCCAGGIO POMPA CON CIRCUITO</td> <td>3.000</td> <td>PZ</td> </tr> </tbody> </table>	Code	Description	Qty	UOM	VL1185A0	DISTRIBUTOR E LAVAGGIO PLUS 2 VIE UGELLO	1.000	PZ	VL1398A0	PRESSOSTAT O.N.O. 1/4 M CI	1.000	PZ	VM2172A0	CLIP BLOCCAGGIO POMPA CON CIRCUITO	3.000	PZ																																									
			Code	Description	Qty	UOM																																																								
VL1185A0	DISTRIBUTOR E LAVAGGIO PLUS 2 VIE UGELLO	1.000	PZ																																																											
VL1398A0	PRESSOSTAT O.N.O. 1/4 M CI	1.000	PZ																																																											
VM2172A0	CLIP BLOCCAGGIO POMPA CON CIRCUITO	3.000	PZ																																																											
KVL1211A	ONE COMPACT AND 0523-EP WASH. SYSTEM KIT	<table border="1"> <thead> <tr> <th>Code</th> <th>Description</th> <th>Qty</th> <th>UOM</th> </tr> </thead> <tbody> <tr> <td>0H2427A0</td> <td>LAMIERA IMPIANTO LAVAGGIO XECC</td> <td>1.000</td> <td>PZ</td> </tr> <tr> <td>EL1346A0</td> <td>CLIP BLOCCA PINZETTA RACCORDI D10 TIERRE</td> <td>2.000</td> <td>PZ</td> </tr> <tr> <td>EL1440A0</td> <td>ELETTROVALV OLA H2O AUTOPULENT E BAF EU</td> <td>1.000</td> <td>PZ</td> </tr> <tr> <td>GN1526A0</td> <td>O-RING D.INT6,9 SP1.8</td> <td>3.000</td> <td>PZ</td> </tr> <tr> <td>RC1018A0</td> <td>FASCETTA ELASTICA D12 ZINCATA</td> <td>4.000</td> <td>PZ</td> </tr> <tr> <td>RC1019A0</td> <td>FASCETTA ELASTICA D10 ZINCATA</td> <td>14.000</td> <td>PZ</td> </tr> <tr> <td>RC1130A0</td> <td>FASCETTA 130X2,6</td> <td>1.000</td> <td>PZ</td> </tr> <tr> <td>RC1242A0</td> <td>TERMINALE CHIUSO D10</td> <td>2.000</td> <td>PZ</td> </tr> <tr> <td>RC1414A1</td> <td>FASCETTA STRINGITUBO A SCATTO D11,5-12,5</td> <td>4.000</td> <td>PZ</td> </tr> <tr> <td>TB2821A0</td> <td>TB2820A-L=40 MM EPDM NER</td> <td>6.000</td> <td>PZ</td> </tr> <tr> <td>TB3004A0</td> <td>TB2820A-L=57 0MM EPDM NERO</td> <td>1.000</td> <td>PZ</td> </tr> <tr> <td>TB3252A0</td> <td>TB3132A-L=23 0MM EPDM BIANCO BLU</td> <td>1.000</td> <td>PZ</td> </tr> <tr> <td>TB3469A0</td> <td>TB3132A-L=38 0MM EPDM BIANCO-BLU</td> <td>1.000</td> <td>PZ</td> </tr> <tr> <td>VH1220A1</td> <td>VITE AUTOFIL. 4.2X11 TCS+ MARUTEX</td> <td>4.000</td> <td>PZ</td> </tr> </tbody> </table>	Code	Description	Qty	UOM	0H2427A0	LAMIERA IMPIANTO LAVAGGIO XECC	1.000	PZ	EL1346A0	CLIP BLOCCA PINZETTA RACCORDI D10 TIERRE	2.000	PZ	EL1440A0	ELETTROVALV OLA H2O AUTOPULENT E BAF EU	1.000	PZ	GN1526A0	O-RING D.INT6,9 SP1.8	3.000	PZ	RC1018A0	FASCETTA ELASTICA D12 ZINCATA	4.000	PZ	RC1019A0	FASCETTA ELASTICA D10 ZINCATA	14.000	PZ	RC1130A0	FASCETTA 130X2,6	1.000	PZ	RC1242A0	TERMINALE CHIUSO D10	2.000	PZ	RC1414A1	FASCETTA STRINGITUBO A SCATTO D11,5-12,5	4.000	PZ	TB2821A0	TB2820A-L=40 MM EPDM NER	6.000	PZ	TB3004A0	TB2820A-L=57 0MM EPDM NERO	1.000	PZ	TB3252A0	TB3132A-L=23 0MM EPDM BIANCO BLU	1.000	PZ	TB3469A0	TB3132A-L=38 0MM EPDM BIANCO-BLU	1.000	PZ	VH1220A1	VITE AUTOFIL. 4.2X11 TCS+ MARUTEX	4.000	PZ
Code	Description	Qty	UOM																																																											
0H2427A0	LAMIERA IMPIANTO LAVAGGIO XECC	1.000	PZ																																																											
EL1346A0	CLIP BLOCCA PINZETTA RACCORDI D10 TIERRE	2.000	PZ																																																											
EL1440A0	ELETTROVALV OLA H2O AUTOPULENT E BAF EU	1.000	PZ																																																											
GN1526A0	O-RING D.INT6,9 SP1.8	3.000	PZ																																																											
RC1018A0	FASCETTA ELASTICA D12 ZINCATA	4.000	PZ																																																											
RC1019A0	FASCETTA ELASTICA D10 ZINCATA	14.000	PZ																																																											
RC1130A0	FASCETTA 130X2,6	1.000	PZ																																																											
RC1242A0	TERMINALE CHIUSO D10	2.000	PZ																																																											
RC1414A1	FASCETTA STRINGITUBO A SCATTO D11,5-12,5	4.000	PZ																																																											
TB2821A0	TB2820A-L=40 MM EPDM NER	6.000	PZ																																																											
TB3004A0	TB2820A-L=57 0MM EPDM NERO	1.000	PZ																																																											
TB3252A0	TB3132A-L=23 0MM EPDM BIANCO BLU	1.000	PZ																																																											
TB3469A0	TB3132A-L=38 0MM EPDM BIANCO-BLU	1.000	PZ																																																											
VH1220A1	VITE AUTOFIL. 4.2X11 TCS+ MARUTEX	4.000	PZ																																																											

COMPONENT			SPARE PART																																																																																	
Code	Description	Image	Code	Description	Kit components																																																																															
VL1019A	POMPA DETERGENTE VIBRAZIONE		KVL1211A	ONE COMPACT AND 0523-EP WASH. SYSTEM KIT	<table border="1"> <thead> <tr> <th>Code</th> <th>Description</th> <th>Qty</th> <th>UOM</th> </tr> </thead> <tbody> <tr> <td>VL1019A0</td> <td>POMPA DETERGENTE VIBRAZIONE</td> <td>1.000</td> <td>PZ</td> </tr> <tr> <td>VL1047A1</td> <td>PORTAGOMM A D6 CODOLO D8</td> <td>1.000</td> <td>PZ</td> </tr> <tr> <td>VL1054B0</td> <td>DISTRIBUTOR E INGRESSI LAVAGGIO ON</td> <td>1.000</td> <td>PZ</td> </tr> <tr> <td>VL1102A1</td> <td>FILTRO IN LINEA DET. + VNR BARBED 6 MM</td> <td>1.000</td> <td>PZ</td> </tr> <tr> <td>VL1127A1</td> <td>RACCORDO A T BARBED 6</td> <td>1.000</td> <td>PZ</td> </tr> <tr> <td>VL1128A1</td> <td>VALVOLA VNR BARBED D6</td> <td>2.000</td> <td>PZ</td> </tr> <tr> <td>VL1165A0</td> <td>RACCORDO DRITTO BAM-BB6</td> <td>1.000</td> <td>PZ</td> </tr> <tr> <td>VL1166A0</td> <td>RACCORDO A L BAM-BB6</td> <td>1.000</td> <td>PZ</td> </tr> <tr> <td>VL1174C0</td> <td>UGELLO CALIBRATO D1.2 MM</td> <td>1.000</td> <td>PZ</td> </tr> <tr> <td>VL1191A0</td> <td>DISTRIBUTOR E USCITA LAVAGGIO ON</td> <td>1.000</td> <td>PZ</td> </tr> <tr> <td>VM2172A0</td> <td>CLIP BLOCCAGGIO POMPA CON CIRCUITO</td> <td>2.000</td> <td>PZ</td> </tr> </tbody> </table>	Code	Description	Qty	UOM	VL1019A0	POMPA DETERGENTE VIBRAZIONE	1.000	PZ	VL1047A1	PORTAGOMM A D6 CODOLO D8	1.000	PZ	VL1054B0	DISTRIBUTOR E INGRESSI LAVAGGIO ON	1.000	PZ	VL1102A1	FILTRO IN LINEA DET. + VNR BARBED 6 MM	1.000	PZ	VL1127A1	RACCORDO A T BARBED 6	1.000	PZ	VL1128A1	VALVOLA VNR BARBED D6	2.000	PZ	VL1165A0	RACCORDO DRITTO BAM-BB6	1.000	PZ	VL1166A0	RACCORDO A L BAM-BB6	1.000	PZ	VL1174C0	UGELLO CALIBRATO D1.2 MM	1.000	PZ	VL1191A0	DISTRIBUTOR E USCITA LAVAGGIO ON	1.000	PZ	VM2172A0	CLIP BLOCCAGGIO POMPA CON CIRCUITO	2.000	PZ	KVL1209A	US PLUS 3 ROTOR ARMS WASHING SYSTEM KIT	<table border="1"> <thead> <tr> <th>Code</th> <th>Description</th> <th>Qty</th> <th>UOM</th> </tr> </thead> <tbody> <tr> <td>0H2354A2</td> <td>LAMIERA IMPIANTO LAVAGGIO PLUS XEVC-XEVL</td> <td>1.000</td> <td>PZ</td> </tr> <tr> <td>EL1346A0</td> <td>CLIP BLOCCA PINZETTA RACCORDI D10 TIERRE</td> <td>2.000</td> <td>PZ</td> </tr> <tr> <td>EL1450A0</td> <td>ELETTROVALV OLA H2O AUTOPULENT E BAF USA</td> <td>4.000</td> <td>PZ</td> </tr> <tr> <td>GN1526A0</td> <td>O-RING D.INT6.9 SP1.8</td> <td>9.000</td> <td>PZ</td> </tr> <tr> <td>RC1018A0</td> <td>FASCETTA ELASTICA D12 ZINCATA</td> <td>11.000</td> <td>PZ</td> </tr> <tr> <td>RC1019A0</td> <td>FASCETTA ELASTICA D10 ZINCATA</td> <td>14.000</td> <td>PZ</td> </tr> </tbody> </table>	Code	Description	Qty	UOM	0H2354A2	LAMIERA IMPIANTO LAVAGGIO PLUS XEVC-XEVL	1.000	PZ	EL1346A0	CLIP BLOCCA PINZETTA RACCORDI D10 TIERRE	2.000	PZ	EL1450A0	ELETTROVALV OLA H2O AUTOPULENT E BAF USA	4.000	PZ	GN1526A0	O-RING D.INT6.9 SP1.8	9.000	PZ	RC1018A0	FASCETTA ELASTICA D12 ZINCATA	11.000	PZ	RC1019A0	FASCETTA ELASTICA D10 ZINCATA	14.000	PZ
			Code		Description	Qty	UOM																																																																													
VL1019A0	POMPA DETERGENTE VIBRAZIONE	1.000	PZ																																																																																	
VL1047A1	PORTAGOMM A D6 CODOLO D8	1.000	PZ																																																																																	
VL1054B0	DISTRIBUTOR E INGRESSI LAVAGGIO ON	1.000	PZ																																																																																	
VL1102A1	FILTRO IN LINEA DET. + VNR BARBED 6 MM	1.000	PZ																																																																																	
VL1127A1	RACCORDO A T BARBED 6	1.000	PZ																																																																																	
VL1128A1	VALVOLA VNR BARBED D6	2.000	PZ																																																																																	
VL1165A0	RACCORDO DRITTO BAM-BB6	1.000	PZ																																																																																	
VL1166A0	RACCORDO A L BAM-BB6	1.000	PZ																																																																																	
VL1174C0	UGELLO CALIBRATO D1.2 MM	1.000	PZ																																																																																	
VL1191A0	DISTRIBUTOR E USCITA LAVAGGIO ON	1.000	PZ																																																																																	
VM2172A0	CLIP BLOCCAGGIO POMPA CON CIRCUITO	2.000	PZ																																																																																	
Code	Description	Qty	UOM																																																																																	
0H2354A2	LAMIERA IMPIANTO LAVAGGIO PLUS XEVC-XEVL	1.000	PZ																																																																																	
EL1346A0	CLIP BLOCCA PINZETTA RACCORDI D10 TIERRE	2.000	PZ																																																																																	
EL1450A0	ELETTROVALV OLA H2O AUTOPULENT E BAF USA	4.000	PZ																																																																																	
GN1526A0	O-RING D.INT6.9 SP1.8	9.000	PZ																																																																																	
RC1018A0	FASCETTA ELASTICA D12 ZINCATA	11.000	PZ																																																																																	
RC1019A0	FASCETTA ELASTICA D10 ZINCATA	14.000	PZ																																																																																	

COMPONENT			SPARE PART																																																																																		
Code	Description	Image	Code	Description	Kit components																																																																																
VL1019A	POMPA DETERGENTE VIBRAZIONE		KVL1209A	US PLUS 3 ROTOR ARMS WASHING SYSTEM KIT	<table border="1"> <thead> <tr> <th>Code</th> <th>Description</th> <th>Qty</th> <th>UOM</th> </tr> </thead> <tbody> <tr> <td>RC1130A0</td> <td>FASCETTA 130X2,6</td> <td>1.000</td> <td>PZ</td> </tr> <tr> <td>RC1131A0</td> <td>FASCETTA 200X2,6 BIANCO</td> <td>3.000</td> <td>PZ</td> </tr> <tr> <td>RC1242A0</td> <td>TERMINALE CHIUSSO D10</td> <td>2.000</td> <td>PZ</td> </tr> <tr> <td>RC1356A0</td> <td>RACCORDO DRITTO FIL. FEMM 8X1/4 BSP</td> <td>1.000</td> <td>PZ</td> </tr> <tr> <td>RC1414A1</td> <td>FASCETTA STRINGITUBO A SCATTO D11.5-12.5</td> <td>1.000</td> <td>PZ</td> </tr> <tr> <td>TB2652A0</td> <td>TB3132A-L750 MM BIANCO BLU EPDM</td> <td>1.000</td> <td>PZ</td> </tr> <tr> <td>TB2677A0</td> <td>TB2820A-TUB O TANICA DET-FDET L1300MM</td> <td>1.000</td> <td>PZ</td> </tr> <tr> <td>TB2821A0</td> <td>TB2820A-L=40 MM EPDM NER</td> <td>4.000</td> <td>PZ</td> </tr> <tr> <td>TB3004A0</td> <td>TB2820A-L=57 0MM EPDM NERO</td> <td>2.000</td> <td>PZ</td> </tr> <tr> <td>TB3024C0</td> <td>TB3132A-TUB O BLU 6X12 L=55MM</td> <td>3.000</td> <td>PZ</td> </tr> <tr> <td>TB3226A0</td> <td>TB2820A-L110 MM COLLEGAMEN TO TANICA-LA</td> <td>1.000</td> <td>PZ</td> </tr> <tr> <td>TB3440A0</td> <td>TB3132A-L=10 50MM EPDM BIANCO-BLU</td> <td>1.000</td> <td>PZ</td> </tr> <tr> <td>TB3614A0</td> <td>TB2820A-L=96 MM NERO EPD</td> <td>1.000</td> <td>PZ</td> </tr> <tr> <td>VI1220A1</td> <td>VITE AUTOFIL. 4.2X11 TCS+ MARUTEX</td> <td>1.000</td> <td>PZ</td> </tr> <tr> <td>VL1019A0</td> <td>POMPA DETERGENTE VIBRAZIONE</td> <td>1.000</td> <td>PZ</td> </tr> <tr> <td>VL1102A1</td> <td>FILTRO IN LINEA DET. + VNR BARBED 6 MM</td> <td>1.000</td> <td>PZ</td> </tr> <tr> <td>VL1127A1</td> <td>RACCORDO A T BARBED 6</td> <td>2.000</td> <td>PZ</td> </tr> <tr> <td>VL1128A1</td> <td>VALVOLA VNR BARBED D6</td> <td>2.000</td> <td>PZ</td> </tr> <tr> <td>VL1166A0</td> <td>RACCORDO A L BAM-BB6</td> <td>4.000</td> <td>PZ</td> </tr> </tbody> </table>	Code	Description	Qty	UOM	RC1130A0	FASCETTA 130X2,6	1.000	PZ	RC1131A0	FASCETTA 200X2,6 BIANCO	3.000	PZ	RC1242A0	TERMINALE CHIUSSO D10	2.000	PZ	RC1356A0	RACCORDO DRITTO FIL. FEMM 8X1/4 BSP	1.000	PZ	RC1414A1	FASCETTA STRINGITUBO A SCATTO D11.5-12.5	1.000	PZ	TB2652A0	TB3132A-L750 MM BIANCO BLU EPDM	1.000	PZ	TB2677A0	TB2820A-TUB O TANICA DET-FDET L1300MM	1.000	PZ	TB2821A0	TB2820A-L=40 MM EPDM NER	4.000	PZ	TB3004A0	TB2820A-L=57 0MM EPDM NERO	2.000	PZ	TB3024C0	TB3132A-TUB O BLU 6X12 L=55MM	3.000	PZ	TB3226A0	TB2820A-L110 MM COLLEGAMEN TO TANICA-LA	1.000	PZ	TB3440A0	TB3132A-L=10 50MM EPDM BIANCO-BLU	1.000	PZ	TB3614A0	TB2820A-L=96 MM NERO EPD	1.000	PZ	VI1220A1	VITE AUTOFIL. 4.2X11 TCS+ MARUTEX	1.000	PZ	VL1019A0	POMPA DETERGENTE VIBRAZIONE	1.000	PZ	VL1102A1	FILTRO IN LINEA DET. + VNR BARBED 6 MM	1.000	PZ	VL1127A1	RACCORDO A T BARBED 6	2.000	PZ	VL1128A1	VALVOLA VNR BARBED D6	2.000	PZ	VL1166A0	RACCORDO A L BAM-BB6	4.000	PZ
					Code	Description	Qty	UOM																																																																													
					RC1130A0	FASCETTA 130X2,6	1.000	PZ																																																																													
					RC1131A0	FASCETTA 200X2,6 BIANCO	3.000	PZ																																																																													
					RC1242A0	TERMINALE CHIUSSO D10	2.000	PZ																																																																													
					RC1356A0	RACCORDO DRITTO FIL. FEMM 8X1/4 BSP	1.000	PZ																																																																													
					RC1414A1	FASCETTA STRINGITUBO A SCATTO D11.5-12.5	1.000	PZ																																																																													
					TB2652A0	TB3132A-L750 MM BIANCO BLU EPDM	1.000	PZ																																																																													
					TB2677A0	TB2820A-TUB O TANICA DET-FDET L1300MM	1.000	PZ																																																																													
					TB2821A0	TB2820A-L=40 MM EPDM NER	4.000	PZ																																																																													
					TB3004A0	TB2820A-L=57 0MM EPDM NERO	2.000	PZ																																																																													
					TB3024C0	TB3132A-TUB O BLU 6X12 L=55MM	3.000	PZ																																																																													
					TB3226A0	TB2820A-L110 MM COLLEGAMEN TO TANICA-LA	1.000	PZ																																																																													
					TB3440A0	TB3132A-L=10 50MM EPDM BIANCO-BLU	1.000	PZ																																																																													
					TB3614A0	TB2820A-L=96 MM NERO EPD	1.000	PZ																																																																													
					VI1220A1	VITE AUTOFIL. 4.2X11 TCS+ MARUTEX	1.000	PZ																																																																													
					VL1019A0	POMPA DETERGENTE VIBRAZIONE	1.000	PZ																																																																													
					VL1102A1	FILTRO IN LINEA DET. + VNR BARBED 6 MM	1.000	PZ																																																																													
					VL1127A1	RACCORDO A T BARBED 6	2.000	PZ																																																																													
					VL1128A1	VALVOLA VNR BARBED D6	2.000	PZ																																																																													
VL1166A0	RACCORDO A L BAM-BB6	4.000	PZ																																																																																		

COMPONENT			SPARE PART						
Code	Description	Image	Code	Description	Kit components				
VL1019A	POMPA DETERGENTE VIBRAZIONE		KVL1209A	US PLUS 3 ROTOR ARMS WASHING SYSTEM KIT	Code	Description	Qty	UOM	
					VL1167A2	FLOW RESTRICTOR 3 GIRANTI GN21 B-B	1.000	PZ	
	VL1174C0	UGELLO CALIBRATO D1.2 MM	1.000		PZ				
	VL1186A0	DISTRIBUTOR E LAVAGGIO PLUS 3 VIE UGELLO	1.000		PZ				
	VL1190A0	DISTRIBUTOR E INGRESSI LAVAGGIO PLUS	1.000		PZ				
	VL1214A0	VALVOLA VNR BB6-BAIONET TA	1.000		PZ				
	VL1398A0	PRESSOSTAT O.N.O. 1/4 M CI	1.000		PZ				
	VM1605A0	CLIP TWIST LOCK DIAM. 10,2-12,7 MM	3.000		PZ				
	VM2172A0	CLIP BLOCCAGGIO POMPA CON CIRCUITO	5.000		PZ				
					Code	Description	Qty	UOM	
			KVL1208A		US PLUS 2 ROTOR ARMS WASHING SYSTEM KIT	0H2354A2	LAMIERA IMPIANTO LAVAGGIO PLUS XEVC-XEVL	1.000	PZ
						EL1346A0	CLIP BLOCCA PINZETTA RACCORDI D10 TIERRE	2.000	PZ
						EL1450A0	ELETTROVALVOLA H2O AUTOPULENT E BAF USA	4.000	PZ
				GN1526A0		O-RING D.INT6.9 SP1.8	9.000	PZ	
				RC1018A0		FASCETTA ELASTICA D12 ZINCATA	3.000	PZ	
				RC1019A0		FASCETTA ELASTICA D10 ZINCATA	2.000	PZ	
				RC1130A0		FASCETTA 130X2,6	1.000	PZ	
				RC1131A0		FASCETTA 200X2,6 BIANC	3.000	PZ	

COMPONENT			SPARE PART					
Code	Description	Image	Code	Description	Kit components			
VL1019A	POMPA DETERGENTE VIBRAZIONE		KVL1208A	US PLUS 2 ROTOR ARMS WASHING SYSTEM KIT	Code	Description	Qty	UOM
					RC1242A0	TERMINALE CHIUSO D10	2.000	PZ
					RC1356A0	RACCORDO DRITTO FIL. FEMM 8X1/4 BSP	1.000	PZ
					RC1414A1	FASCETTA STRINGITUBO A SCATTO D11.5-12.5	4.000	PZ
					TB2821A0	TB2820A-L=40 MM EPDM NER	6.000	PZ
					TB2994A0	TB2820A-TUB O EPDM NERO 1000MM	1.000	PZ
					TB3004A0	TB2820A-L=57 0MM EPDM NERO	2.000	PZ
					TB3005B0	TB3132A-L=55 0MM EPDM BIANCO BLU	1.000	PZ
					TB3440A0	TB3132A-L=10 50MM EPDM BIANCO-BLU	1.000	PZ
					VL1019A0	POMPA DETERGENTE VIBRAZIONE	1.000	PZ
					VL1047A1	PORTAGOMM A D6 CODOLO D8	1.000	PZ
					VL1102A1	FILTRO IN LINEA DET. + VNR BARBED 6 MM	1.000	PZ
					VL1128A1	VALVOLA VNR BARBED D6	2.000	PZ
					VL1141A1	RACCORDO DRITTO BB6-BB6	1.000	PZ
					VL1166A0	RACCORDO A L BAM-BB6	4.000	PZ
					VL1174C0	UGELLO CALIBRATO D1.2 MM	1.000	PZ
					VL1186A0	DISTRIBUTOR E LAVAGGIO PLUS 3 VIE UGELLO	1.000	PZ
					VL1190A0	DISTRIBUTOR E INGRESSI LAVAGGIO PLUS	1.000	PZ
					VL1214A0	VALVOLA VNR BB6-BAIONET TA	1.000	PZ

COMPONENT			SPARE PART																																																											
Code	Description	Image	Code	Description	Kit components																																																									
VL1019A	POMPA DETERGENTE VIBRAZIONE		KVL1208A	US PLUS 2 ROTOR ARMS WASHING SYSTEM KIT	<table border="1"> <thead> <tr> <th>Code</th> <th>Description</th> <th>Qty</th> <th>UOM</th> </tr> </thead> <tbody> <tr> <td>VL1398A0</td> <td>PRESSOSTAT O.N.O. 1/4 M CI</td> <td>1.000</td> <td>PZ</td> </tr> <tr> <td>VM1605A0</td> <td>CLIP TWIST LOCK DIAM. 10,2-12,7 MM</td> <td>3.000</td> <td>PZ</td> </tr> <tr> <td>VM2172A0</td> <td>CLIP BLOCCAGGIO POMPA CON CIRCUITO</td> <td>5.000</td> <td>PZ</td> </tr> </tbody> </table>	Code	Description	Qty	UOM	VL1398A0	PRESSOSTAT O.N.O. 1/4 M CI	1.000	PZ	VM1605A0	CLIP TWIST LOCK DIAM. 10,2-12,7 MM	3.000	PZ	VM2172A0	CLIP BLOCCAGGIO POMPA CON CIRCUITO	5.000	PZ																																									
			Code	Description	Qty	UOM																																																								
VL1398A0	PRESSOSTAT O.N.O. 1/4 M CI	1.000	PZ																																																											
VM1605A0	CLIP TWIST LOCK DIAM. 10,2-12,7 MM	3.000	PZ																																																											
VM2172A0	CLIP BLOCCAGGIO POMPA CON CIRCUITO	5.000	PZ																																																											
KVL1207A	US PLUS 1 ROTOR ARM WASHING SYSTEM KIT	<table border="1"> <thead> <tr> <th>Code</th> <th>Description</th> <th>Qty</th> <th>UOM</th> </tr> </thead> <tbody> <tr> <td>0H2354A2</td> <td>LAMIERA IMPIANTO LAVAGGIO PLUS XEVC-XEVL</td> <td>1.000</td> <td>PZ</td> </tr> <tr> <td>EL1346A0</td> <td>CLIP BLOCCA PINZETTA RACCORDI D10 TIERRE</td> <td>2.000</td> <td>PZ</td> </tr> <tr> <td>EL1450A0</td> <td>ELETTROVALV OLA H2O AUTOPULENT E BAF USA</td> <td>3.000</td> <td>PZ</td> </tr> <tr> <td>GN1526A0</td> <td>O-RING D.INT6,9 SP1.8</td> <td>7.000</td> <td>PZ</td> </tr> <tr> <td>RC1018A0</td> <td>FASCETTA ELASTICA D12 ZINCATA</td> <td>1.000</td> <td>PZ</td> </tr> <tr> <td>RC1019A0</td> <td>FASCETTA ELASTICA D10 ZINCATA</td> <td>12.000</td> <td>PZ</td> </tr> <tr> <td>RC1130A0</td> <td>FASCETTA 130X2,6</td> <td>1.000</td> <td>PZ</td> </tr> <tr> <td>RC1131A0</td> <td>FASCETTA 200X2,6 BIANC</td> <td>2.000</td> <td>PZ</td> </tr> <tr> <td>RC1242A0</td> <td>TERMINALE CHIUSO D10</td> <td>2.000</td> <td>PZ</td> </tr> <tr> <td>RC1356A0</td> <td>RACCORDO DRITTO FIL. FEMM 8X1/4 BSP</td> <td>1.000</td> <td>PZ</td> </tr> <tr> <td>RC1414A1</td> <td>FASCETTA STRINGITUBO A SCATTO D11,5-12,5</td> <td>4.000</td> <td>PZ</td> </tr> <tr> <td>TB2821A0</td> <td>TB2820A-L=40 MM EPDM NER</td> <td>4.000</td> <td>PZ</td> </tr> <tr> <td>TB3004A0</td> <td>TB2820A-L=57 0MM EPDM NERO</td> <td>1.000</td> <td>PZ</td> </tr> <tr> <td>TB3005B0</td> <td>TB3132A-L=55 0MM EPDM BIANCO BLU</td> <td>2.000</td> <td>PZ</td> </tr> </tbody> </table>	Code	Description	Qty	UOM	0H2354A2	LAMIERA IMPIANTO LAVAGGIO PLUS XEVC-XEVL	1.000	PZ	EL1346A0	CLIP BLOCCA PINZETTA RACCORDI D10 TIERRE	2.000	PZ	EL1450A0	ELETTROVALV OLA H2O AUTOPULENT E BAF USA	3.000	PZ	GN1526A0	O-RING D.INT6,9 SP1.8	7.000	PZ	RC1018A0	FASCETTA ELASTICA D12 ZINCATA	1.000	PZ	RC1019A0	FASCETTA ELASTICA D10 ZINCATA	12.000	PZ	RC1130A0	FASCETTA 130X2,6	1.000	PZ	RC1131A0	FASCETTA 200X2,6 BIANC	2.000	PZ	RC1242A0	TERMINALE CHIUSO D10	2.000	PZ	RC1356A0	RACCORDO DRITTO FIL. FEMM 8X1/4 BSP	1.000	PZ	RC1414A1	FASCETTA STRINGITUBO A SCATTO D11,5-12,5	4.000	PZ	TB2821A0	TB2820A-L=40 MM EPDM NER	4.000	PZ	TB3004A0	TB2820A-L=57 0MM EPDM NERO	1.000	PZ	TB3005B0	TB3132A-L=55 0MM EPDM BIANCO BLU	2.000	PZ
Code	Description	Qty	UOM																																																											
0H2354A2	LAMIERA IMPIANTO LAVAGGIO PLUS XEVC-XEVL	1.000	PZ																																																											
EL1346A0	CLIP BLOCCA PINZETTA RACCORDI D10 TIERRE	2.000	PZ																																																											
EL1450A0	ELETTROVALV OLA H2O AUTOPULENT E BAF USA	3.000	PZ																																																											
GN1526A0	O-RING D.INT6,9 SP1.8	7.000	PZ																																																											
RC1018A0	FASCETTA ELASTICA D12 ZINCATA	1.000	PZ																																																											
RC1019A0	FASCETTA ELASTICA D10 ZINCATA	12.000	PZ																																																											
RC1130A0	FASCETTA 130X2,6	1.000	PZ																																																											
RC1131A0	FASCETTA 200X2,6 BIANC	2.000	PZ																																																											
RC1242A0	TERMINALE CHIUSO D10	2.000	PZ																																																											
RC1356A0	RACCORDO DRITTO FIL. FEMM 8X1/4 BSP	1.000	PZ																																																											
RC1414A1	FASCETTA STRINGITUBO A SCATTO D11,5-12,5	4.000	PZ																																																											
TB2821A0	TB2820A-L=40 MM EPDM NER	4.000	PZ																																																											
TB3004A0	TB2820A-L=57 0MM EPDM NERO	1.000	PZ																																																											
TB3005B0	TB3132A-L=55 0MM EPDM BIANCO BLU	2.000	PZ																																																											

COMPONENT			SPARE PART																																																																														
Code	Description	Image	Code	Description	Kit components																																																																												
VL1019A	POMPA DETERGENTE VIBRAZIONE		KVL1207A	US PLUS 1 ROTOR ARM WASHING SYSTEM KIT	<table border="1"> <thead> <tr> <th>Code</th> <th>Description</th> <th>Qty</th> <th>UOM</th> </tr> </thead> <tbody> <tr> <td>TB3024C0</td> <td>TB3132A-TUB O BLU 6X12 L=55MM</td> <td>1.000</td> <td>PZ</td> </tr> <tr> <td>TB3225B0</td> <td>TB2820A-TUB O EPDM NERO 670MM</td> <td>1.000</td> <td>PZ</td> </tr> <tr> <td>TB3252A0</td> <td>TB3132A-L=23 0MM EPDM BIANCO BLU</td> <td>1.000</td> <td>PZ</td> </tr> <tr> <td>TB3614A0</td> <td>TB2820A-L=96 MM NERO EPD</td> <td>1.000</td> <td>PZ</td> </tr> <tr> <td>VI1220A1</td> <td>VITE AUTOFIL. 4.2X11 TCS+ MARUTEX</td> <td>1.000</td> <td>PZ</td> </tr> <tr> <td>VL1019A0</td> <td>POMPA DETERGENTE VIBRAZIONE</td> <td>1.000</td> <td>PZ</td> </tr> <tr> <td>VL1047A1</td> <td>PORTAGOMM A D6 CODOLO D8</td> <td>1.000</td> <td>PZ</td> </tr> <tr> <td>VL1102A1</td> <td>FILTRO IN LINEA DET. + VNR BARBED 6 MM</td> <td>1.000</td> <td>PZ</td> </tr> <tr> <td>VL1127A1</td> <td>RACCORDO A T BARBED 6</td> <td>1.000</td> <td>PZ</td> </tr> <tr> <td>VL1128A1</td> <td>VALVOLA VNR BARBED D6</td> <td>1.000</td> <td>PZ</td> </tr> <tr> <td>VL1166A0</td> <td>RACCORDO A L BAM-BB6</td> <td>3.000</td> <td>PZ</td> </tr> <tr> <td>VL1174C0</td> <td>UGELLO CALIBRATO D1.2 MM</td> <td>1.000</td> <td>PZ</td> </tr> <tr> <td>VL1185A0</td> <td>DISTRIBUTOR E LAVAGGIO PLUS 2 VIE UGELLO</td> <td>1.000</td> <td>PZ</td> </tr> <tr> <td>VL1190A0</td> <td>DISTRIBUTOR E INGRESSI LAVAGGIO PLUS</td> <td>1.000</td> <td>PZ</td> </tr> <tr> <td>VL1214A0</td> <td>VALVOLA VNR BB6-BAIONET TA</td> <td>1.000</td> <td>PZ</td> </tr> <tr> <td>VL1398A0</td> <td>PRESSOSTAT O.N.O. 1/4 M CI</td> <td>1.000</td> <td>PZ</td> </tr> <tr> <td>VM1605A0</td> <td>CLIP TWIST LOCK DIAM. 10.2-12.7 MM</td> <td>3.000</td> <td>PZ</td> </tr> <tr> <td>VM2172A0</td> <td>CLIP BLOCCAGGIO POMPA CON CIRCUITO</td> <td>4.000</td> <td>PZ</td> </tr> </tbody> </table>	Code	Description	Qty	UOM	TB3024C0	TB3132A-TUB O BLU 6X12 L=55MM	1.000	PZ	TB3225B0	TB2820A-TUB O EPDM NERO 670MM	1.000	PZ	TB3252A0	TB3132A-L=23 0MM EPDM BIANCO BLU	1.000	PZ	TB3614A0	TB2820A-L=96 MM NERO EPD	1.000	PZ	VI1220A1	VITE AUTOFIL. 4.2X11 TCS+ MARUTEX	1.000	PZ	VL1019A0	POMPA DETERGENTE VIBRAZIONE	1.000	PZ	VL1047A1	PORTAGOMM A D6 CODOLO D8	1.000	PZ	VL1102A1	FILTRO IN LINEA DET. + VNR BARBED 6 MM	1.000	PZ	VL1127A1	RACCORDO A T BARBED 6	1.000	PZ	VL1128A1	VALVOLA VNR BARBED D6	1.000	PZ	VL1166A0	RACCORDO A L BAM-BB6	3.000	PZ	VL1174C0	UGELLO CALIBRATO D1.2 MM	1.000	PZ	VL1185A0	DISTRIBUTOR E LAVAGGIO PLUS 2 VIE UGELLO	1.000	PZ	VL1190A0	DISTRIBUTOR E INGRESSI LAVAGGIO PLUS	1.000	PZ	VL1214A0	VALVOLA VNR BB6-BAIONET TA	1.000	PZ	VL1398A0	PRESSOSTAT O.N.O. 1/4 M CI	1.000	PZ	VM1605A0	CLIP TWIST LOCK DIAM. 10.2-12.7 MM	3.000	PZ	VM2172A0	CLIP BLOCCAGGIO POMPA CON CIRCUITO	4.000	PZ
Code	Description	Qty	UOM																																																																														
TB3024C0	TB3132A-TUB O BLU 6X12 L=55MM	1.000	PZ																																																																														
TB3225B0	TB2820A-TUB O EPDM NERO 670MM	1.000	PZ																																																																														
TB3252A0	TB3132A-L=23 0MM EPDM BIANCO BLU	1.000	PZ																																																																														
TB3614A0	TB2820A-L=96 MM NERO EPD	1.000	PZ																																																																														
VI1220A1	VITE AUTOFIL. 4.2X11 TCS+ MARUTEX	1.000	PZ																																																																														
VL1019A0	POMPA DETERGENTE VIBRAZIONE	1.000	PZ																																																																														
VL1047A1	PORTAGOMM A D6 CODOLO D8	1.000	PZ																																																																														
VL1102A1	FILTRO IN LINEA DET. + VNR BARBED 6 MM	1.000	PZ																																																																														
VL1127A1	RACCORDO A T BARBED 6	1.000	PZ																																																																														
VL1128A1	VALVOLA VNR BARBED D6	1.000	PZ																																																																														
VL1166A0	RACCORDO A L BAM-BB6	3.000	PZ																																																																														
VL1174C0	UGELLO CALIBRATO D1.2 MM	1.000	PZ																																																																														
VL1185A0	DISTRIBUTOR E LAVAGGIO PLUS 2 VIE UGELLO	1.000	PZ																																																																														
VL1190A0	DISTRIBUTOR E INGRESSI LAVAGGIO PLUS	1.000	PZ																																																																														
VL1214A0	VALVOLA VNR BB6-BAIONET TA	1.000	PZ																																																																														
VL1398A0	PRESSOSTAT O.N.O. 1/4 M CI	1.000	PZ																																																																														
VM1605A0	CLIP TWIST LOCK DIAM. 10.2-12.7 MM	3.000	PZ																																																																														
VM2172A0	CLIP BLOCCAGGIO POMPA CON CIRCUITO	4.000	PZ																																																																														

COMPONENT			SPARE PART																																																																														
Code	Description	Image	Code	Description	Kit components																																																																												
VL1019A	POMPA DETERGENTE VIBRAZIONE		KVL1198A	MM EU HOOD CLEANING SYSTEM KIT	<table border="1"> <thead> <tr> <th>Code</th> <th>Description</th> <th>Qty</th> <th>UOM</th> </tr> </thead> <tbody> <tr> <td>0H2213A1</td> <td>LAMIERA IMPIANTO IDRICO CAPPA</td> <td>1.000</td> <td>PZ</td> </tr> <tr> <td>EL1346A0</td> <td>CLIP BLOCCA PINZETTA RACCORDI D10 TIERRE</td> <td>2.000</td> <td>PZ</td> </tr> <tr> <td>EL1440A0</td> <td>ELETTROVALV OLA H2O AUTOPULENT E BAF EU</td> <td>2.000</td> <td>PZ</td> </tr> <tr> <td>GN1526A0</td> <td>O-RING D.INT6.9 SP1.8</td> <td>5.000</td> <td>PZ</td> </tr> <tr> <td>RC1018A0</td> <td>FASCETTA ELASTICA D12 ZINCATA</td> <td>1.000</td> <td>PZ</td> </tr> <tr> <td>RC1019A0</td> <td>FASCETTA ELASTICA D10 ZINCATA</td> <td>14.000</td> <td>PZ</td> </tr> <tr> <td>RC1131A0</td> <td>FASCETTA 200X2.6 BIANC</td> <td>1.000</td> <td>PZ</td> </tr> <tr> <td>RC1242A0</td> <td>TERMINALE CHIUSO D10</td> <td>2.000</td> <td>PZ</td> </tr> <tr> <td>RC1414A1</td> <td>FASCETTA STRINGITUBO A SCATTO D11.5-12.5</td> <td>5.000</td> <td>PZ</td> </tr> <tr> <td>TB2821A0</td> <td>TB2820A-L=40 MM EPDM NER</td> <td>4.000</td> <td>PZ</td> </tr> <tr> <td>TB2994A0</td> <td>TB2820A-TUB O EPDM NERO 1000MM</td> <td>2.000</td> <td>PZ</td> </tr> <tr> <td>TB3252A0</td> <td>TB3132A-L=23 0MM EPDM BIANCO BLU</td> <td>2.000</td> <td>PZ</td> </tr> <tr> <td>TB3614A0</td> <td>TB2820A-L=96 MM NERO EPD</td> <td>1.000</td> <td>PZ</td> </tr> <tr> <td>VH1220A1</td> <td>VITE AUTOFIL 4.2X11 TCS+ MARUTEX</td> <td>3.000</td> <td>PZ</td> </tr> <tr> <td>VI2070A0</td> <td>VITE AUTOFIL 40X8 TCB+ SHEETTRACS</td> <td>2.000</td> <td>PZ</td> </tr> <tr> <td>VL1019A0</td> <td>POMPA DETERGENTE VIBRAZIONE</td> <td>1.000</td> <td>PZ</td> </tr> <tr> <td>VL1047A1</td> <td>PORTAGOMM A D6 CODOLO D8</td> <td>2.000</td> <td>PZ</td> </tr> <tr> <td>VL1054B0</td> <td>DISTRIBUTOR E INGRESSI LAVAGGIO ON</td> <td>1.000</td> <td>PZ</td> </tr> </tbody> </table>	Code	Description	Qty	UOM	0H2213A1	LAMIERA IMPIANTO IDRICO CAPPA	1.000	PZ	EL1346A0	CLIP BLOCCA PINZETTA RACCORDI D10 TIERRE	2.000	PZ	EL1440A0	ELETTROVALV OLA H2O AUTOPULENT E BAF EU	2.000	PZ	GN1526A0	O-RING D.INT6.9 SP1.8	5.000	PZ	RC1018A0	FASCETTA ELASTICA D12 ZINCATA	1.000	PZ	RC1019A0	FASCETTA ELASTICA D10 ZINCATA	14.000	PZ	RC1131A0	FASCETTA 200X2.6 BIANC	1.000	PZ	RC1242A0	TERMINALE CHIUSO D10	2.000	PZ	RC1414A1	FASCETTA STRINGITUBO A SCATTO D11.5-12.5	5.000	PZ	TB2821A0	TB2820A-L=40 MM EPDM NER	4.000	PZ	TB2994A0	TB2820A-TUB O EPDM NERO 1000MM	2.000	PZ	TB3252A0	TB3132A-L=23 0MM EPDM BIANCO BLU	2.000	PZ	TB3614A0	TB2820A-L=96 MM NERO EPD	1.000	PZ	VH1220A1	VITE AUTOFIL 4.2X11 TCS+ MARUTEX	3.000	PZ	VI2070A0	VITE AUTOFIL 40X8 TCB+ SHEETTRACS	2.000	PZ	VL1019A0	POMPA DETERGENTE VIBRAZIONE	1.000	PZ	VL1047A1	PORTAGOMM A D6 CODOLO D8	2.000	PZ	VL1054B0	DISTRIBUTOR E INGRESSI LAVAGGIO ON	1.000	PZ
Code	Description	Qty	UOM																																																																														
0H2213A1	LAMIERA IMPIANTO IDRICO CAPPA	1.000	PZ																																																																														
EL1346A0	CLIP BLOCCA PINZETTA RACCORDI D10 TIERRE	2.000	PZ																																																																														
EL1440A0	ELETTROVALV OLA H2O AUTOPULENT E BAF EU	2.000	PZ																																																																														
GN1526A0	O-RING D.INT6.9 SP1.8	5.000	PZ																																																																														
RC1018A0	FASCETTA ELASTICA D12 ZINCATA	1.000	PZ																																																																														
RC1019A0	FASCETTA ELASTICA D10 ZINCATA	14.000	PZ																																																																														
RC1131A0	FASCETTA 200X2.6 BIANC	1.000	PZ																																																																														
RC1242A0	TERMINALE CHIUSO D10	2.000	PZ																																																																														
RC1414A1	FASCETTA STRINGITUBO A SCATTO D11.5-12.5	5.000	PZ																																																																														
TB2821A0	TB2820A-L=40 MM EPDM NER	4.000	PZ																																																																														
TB2994A0	TB2820A-TUB O EPDM NERO 1000MM	2.000	PZ																																																																														
TB3252A0	TB3132A-L=23 0MM EPDM BIANCO BLU	2.000	PZ																																																																														
TB3614A0	TB2820A-L=96 MM NERO EPD	1.000	PZ																																																																														
VH1220A1	VITE AUTOFIL 4.2X11 TCS+ MARUTEX	3.000	PZ																																																																														
VI2070A0	VITE AUTOFIL 40X8 TCB+ SHEETTRACS	2.000	PZ																																																																														
VL1019A0	POMPA DETERGENTE VIBRAZIONE	1.000	PZ																																																																														
VL1047A1	PORTAGOMM A D6 CODOLO D8	2.000	PZ																																																																														
VL1054B0	DISTRIBUTOR E INGRESSI LAVAGGIO ON	1.000	PZ																																																																														

COMPONENT			SPARE PART																																														
Code	Description	Image	Code	Description	Kit components																																												
VL1019A	POMPA DETERGENTE VIBRAZIONE		KVL1198A	MM EU HOOD CLEANING SYSTEM KIT	<table border="1"> <thead> <tr> <th>Code</th> <th>Description</th> <th>Qty</th> <th>UOM</th> </tr> </thead> <tbody> <tr> <td>VL1102A1</td> <td>FILTRO IN LINEA DET. + VNR BARBED 6 MM</td> <td>1.000</td> <td>PZ</td> </tr> <tr> <td>VL1127A1</td> <td>RACCORDO A T BARBED 6</td> <td>1.000</td> <td>PZ</td> </tr> <tr> <td>VL1128A1</td> <td>VALVOLA VNR BARBED D6</td> <td>1.000</td> <td>PZ</td> </tr> <tr> <td>VL1165A0</td> <td>RACCORDO DRITTO BAM-BB6</td> <td>1.000</td> <td>PZ</td> </tr> <tr> <td>VL1166A0</td> <td>RACCORDO A L BAM-BB6</td> <td>2.000</td> <td>PZ</td> </tr> <tr> <td>VL1174C0</td> <td>UGELLO CALIBRATO D1.2 MM</td> <td>1.000</td> <td>PZ</td> </tr> <tr> <td>VL1191A0</td> <td>DISTRIBUTOR E USCITA LAVAGGIO ON</td> <td>1.000</td> <td>PZ</td> </tr> <tr> <td>VL1214A0</td> <td>VALVOLA VNR BB6-BAIONET TA</td> <td>1.000</td> <td>PZ</td> </tr> <tr> <td>VM1605A0</td> <td>CLIP TWIST LOCK DIAM. 10,2-12,7 MM</td> <td>2.000</td> <td>PZ</td> </tr> <tr> <td>VM2172A0</td> <td>CLIP BLOCCAGGIO POMPA CON CIRCUITO</td> <td>3.000</td> <td>PZ</td> </tr> </tbody> </table>	Code	Description	Qty	UOM	VL1102A1	FILTRO IN LINEA DET. + VNR BARBED 6 MM	1.000	PZ	VL1127A1	RACCORDO A T BARBED 6	1.000	PZ	VL1128A1	VALVOLA VNR BARBED D6	1.000	PZ	VL1165A0	RACCORDO DRITTO BAM-BB6	1.000	PZ	VL1166A0	RACCORDO A L BAM-BB6	2.000	PZ	VL1174C0	UGELLO CALIBRATO D1.2 MM	1.000	PZ	VL1191A0	DISTRIBUTOR E USCITA LAVAGGIO ON	1.000	PZ	VL1214A0	VALVOLA VNR BB6-BAIONET TA	1.000	PZ	VM1605A0	CLIP TWIST LOCK DIAM. 10,2-12,7 MM	2.000	PZ	VM2172A0	CLIP BLOCCAGGIO POMPA CON CIRCUITO	3.000	PZ
			Code	Description	Qty	UOM																																											
VL1102A1	FILTRO IN LINEA DET. + VNR BARBED 6 MM	1.000	PZ																																														
VL1127A1	RACCORDO A T BARBED 6	1.000	PZ																																														
VL1128A1	VALVOLA VNR BARBED D6	1.000	PZ																																														
VL1165A0	RACCORDO DRITTO BAM-BB6	1.000	PZ																																														
VL1166A0	RACCORDO A L BAM-BB6	2.000	PZ																																														
VL1174C0	UGELLO CALIBRATO D1.2 MM	1.000	PZ																																														
VL1191A0	DISTRIBUTOR E USCITA LAVAGGIO ON	1.000	PZ																																														
VL1214A0	VALVOLA VNR BB6-BAIONET TA	1.000	PZ																																														
VM1605A0	CLIP TWIST LOCK DIAM. 10,2-12,7 MM	2.000	PZ																																														
VM2172A0	CLIP BLOCCAGGIO POMPA CON CIRCUITO	3.000	PZ																																														
KVL1187A	3 ROTOR ARMS PLUS EU CLEANING SYSTEM KIT	<table border="1"> <thead> <tr> <th>Code</th> <th>Description</th> <th>Qty</th> <th>UOM</th> </tr> </thead> <tbody> <tr> <td>0H2354A2</td> <td>LAMIERA IMPIANTO LAVAGGIO PLUS XEVC-XEVL</td> <td>1.000</td> <td>PZ</td> </tr> <tr> <td>EL1346A0</td> <td>CLIP BLOCCA PINZETTA RACCORDI D10 TIERRE</td> <td>2.000</td> <td>PZ</td> </tr> <tr> <td>EL1440A0</td> <td>ELETTROVALV OLA H2O AUTOPULENT E BAF EU</td> <td>4.000</td> <td>PZ</td> </tr> <tr> <td>GN1526A0</td> <td>O-RING D.INT6,9 SP1,8</td> <td>9.000</td> <td>PZ</td> </tr> <tr> <td>RC1018A0</td> <td>FASCETTA ELASTICA D12 ZINCATA</td> <td>11.000</td> <td>PZ</td> </tr> <tr> <td>RC1019A0</td> <td>FASCETTA ELASTICA D10 ZINCATA</td> <td>14.000</td> <td>PZ</td> </tr> <tr> <td>RC1130A0</td> <td>FASCETTA 130X2,6</td> <td>1.000</td> <td>PZ</td> </tr> </tbody> </table>	Code	Description	Qty	UOM	0H2354A2	LAMIERA IMPIANTO LAVAGGIO PLUS XEVC-XEVL	1.000	PZ	EL1346A0	CLIP BLOCCA PINZETTA RACCORDI D10 TIERRE	2.000	PZ	EL1440A0	ELETTROVALV OLA H2O AUTOPULENT E BAF EU	4.000	PZ	GN1526A0	O-RING D.INT6,9 SP1,8	9.000	PZ	RC1018A0	FASCETTA ELASTICA D12 ZINCATA	11.000	PZ	RC1019A0	FASCETTA ELASTICA D10 ZINCATA	14.000	PZ	RC1130A0	FASCETTA 130X2,6	1.000	PZ															
Code	Description	Qty	UOM																																														
0H2354A2	LAMIERA IMPIANTO LAVAGGIO PLUS XEVC-XEVL	1.000	PZ																																														
EL1346A0	CLIP BLOCCA PINZETTA RACCORDI D10 TIERRE	2.000	PZ																																														
EL1440A0	ELETTROVALV OLA H2O AUTOPULENT E BAF EU	4.000	PZ																																														
GN1526A0	O-RING D.INT6,9 SP1,8	9.000	PZ																																														
RC1018A0	FASCETTA ELASTICA D12 ZINCATA	11.000	PZ																																														
RC1019A0	FASCETTA ELASTICA D10 ZINCATA	14.000	PZ																																														
RC1130A0	FASCETTA 130X2,6	1.000	PZ																																														

COMPONENT			SPARE PART					
Code	Description	Image	Code	Description	Kit components			
VL1019A	POMPA DETERGENTE VIBRAZIONE		KVL1187A	3 ROTOR ARMS PLUS EU CLEANING SYSTEM KIT	Code	Description	Qty	UOM
					RC1131A0	FASCETTA 200X2,6 BIANCO	3.000	PZ
					RC1242A0	TERMINALE CHIUSO D10	2.000	PZ
					RC1356A0	RACCORDO DRITTO FIL. FEMM 8X1/4 BSP	1.000	PZ
					RC1414A1	FASCETTA STRINGITUBO A SCATTO D11,5-12,5	1.000	PZ
					TB2652A0	TB3132A-L750 MM BIANCO BLU EPDM	1.000	PZ
					TB2677A0	TB2820A-TUB O TANICA DET-FDET L1300MM	1.000	PZ
					TB2821A0	TB2820A-L=40 MM EPDM NER	4.000	PZ
					TB3004A0	TB2820A-L=57 0MM EPDM NERO	2.000	PZ
					TB3024C0	TB3132A-TUB O BLU 6X12 L=55MM	3.000	PZ
					TB3226A0	TB2820A-L110 MM COLLEGAMEN TO TANICA-LA	1.000	PZ
					TB3440A0	TB3132A-L=10 50MM EPDM BIANCO-BLU	1.000	PZ
					TB3614A0	TB2820A-L=96 MM NERO EPD	1.000	PZ
					VI1220A1	VITE AUTOFIL. 4.2X11 TCS+ MARUTEX	1.000	PZ
					VL1019A0	POMPA DETERGENTE VIBRAZIONE	1.000	PZ
					VL1047A1	PORTAGOMM A D6 CODOLO D8	1.000	PZ
					VL1102A1	FILTRO IN LINEA DET. + VNR BARBED 6 MM	1.000	PZ
					VL1127A1	RACCORDO A T BARBED 6	2.000	PZ
					VL1128A1	VALVOLA VNR BARBED D6	2.000	PZ
					VL1166A0	RACCORDO A L BAM-BB6	4.000	PZ

COMPONENT			SPARE PART																																						
Code	Description	Image	Code	Description	Kit components																																				
VL1019A	POMPA DETERGENTE VIBRAZIONE		KVL1187A	3 ROTOR ARMS PLUS EU CLEANING SYSTEM KIT	<table border="1"> <thead> <tr> <th>Code</th> <th>Description</th> <th>Qty</th> <th>UOM</th> </tr> </thead> <tbody> <tr> <td>VL1167A2</td> <td>FLOW RESTRICTOR 3 GIRANTI GN21 B-B</td> <td>1.000</td> <td>PZ</td> </tr> <tr> <td>VL1174C0</td> <td>UGELLO CALIBRATO D1.2 MM</td> <td>1.000</td> <td>PZ</td> </tr> <tr> <td>VL1186A0</td> <td>DISTRIBUTOR E LAVAGGIO PLUS 3 VIE UGELLO</td> <td>1.000</td> <td>PZ</td> </tr> <tr> <td>VL1190A0</td> <td>DISTRIBUTOR E INGRESSI LAVAGGIO PLUS</td> <td>1.000</td> <td>PZ</td> </tr> <tr> <td>VL1214A0</td> <td>VALVOLA VNR BB6-BAIONET TA</td> <td>1.000</td> <td>PZ</td> </tr> <tr> <td>VL1398A0</td> <td>PRESSOSTAT O.N.O. 1/4 M CI</td> <td>1.000</td> <td>PZ</td> </tr> <tr> <td>VM1605A0</td> <td>CLIP TWIST LOCK DIAM. 10,2-12,7 MM</td> <td>3.000</td> <td>PZ</td> </tr> <tr> <td>VM2172A0</td> <td>CLIP BLOCCAGGIO POMPA CON CIRCUITO</td> <td>5.000</td> <td>PZ</td> </tr> </tbody> </table>	Code	Description	Qty	UOM	VL1167A2	FLOW RESTRICTOR 3 GIRANTI GN21 B-B	1.000	PZ	VL1174C0	UGELLO CALIBRATO D1.2 MM	1.000	PZ	VL1186A0	DISTRIBUTOR E LAVAGGIO PLUS 3 VIE UGELLO	1.000	PZ	VL1190A0	DISTRIBUTOR E INGRESSI LAVAGGIO PLUS	1.000	PZ	VL1214A0	VALVOLA VNR BB6-BAIONET TA	1.000	PZ	VL1398A0	PRESSOSTAT O.N.O. 1/4 M CI	1.000	PZ	VM1605A0	CLIP TWIST LOCK DIAM. 10,2-12,7 MM	3.000	PZ	VM2172A0	CLIP BLOCCAGGIO POMPA CON CIRCUITO	5.000	PZ
			Code	Description	Qty	UOM																																			
VL1167A2	FLOW RESTRICTOR 3 GIRANTI GN21 B-B	1.000	PZ																																						
VL1174C0	UGELLO CALIBRATO D1.2 MM	1.000	PZ																																						
VL1186A0	DISTRIBUTOR E LAVAGGIO PLUS 3 VIE UGELLO	1.000	PZ																																						
VL1190A0	DISTRIBUTOR E INGRESSI LAVAGGIO PLUS	1.000	PZ																																						
VL1214A0	VALVOLA VNR BB6-BAIONET TA	1.000	PZ																																						
VL1398A0	PRESSOSTAT O.N.O. 1/4 M CI	1.000	PZ																																						
VM1605A0	CLIP TWIST LOCK DIAM. 10,2-12,7 MM	3.000	PZ																																						
VM2172A0	CLIP BLOCCAGGIO POMPA CON CIRCUITO	5.000	PZ																																						
KVL1184A	2 ROTOR ARMS PLUS EU CLEANING SYSTEM KIT	<table border="1"> <thead> <tr> <th>Code</th> <th>Description</th> <th>Qty</th> <th>UOM</th> </tr> </thead> <tbody> <tr> <td>0H2354A2</td> <td>LAMIERA IMPIANTO LAVAGGIO PLUS XEVC-XEVL</td> <td>1.000</td> <td>PZ</td> </tr> <tr> <td>EL1346A0</td> <td>CLIP BLOCCA PINZETTA RACCORDI D10 TIERRE</td> <td>2.000</td> <td>PZ</td> </tr> <tr> <td>EL1440A0</td> <td>ELETTROVALV OLA H2O AUTOPULENT E BAF EU</td> <td>4.000</td> <td>PZ</td> </tr> <tr> <td>GN1526A0</td> <td>O-RING D.INT6.9 SP1.8</td> <td>9.000</td> <td>PZ</td> </tr> <tr> <td>RC1018A0</td> <td>FASCETTA ELASTICA D12 ZINCATA</td> <td>2.000</td> <td>PZ</td> </tr> <tr> <td>RC1019A0</td> <td>FASCETTA ELASTICA D10 ZINCATA</td> <td>13.000</td> <td>PZ</td> </tr> <tr> <td>RC1130A0</td> <td>FASCETTA 130X2,6</td> <td>1.000</td> <td>PZ</td> </tr> <tr> <td>RC1131A0</td> <td>FASCETTA 200X2,6 BIANC</td> <td>3.000</td> <td>PZ</td> </tr> </tbody> </table>	Code	Description	Qty	UOM	0H2354A2	LAMIERA IMPIANTO LAVAGGIO PLUS XEVC-XEVL	1.000	PZ	EL1346A0	CLIP BLOCCA PINZETTA RACCORDI D10 TIERRE	2.000	PZ	EL1440A0	ELETTROVALV OLA H2O AUTOPULENT E BAF EU	4.000	PZ	GN1526A0	O-RING D.INT6.9 SP1.8	9.000	PZ	RC1018A0	FASCETTA ELASTICA D12 ZINCATA	2.000	PZ	RC1019A0	FASCETTA ELASTICA D10 ZINCATA	13.000	PZ	RC1130A0	FASCETTA 130X2,6	1.000	PZ	RC1131A0	FASCETTA 200X2,6 BIANC	3.000	PZ			
Code	Description	Qty	UOM																																						
0H2354A2	LAMIERA IMPIANTO LAVAGGIO PLUS XEVC-XEVL	1.000	PZ																																						
EL1346A0	CLIP BLOCCA PINZETTA RACCORDI D10 TIERRE	2.000	PZ																																						
EL1440A0	ELETTROVALV OLA H2O AUTOPULENT E BAF EU	4.000	PZ																																						
GN1526A0	O-RING D.INT6.9 SP1.8	9.000	PZ																																						
RC1018A0	FASCETTA ELASTICA D12 ZINCATA	2.000	PZ																																						
RC1019A0	FASCETTA ELASTICA D10 ZINCATA	13.000	PZ																																						
RC1130A0	FASCETTA 130X2,6	1.000	PZ																																						
RC1131A0	FASCETTA 200X2,6 BIANC	3.000	PZ																																						

COMPONENT			SPARE PART					
Code	Description	Image	Code	Description	Kit components			
VL1019A	POMPA DETERGENTE VIBRAZIONE		KVL1184A	2 ROTOR ARMS PLUS EU CLEANING SYSTEM KIT	Code	Description	Qty	UOM
					RC1242A0	TERMINALE CHIUSO D10	2.000	PZ
					RC1356A0	RACCORDO DRITTO FIL. FEMM 8X1/4 BSP	1.000	PZ
					RC1414A1	FASCETTA STRINGITUBO A SCATTO D11.5-12.5	1.000	PZ
					TB2821A0	TB2820A-L=40 MM EPDM NER	4.000	PZ
					TB2994A0	TB2820A-TUB O EPDM NERO 1000MM	1.000	PZ
					TB3004A0	TB2820A-L=57 0MM EPDM NERO	2.000	PZ
					TB3005B0	TB3132A-L=55 0MM EPDM BIANCO BLU	1.000	PZ
					TB3440A0	TB3132A-L=10 50MM EPDM BIANCO-BLU	1.000	PZ
					TB3614A0	TB2820A-L=96 MM NERO EPD	1.000	PZ
					VI1220A1	VITE AUTOFIL. 4.2X11 TCS+ MARUTEX	1.000	PZ
					VL1019A0	POMPA DETERGENTE VIBRAZIONE	1.000	PZ
					VL1047A1	PORTAGOMM A D6 CODOLO D8	1.000	PZ
					VL1102A1	FILTRO IN LINEA DET. + VNR BARBED 6 MM	1.000	PZ
					VL1128A1	VALVOLA VNR BARBED D6	1.000	PZ
					VL1166A0	RACCORDO A L BAM-BB6	4.000	PZ
					VL1174C0	UGELLO CALIBRATO D1.2 MM	1.000	PZ
					VL1186A0	DISTRIBUTOR E LAVAGGIO PLUS 3 VIE UGELLO	1.000	PZ
					VL1190A0	DISTRIBUTOR E INGRESSI LAVAGGIO PLUS	1.000	PZ

COMPONENT			SPARE PART																																																							
Code	Description	Image	Code	Description	Kit components																																																					
VL1019A	POMPA DETERGENTE VIBRAZIONE		KVL1184A	2 ROTOR ARMS PLUS EU CLEANING SYSTEM KIT	<table border="1"> <thead> <tr> <th>Code</th> <th>Description</th> <th>Qty</th> <th>UOM</th> </tr> </thead> <tbody> <tr> <td>VL1214A0</td> <td>VALVOLA VNR BB6-BAIONET TA</td> <td>1.000</td> <td>PZ</td> </tr> <tr> <td>VL1398A0</td> <td>PRESSOSTAT O.N.O. 1/4 M CI</td> <td>1.000</td> <td>PZ</td> </tr> <tr> <td>VM1605A0</td> <td>CLIP TWIST LOCK DIAM. 10,2-12,7 MM</td> <td>3.000</td> <td>PZ</td> </tr> <tr> <td>VM2172A0</td> <td>CLIP BLOCCAGGIO POMPA CON CIRCUITO</td> <td>5.000</td> <td>PZ</td> </tr> </tbody> </table>	Code	Description	Qty	UOM	VL1214A0	VALVOLA VNR BB6-BAIONET TA	1.000	PZ	VL1398A0	PRESSOSTAT O.N.O. 1/4 M CI	1.000	PZ	VM1605A0	CLIP TWIST LOCK DIAM. 10,2-12,7 MM	3.000	PZ	VM2172A0	CLIP BLOCCAGGIO POMPA CON CIRCUITO	5.000	PZ																																	
			Code	Description	Qty	UOM																																																				
VL1214A0	VALVOLA VNR BB6-BAIONET TA	1.000	PZ																																																							
VL1398A0	PRESSOSTAT O.N.O. 1/4 M CI	1.000	PZ																																																							
VM1605A0	CLIP TWIST LOCK DIAM. 10,2-12,7 MM	3.000	PZ																																																							
VM2172A0	CLIP BLOCCAGGIO POMPA CON CIRCUITO	5.000	PZ																																																							
KVL1183A	1 ROTOR ARM PLUS CLEANING SYSTEM KIT	<table border="1"> <thead> <tr> <th>Code</th> <th>Description</th> <th>Qty</th> <th>UOM</th> </tr> </thead> <tbody> <tr> <td>0H2354A2</td> <td>LAMIERA IMPIANTO LAVAGGIO PLUS XEVC-XEVL</td> <td>1.000</td> <td>PZ</td> </tr> <tr> <td>EL1346A0</td> <td>CLIP BLOCCA PINZETTA RACCORDI D10 TIERRE</td> <td>2.000</td> <td>PZ</td> </tr> <tr> <td>EL1440A0</td> <td>ELETTROVALV OLA H2O AUTOPULENT E BAF EU</td> <td>3.000</td> <td>PZ</td> </tr> <tr> <td>GN1526A0</td> <td>O-RING D.INT6.9 SP1.8</td> <td>7.000</td> <td>PZ</td> </tr> <tr> <td>RC1018A0</td> <td>FASCETTA ELASTICA D12 ZINCATA</td> <td>1.000</td> <td>PZ</td> </tr> <tr> <td>RC1019A0</td> <td>FASCETTA ELASTICA D10 ZINCATA</td> <td>12.000</td> <td>PZ</td> </tr> <tr> <td>RC1130A0</td> <td>FASCETTA 130X2,6</td> <td>1.000</td> <td>PZ</td> </tr> <tr> <td>RC1131A0</td> <td>FASCETTA 200X2,6 BIANC</td> <td>2.000</td> <td>PZ</td> </tr> <tr> <td>RC1242A0</td> <td>TERMINALE CHIUSO D10</td> <td>2.000</td> <td>PZ</td> </tr> <tr> <td>RC1356A0</td> <td>RACCORDO DRITTO FIL. FEMM 8X1/4 BSP</td> <td>1.000</td> <td>PZ</td> </tr> <tr> <td>RC1414A1</td> <td>FASCETTA STRINGITUBO A SCATTO D11,5-12,5</td> <td>4.000</td> <td>PZ</td> </tr> <tr> <td>TB2821A0</td> <td>TB2820A-L=40 MM EPDM NER</td> <td>4.000</td> <td>PZ</td> </tr> <tr> <td>TB3004A0</td> <td>TB2820A-L=57 0MM EPDM NERO</td> <td>1.000</td> <td>PZ</td> </tr> </tbody> </table>	Code	Description	Qty	UOM	0H2354A2	LAMIERA IMPIANTO LAVAGGIO PLUS XEVC-XEVL	1.000	PZ	EL1346A0	CLIP BLOCCA PINZETTA RACCORDI D10 TIERRE	2.000	PZ	EL1440A0	ELETTROVALV OLA H2O AUTOPULENT E BAF EU	3.000	PZ	GN1526A0	O-RING D.INT6.9 SP1.8	7.000	PZ	RC1018A0	FASCETTA ELASTICA D12 ZINCATA	1.000	PZ	RC1019A0	FASCETTA ELASTICA D10 ZINCATA	12.000	PZ	RC1130A0	FASCETTA 130X2,6	1.000	PZ	RC1131A0	FASCETTA 200X2,6 BIANC	2.000	PZ	RC1242A0	TERMINALE CHIUSO D10	2.000	PZ	RC1356A0	RACCORDO DRITTO FIL. FEMM 8X1/4 BSP	1.000	PZ	RC1414A1	FASCETTA STRINGITUBO A SCATTO D11,5-12,5	4.000	PZ	TB2821A0	TB2820A-L=40 MM EPDM NER	4.000	PZ	TB3004A0	TB2820A-L=57 0MM EPDM NERO	1.000	PZ
Code	Description	Qty	UOM																																																							
0H2354A2	LAMIERA IMPIANTO LAVAGGIO PLUS XEVC-XEVL	1.000	PZ																																																							
EL1346A0	CLIP BLOCCA PINZETTA RACCORDI D10 TIERRE	2.000	PZ																																																							
EL1440A0	ELETTROVALV OLA H2O AUTOPULENT E BAF EU	3.000	PZ																																																							
GN1526A0	O-RING D.INT6.9 SP1.8	7.000	PZ																																																							
RC1018A0	FASCETTA ELASTICA D12 ZINCATA	1.000	PZ																																																							
RC1019A0	FASCETTA ELASTICA D10 ZINCATA	12.000	PZ																																																							
RC1130A0	FASCETTA 130X2,6	1.000	PZ																																																							
RC1131A0	FASCETTA 200X2,6 BIANC	2.000	PZ																																																							
RC1242A0	TERMINALE CHIUSO D10	2.000	PZ																																																							
RC1356A0	RACCORDO DRITTO FIL. FEMM 8X1/4 BSP	1.000	PZ																																																							
RC1414A1	FASCETTA STRINGITUBO A SCATTO D11,5-12,5	4.000	PZ																																																							
TB2821A0	TB2820A-L=40 MM EPDM NER	4.000	PZ																																																							
TB3004A0	TB2820A-L=57 0MM EPDM NERO	1.000	PZ																																																							



COMPONENT			SPARE PART																																																																										
Code	Description	Image	Code	Description	Kit components																																																																								
VL1019A	POMPA DETERGENTE VIBRAZIONE		KVL1183A	1 ROTOR ARM PLUS CLEANING SYSTEM KIT	<table border="1"> <thead> <tr> <th>Code</th> <th>Description</th> <th>Qty</th> <th>UOM</th> </tr> </thead> <tbody> <tr> <td>TB3252A0</td> <td>TB3132A-L=23 0MM EPDM BIANCO BLU</td> <td>1.000</td> <td>PZ</td> </tr> <tr> <td>TB3614A0</td> <td>TB2820A-L=96 MM NERO EPD</td> <td>1.000</td> <td>PZ</td> </tr> <tr> <td>TB5360A0</td> <td>TB3132A-TUB O EPDM TELATO BIANCO-BLU 550M</td> <td>1.000</td> <td>PZ</td> </tr> <tr> <td>TB5362A0</td> <td>TB3132A-TUB O EPDM TELATO BIANCO-BLU 230M</td> <td>1.000</td> <td>PZ</td> </tr> <tr> <td>VI1220A1</td> <td>VITE AUTOFIL. 4.2X11 TCS+ MARUTEX</td> <td>1.000</td> <td>PZ</td> </tr> <tr> <td>VL1019A0</td> <td>POMPA DETERGENTE VIBRAZIONE</td> <td>1.000</td> <td>PZ</td> </tr> <tr> <td>VL1047A1</td> <td>PORTAGOMM A D6 CODOLO D8</td> <td>1.000</td> <td>PZ</td> </tr> <tr> <td>VL1102A1</td> <td>FILTRO IN LINEA DET. + VNR BARBED 6 MM</td> <td>1.000</td> <td>PZ</td> </tr> <tr> <td>VL1128A1</td> <td>VALVOLA VNR BARBED D6</td> <td>1.000</td> <td>PZ</td> </tr> <tr> <td>VL1166A0</td> <td>RACCORDO A L BAM-BB6</td> <td>3.000</td> <td>PZ</td> </tr> <tr> <td>VL1174C0</td> <td>UGELLO CALIBRATO D1.2 MM</td> <td>1.000</td> <td>PZ</td> </tr> <tr> <td>VL1185A0</td> <td>DISTRIBUTOR E LAVAGGIO PLUS 2 VIE UGELLO</td> <td>1.000</td> <td>PZ</td> </tr> <tr> <td>VL1190A0</td> <td>DISTRIBUTOR E INGRESSI LAVAGGIO PLUS</td> <td>1.000</td> <td>PZ</td> </tr> <tr> <td>VL1214A0</td> <td>VALVOLA VNR BB6-BAIONET TA</td> <td>1.000</td> <td>PZ</td> </tr> <tr> <td>VL1398A0</td> <td>PRESSOSTAT O N.O. 1/4 M CI</td> <td>1.000</td> <td>PZ</td> </tr> <tr> <td>VM1605A0</td> <td>CLIP TWIST LOCK DIAM. 10,2-12,7 MM</td> <td>3.000</td> <td>PZ</td> </tr> <tr> <td>VM2172A0</td> <td>CLIP BLOCCAGGIO POMPA CON CIRCUITO</td> <td>4.000</td> <td>PZ</td> </tr> </tbody> </table>	Code	Description	Qty	UOM	TB3252A0	TB3132A-L=23 0MM EPDM BIANCO BLU	1.000	PZ	TB3614A0	TB2820A-L=96 MM NERO EPD	1.000	PZ	TB5360A0	TB3132A-TUB O EPDM TELATO BIANCO-BLU 550M	1.000	PZ	TB5362A0	TB3132A-TUB O EPDM TELATO BIANCO-BLU 230M	1.000	PZ	VI1220A1	VITE AUTOFIL. 4.2X11 TCS+ MARUTEX	1.000	PZ	VL1019A0	POMPA DETERGENTE VIBRAZIONE	1.000	PZ	VL1047A1	PORTAGOMM A D6 CODOLO D8	1.000	PZ	VL1102A1	FILTRO IN LINEA DET. + VNR BARBED 6 MM	1.000	PZ	VL1128A1	VALVOLA VNR BARBED D6	1.000	PZ	VL1166A0	RACCORDO A L BAM-BB6	3.000	PZ	VL1174C0	UGELLO CALIBRATO D1.2 MM	1.000	PZ	VL1185A0	DISTRIBUTOR E LAVAGGIO PLUS 2 VIE UGELLO	1.000	PZ	VL1190A0	DISTRIBUTOR E INGRESSI LAVAGGIO PLUS	1.000	PZ	VL1214A0	VALVOLA VNR BB6-BAIONET TA	1.000	PZ	VL1398A0	PRESSOSTAT O N.O. 1/4 M CI	1.000	PZ	VM1605A0	CLIP TWIST LOCK DIAM. 10,2-12,7 MM	3.000	PZ	VM2172A0	CLIP BLOCCAGGIO POMPA CON CIRCUITO	4.000	PZ
Code	Description	Qty	UOM																																																																										
TB3252A0	TB3132A-L=23 0MM EPDM BIANCO BLU	1.000	PZ																																																																										
TB3614A0	TB2820A-L=96 MM NERO EPD	1.000	PZ																																																																										
TB5360A0	TB3132A-TUB O EPDM TELATO BIANCO-BLU 550M	1.000	PZ																																																																										
TB5362A0	TB3132A-TUB O EPDM TELATO BIANCO-BLU 230M	1.000	PZ																																																																										
VI1220A1	VITE AUTOFIL. 4.2X11 TCS+ MARUTEX	1.000	PZ																																																																										
VL1019A0	POMPA DETERGENTE VIBRAZIONE	1.000	PZ																																																																										
VL1047A1	PORTAGOMM A D6 CODOLO D8	1.000	PZ																																																																										
VL1102A1	FILTRO IN LINEA DET. + VNR BARBED 6 MM	1.000	PZ																																																																										
VL1128A1	VALVOLA VNR BARBED D6	1.000	PZ																																																																										
VL1166A0	RACCORDO A L BAM-BB6	3.000	PZ																																																																										
VL1174C0	UGELLO CALIBRATO D1.2 MM	1.000	PZ																																																																										
VL1185A0	DISTRIBUTOR E LAVAGGIO PLUS 2 VIE UGELLO	1.000	PZ																																																																										
VL1190A0	DISTRIBUTOR E INGRESSI LAVAGGIO PLUS	1.000	PZ																																																																										
VL1214A0	VALVOLA VNR BB6-BAIONET TA	1.000	PZ																																																																										
VL1398A0	PRESSOSTAT O N.O. 1/4 M CI	1.000	PZ																																																																										
VM1605A0	CLIP TWIST LOCK DIAM. 10,2-12,7 MM	3.000	PZ																																																																										
VM2172A0	CLIP BLOCCAGGIO POMPA CON CIRCUITO	4.000	PZ																																																																										

COMPONENT			SPARE PART																																																																																						
Code	Description	Image	Code	Description	Kit components																																																																																				
VL1019A	POMPA DETERGENTE VIBRAZIONE		KVL1182A	ONE 1ROT CLEANING SYSTEM KIT (0311 EXC.)	<table border="1"> <thead> <tr> <th>Code</th> <th>Description</th> <th>Qty</th> <th>UOM</th> </tr> </thead> <tbody> <tr> <td>0H2202A1</td> <td>STAFFA LAVAGGIO ONE CON ELV STEAM</td> <td>1.000</td> <td>PZ</td> </tr> <tr> <td>EL1346A0</td> <td>CLIP BLOCCA PINZETTA RACCORDI D10 TIERRE</td> <td>2.000</td> <td>PZ</td> </tr> <tr> <td>EL1440A0</td> <td>ELETTROVALV OLA H2O AUTOPULENT E BAF EU</td> <td>1.000</td> <td>PZ</td> </tr> <tr> <td>GN1526A0</td> <td>O-RING D.INT6.9 SP1.8</td> <td>3.000</td> <td>PZ</td> </tr> <tr> <td>RC1019A0</td> <td>FASCETTA ELASTICA D10 ZINCATA</td> <td>12.000</td> <td>PZ</td> </tr> <tr> <td>RC1242A0</td> <td>TERMINALE CHIUSO D10</td> <td>2.000</td> <td>PZ</td> </tr> <tr> <td>RC1414A1</td> <td>FASCETTA STRINGITUBO A SCATTO D11.5-12.5</td> <td>4.000</td> <td>PZ</td> </tr> <tr> <td>TB2821A0</td> <td>TB2820A-L=40 MM EPDM NER</td> <td>4.000</td> <td>PZ</td> </tr> <tr> <td>TB3004A0</td> <td>TB2820A-L=57 0MM EPDM NERO</td> <td>1.000</td> <td>PZ</td> </tr> <tr> <td>TB3225B0</td> <td>TB2820A-TUB O EPDM NERO 670MM</td> <td>1.000</td> <td>PZ</td> </tr> <tr> <td>TB3614A0</td> <td>TB2820A-L=96 MM NERO EPD</td> <td>1.000</td> <td>PZ</td> </tr> <tr> <td>TB5361A0</td> <td>TB3132A-TUB O EPDM TELAIO BIANCO-BLU 670M</td> <td>1.000</td> <td>PZ</td> </tr> <tr> <td>VI1220A1</td> <td>VITE AUTOFIL. 4.2X11 TCS+ MARUTEX</td> <td>2.000</td> <td>PZ</td> </tr> <tr> <td>VL1019A0</td> <td>POMPA DETERGENTE VIBRAZIONE</td> <td></td> <td>1.000</td> <td>PZ</td> <td></td> <td></td> </tr> <tr> <td>VL1047A1</td> <td>PORTAGOMM A D6 CODOLO D8</td> <td></td> <td>1.000</td> <td>PZ</td> <td></td> <td></td> </tr> <tr> <td>VL1054B0</td> <td>DISTRIBUTOR E INGRESSI LAVAGGIO ON</td> <td></td> <td>1.000</td> <td>PZ</td> <td></td> <td></td> </tr> <tr> <td>VL1102A1</td> <td>FILTRO IN LINEA DET. + VNR BARBED 6 MM</td> <td></td> <td>1.000</td> <td>PZ</td> <td></td> <td></td> </tr> </tbody> </table>	Code	Description	Qty	UOM	0H2202A1	STAFFA LAVAGGIO ONE CON ELV STEAM	1.000	PZ	EL1346A0	CLIP BLOCCA PINZETTA RACCORDI D10 TIERRE	2.000	PZ	EL1440A0	ELETTROVALV OLA H2O AUTOPULENT E BAF EU	1.000	PZ	GN1526A0	O-RING D.INT6.9 SP1.8	3.000	PZ	RC1019A0	FASCETTA ELASTICA D10 ZINCATA	12.000	PZ	RC1242A0	TERMINALE CHIUSO D10	2.000	PZ	RC1414A1	FASCETTA STRINGITUBO A SCATTO D11.5-12.5	4.000	PZ	TB2821A0	TB2820A-L=40 MM EPDM NER	4.000	PZ	TB3004A0	TB2820A-L=57 0MM EPDM NERO	1.000	PZ	TB3225B0	TB2820A-TUB O EPDM NERO 670MM	1.000	PZ	TB3614A0	TB2820A-L=96 MM NERO EPD	1.000	PZ	TB5361A0	TB3132A-TUB O EPDM TELAIO BIANCO-BLU 670M	1.000	PZ	VI1220A1	VITE AUTOFIL. 4.2X11 TCS+ MARUTEX	2.000	PZ	VL1019A0	POMPA DETERGENTE VIBRAZIONE		1.000	PZ			VL1047A1	PORTAGOMM A D6 CODOLO D8		1.000	PZ			VL1054B0	DISTRIBUTOR E INGRESSI LAVAGGIO ON		1.000	PZ			VL1102A1	FILTRO IN LINEA DET. + VNR BARBED 6 MM		1.000	PZ		
Code	Description	Qty	UOM																																																																																						
0H2202A1	STAFFA LAVAGGIO ONE CON ELV STEAM	1.000	PZ																																																																																						
EL1346A0	CLIP BLOCCA PINZETTA RACCORDI D10 TIERRE	2.000	PZ																																																																																						
EL1440A0	ELETTROVALV OLA H2O AUTOPULENT E BAF EU	1.000	PZ																																																																																						
GN1526A0	O-RING D.INT6.9 SP1.8	3.000	PZ																																																																																						
RC1019A0	FASCETTA ELASTICA D10 ZINCATA	12.000	PZ																																																																																						
RC1242A0	TERMINALE CHIUSO D10	2.000	PZ																																																																																						
RC1414A1	FASCETTA STRINGITUBO A SCATTO D11.5-12.5	4.000	PZ																																																																																						
TB2821A0	TB2820A-L=40 MM EPDM NER	4.000	PZ																																																																																						
TB3004A0	TB2820A-L=57 0MM EPDM NERO	1.000	PZ																																																																																						
TB3225B0	TB2820A-TUB O EPDM NERO 670MM	1.000	PZ																																																																																						
TB3614A0	TB2820A-L=96 MM NERO EPD	1.000	PZ																																																																																						
TB5361A0	TB3132A-TUB O EPDM TELAIO BIANCO-BLU 670M	1.000	PZ																																																																																						
VI1220A1	VITE AUTOFIL. 4.2X11 TCS+ MARUTEX	2.000	PZ																																																																																						
VL1019A0	POMPA DETERGENTE VIBRAZIONE		1.000	PZ																																																																																					
VL1047A1	PORTAGOMM A D6 CODOLO D8		1.000	PZ																																																																																					
VL1054B0	DISTRIBUTOR E INGRESSI LAVAGGIO ON		1.000	PZ																																																																																					
VL1102A1	FILTRO IN LINEA DET. + VNR BARBED 6 MM		1.000	PZ																																																																																					

COMPONENT			SPARE PART																																																																																							
Code	Description	Image	Code	Description	Kit components																																																																																					
VL1019A	POMPA DETERGENTE VIBRAZIONE		KVL1182A	ONE 1ROT CLEANING SYSTEM KIT (0311 EXC.)	<table border="1"> <thead> <tr> <th>Code</th> <th>Description</th> <th>Qty</th> <th>UOM</th> </tr> </thead> <tbody> <tr> <td>VL1128A1</td> <td>VALVOLA VNR BARBED D6</td> <td>1.000</td> <td>PZ</td> </tr> <tr> <td>VL1166A0</td> <td>RACCORDO A L BAM-BB6</td> <td>1.000</td> <td>PZ</td> </tr> <tr> <td>VL1174C0</td> <td>UGELLO CALIBRATO D1.2 MM</td> <td>1.000</td> <td>PZ</td> </tr> <tr> <td>VL1191A0</td> <td>DISTRIBUTOR E USCITA LAVAGGIO ON</td> <td>1.000</td> <td>PZ</td> </tr> <tr> <td>VL1214A0</td> <td>VALVOLA VNR BB6-BAIONET TA</td> <td>1.000</td> <td>PZ</td> </tr> <tr> <td>VM2172A0</td> <td>CLIP BLOCCAGGIO POMPA CON CIRCUITO</td> <td>2.000</td> <td>PZ</td> </tr> </tbody> </table>	Code	Description	Qty	UOM	VL1128A1	VALVOLA VNR BARBED D6	1.000	PZ	VL1166A0	RACCORDO A L BAM-BB6	1.000	PZ	VL1174C0	UGELLO CALIBRATO D1.2 MM	1.000	PZ	VL1191A0	DISTRIBUTOR E USCITA LAVAGGIO ON	1.000	PZ	VL1214A0	VALVOLA VNR BB6-BAIONET TA	1.000	PZ	VM2172A0	CLIP BLOCCAGGIO POMPA CON CIRCUITO	2.000	PZ	<table border="1"> <thead> <tr> <th>Code</th> <th>Description</th> <th>Qty</th> <th>UOM</th> </tr> </thead> <tbody> <tr> <td>EL1346A0</td> <td>CLIP BLOCCA PINZETTA RACCORDI D10 TIERRE</td> <td>2.000</td> <td>PZ</td> </tr> <tr> <td>GN1526A0</td> <td>O-RING D.INT6.9 SP1.8</td> <td>3.000</td> <td>PZ</td> </tr> <tr> <td>RC1019A0</td> <td>FASCETTA ELASTICA D10 ZINCATA</td> <td>4.000</td> <td>PZ</td> </tr> <tr> <td>RC1130A0</td> <td>FASCETTA 130X2,6</td> <td>1.000</td> <td>PZ</td> </tr> <tr> <td>RC1131A0</td> <td>FASCETTA 200X2,6 BIANC</td> <td>3.000</td> <td>PZ</td> </tr> <tr> <td>RC1242A0</td> <td>TERMINALE CHIUSO D10</td> <td>2.000</td> <td>PZ</td> </tr> <tr> <td>TB2821A0</td> <td>TB2820A-L=40 MM EPDM NER</td> <td>3.000</td> <td>PZ</td> </tr> <tr> <td>VL1019A0</td> <td>POMPA DETERGENTE VIBRAZIONE</td> <td>1.000</td> <td>PZ</td> </tr> <tr> <td>VL1128A1</td> <td>VALVOLA VNR BARBED D6</td> <td>1.000</td> <td>PZ</td> </tr> <tr> <td>VL1174C0</td> <td>UGELLO CALIBRATO D1.2 MM</td> <td>1.000</td> <td>PZ</td> </tr> <tr> <td>VL1186A0</td> <td>DISTRIBUTOR E LAVAGGIO PLUS 3 VIE UGELLO</td> <td>1.000</td> <td>PZ</td> </tr> <tr> <td>VL1190A0</td> <td>DISTRIBUTOR E INGRESSI LAVAGGIO PLUS</td> <td>1.000</td> <td>PZ</td> </tr> <tr> <td>VM2172A0</td> <td>CLIP BLOCCAGGIO POMPA CON CIRCUITO</td> <td>1.000</td> <td>PZ</td> </tr> </tbody> </table>	Code	Description	Qty	UOM	EL1346A0	CLIP BLOCCA PINZETTA RACCORDI D10 TIERRE	2.000	PZ	GN1526A0	O-RING D.INT6.9 SP1.8	3.000	PZ	RC1019A0	FASCETTA ELASTICA D10 ZINCATA	4.000	PZ	RC1130A0	FASCETTA 130X2,6	1.000	PZ	RC1131A0	FASCETTA 200X2,6 BIANC	3.000	PZ	RC1242A0	TERMINALE CHIUSO D10	2.000	PZ	TB2821A0	TB2820A-L=40 MM EPDM NER	3.000	PZ	VL1019A0	POMPA DETERGENTE VIBRAZIONE	1.000	PZ	VL1128A1	VALVOLA VNR BARBED D6	1.000	PZ	VL1174C0	UGELLO CALIBRATO D1.2 MM	1.000	PZ	VL1186A0	DISTRIBUTOR E LAVAGGIO PLUS 3 VIE UGELLO	1.000	PZ	VL1190A0	DISTRIBUTOR E INGRESSI LAVAGGIO PLUS	1.000	PZ	VM2172A0	CLIP BLOCCAGGIO POMPA CON CIRCUITO	1.000	PZ
			Code	Description	Qty	UOM																																																																																				
VL1128A1	VALVOLA VNR BARBED D6	1.000	PZ																																																																																							
VL1166A0	RACCORDO A L BAM-BB6	1.000	PZ																																																																																							
VL1174C0	UGELLO CALIBRATO D1.2 MM	1.000	PZ																																																																																							
VL1191A0	DISTRIBUTOR E USCITA LAVAGGIO ON	1.000	PZ																																																																																							
VL1214A0	VALVOLA VNR BB6-BAIONET TA	1.000	PZ																																																																																							
VM2172A0	CLIP BLOCCAGGIO POMPA CON CIRCUITO	2.000	PZ																																																																																							
Code	Description	Qty	UOM																																																																																							
EL1346A0	CLIP BLOCCA PINZETTA RACCORDI D10 TIERRE	2.000	PZ																																																																																							
GN1526A0	O-RING D.INT6.9 SP1.8	3.000	PZ																																																																																							
RC1019A0	FASCETTA ELASTICA D10 ZINCATA	4.000	PZ																																																																																							
RC1130A0	FASCETTA 130X2,6	1.000	PZ																																																																																							
RC1131A0	FASCETTA 200X2,6 BIANC	3.000	PZ																																																																																							
RC1242A0	TERMINALE CHIUSO D10	2.000	PZ																																																																																							
TB2821A0	TB2820A-L=40 MM EPDM NER	3.000	PZ																																																																																							
VL1019A0	POMPA DETERGENTE VIBRAZIONE	1.000	PZ																																																																																							
VL1128A1	VALVOLA VNR BARBED D6	1.000	PZ																																																																																							
VL1174C0	UGELLO CALIBRATO D1.2 MM	1.000	PZ																																																																																							
VL1186A0	DISTRIBUTOR E LAVAGGIO PLUS 3 VIE UGELLO	1.000	PZ																																																																																							
VL1190A0	DISTRIBUTOR E INGRESSI LAVAGGIO PLUS	1.000	PZ																																																																																							
VM2172A0	CLIP BLOCCAGGIO POMPA CON CIRCUITO	1.000	PZ																																																																																							
			KVL0684A	>12/2019 2-3ROTOR ARM PLUS WASH PUMP KIT																																																																																						

COMPONENT			SPARE PART																																																																																									
Code	Description	Image	Code	Description	Kit components																																																																																							
VL1019A	POMPA DETERGENTE VIBRAZIONE		KVL0683A	>12/2019 1 ROTOR ARM PLUS WASH PUMP KIT	<table border="1"> <thead> <tr> <th>Code</th> <th>Description</th> <th>Qty</th> <th>UOM</th> </tr> </thead> <tbody> <tr> <td>EL1346A0</td> <td>CLIP BLOCCA PINZETTA RACCORDI D10 TIERRE</td> <td>2.000</td> <td>PZ</td> </tr> <tr> <td>GN1526A0</td> <td>O-RING D.INT6.9 SP1.8</td> <td>1.000</td> <td>PZ</td> </tr> <tr> <td>RC1019A0</td> <td>FASCETTA ELASTICA D10 ZINCATA</td> <td>4.000</td> <td>PZ</td> </tr> <tr> <td>RC1130A0</td> <td>FASCETTA 130X2,6</td> <td>1.000</td> <td>PZ</td> </tr> <tr> <td>RC1131A0</td> <td>FASCETTA 200X2,6 BIANC</td> <td>2.000</td> <td>PZ</td> </tr> <tr> <td>RC1242A0</td> <td>TERMINALE CHIUSO D10</td> <td>2.000</td> <td>PZ</td> </tr> <tr> <td>TB2821A0</td> <td>TB2820A-L=40 MM EPDM NER</td> <td>3.000</td> <td>PZ</td> </tr> <tr> <td>VL1019A0</td> <td>POMPA DETERGENTE VIBRAZIONE</td> <td>1.000</td> <td>PZ</td> </tr> <tr> <td>VL1128A1</td> <td>VALVOLA VNR BARBED D6</td> <td>1.000</td> <td>PZ</td> </tr> <tr> <td>VL1174C0</td> <td>UGELLO CALIBRATO D1.2 MM</td> <td>1.000</td> <td>PZ</td> </tr> <tr> <td>VL1185A0</td> <td>DISTRIBUTOR E LAVAGGIO PLUS 2 VIE UGELLO</td> <td>1.000</td> <td>PZ</td> </tr> <tr> <td>VL1190A0</td> <td>DISTRIBUTOR E INGRESSI LAVAGGIO PLUS</td> <td>1.000</td> <td>PZ</td> </tr> <tr> <td>VM2172A0</td> <td>CLIP BLOCCAGGIO POMPA CON CIRCUITO</td> <td>1.000</td> <td>PZ</td> </tr> </tbody> </table>	Code	Description	Qty	UOM	EL1346A0	CLIP BLOCCA PINZETTA RACCORDI D10 TIERRE	2.000	PZ	GN1526A0	O-RING D.INT6.9 SP1.8	1.000	PZ	RC1019A0	FASCETTA ELASTICA D10 ZINCATA	4.000	PZ	RC1130A0	FASCETTA 130X2,6	1.000	PZ	RC1131A0	FASCETTA 200X2,6 BIANC	2.000	PZ	RC1242A0	TERMINALE CHIUSO D10	2.000	PZ	TB2821A0	TB2820A-L=40 MM EPDM NER	3.000	PZ	VL1019A0	POMPA DETERGENTE VIBRAZIONE	1.000	PZ	VL1128A1	VALVOLA VNR BARBED D6	1.000	PZ	VL1174C0	UGELLO CALIBRATO D1.2 MM	1.000	PZ	VL1185A0	DISTRIBUTOR E LAVAGGIO PLUS 2 VIE UGELLO	1.000	PZ	VL1190A0	DISTRIBUTOR E INGRESSI LAVAGGIO PLUS	1.000	PZ	VM2172A0	CLIP BLOCCAGGIO POMPA CON CIRCUITO	1.000	PZ	KVL0682A	>12/2019 ONE/HOODS WASHING SYST PUMP KIT	<table border="1"> <thead> <tr> <th>Code</th> <th>Description</th> <th>Qty</th> <th>UOM</th> </tr> </thead> <tbody> <tr> <td>EL1346A0</td> <td>CLIP BLOCCA PINZETTA RACCORDI D10 TIERRE</td> <td>2.000</td> <td>PZ</td> </tr> <tr> <td>GN1526A0</td> <td>O-RING D.INT6.9 SP1.8</td> <td>1.000</td> <td>PZ</td> </tr> <tr> <td>RC1019A0</td> <td>FASCETTA ELASTICA D10 ZINCATA</td> <td>6.000</td> <td>PZ</td> </tr> <tr> <td>RC1242A0</td> <td>TERMINALE CHIUSO D10</td> <td>2.000</td> <td>PZ</td> </tr> <tr> <td>TB2821A0</td> <td>TB2820A-L=40 MM EPDM NER</td> <td>3.000</td> <td>PZ</td> </tr> <tr> <td>VL1019A0</td> <td>POMPA DETERGENTE VIBRAZIONE</td> <td>1.000</td> <td>PZ</td> </tr> </tbody> </table>	Code	Description	Qty	UOM	EL1346A0	CLIP BLOCCA PINZETTA RACCORDI D10 TIERRE	2.000	PZ	GN1526A0	O-RING D.INT6.9 SP1.8	1.000	PZ	RC1019A0	FASCETTA ELASTICA D10 ZINCATA	6.000	PZ	RC1242A0	TERMINALE CHIUSO D10	2.000	PZ	TB2821A0	TB2820A-L=40 MM EPDM NER	3.000	PZ	VL1019A0	POMPA DETERGENTE VIBRAZIONE	1.000	PZ
			Code	Description	Qty	UOM																																																																																						
EL1346A0	CLIP BLOCCA PINZETTA RACCORDI D10 TIERRE	2.000	PZ																																																																																									
GN1526A0	O-RING D.INT6.9 SP1.8	1.000	PZ																																																																																									
RC1019A0	FASCETTA ELASTICA D10 ZINCATA	4.000	PZ																																																																																									
RC1130A0	FASCETTA 130X2,6	1.000	PZ																																																																																									
RC1131A0	FASCETTA 200X2,6 BIANC	2.000	PZ																																																																																									
RC1242A0	TERMINALE CHIUSO D10	2.000	PZ																																																																																									
TB2821A0	TB2820A-L=40 MM EPDM NER	3.000	PZ																																																																																									
VL1019A0	POMPA DETERGENTE VIBRAZIONE	1.000	PZ																																																																																									
VL1128A1	VALVOLA VNR BARBED D6	1.000	PZ																																																																																									
VL1174C0	UGELLO CALIBRATO D1.2 MM	1.000	PZ																																																																																									
VL1185A0	DISTRIBUTOR E LAVAGGIO PLUS 2 VIE UGELLO	1.000	PZ																																																																																									
VL1190A0	DISTRIBUTOR E INGRESSI LAVAGGIO PLUS	1.000	PZ																																																																																									
VM2172A0	CLIP BLOCCAGGIO POMPA CON CIRCUITO	1.000	PZ																																																																																									
Code	Description	Qty	UOM																																																																																									
EL1346A0	CLIP BLOCCA PINZETTA RACCORDI D10 TIERRE	2.000	PZ																																																																																									
GN1526A0	O-RING D.INT6.9 SP1.8	1.000	PZ																																																																																									
RC1019A0	FASCETTA ELASTICA D10 ZINCATA	6.000	PZ																																																																																									
RC1242A0	TERMINALE CHIUSO D10	2.000	PZ																																																																																									
TB2821A0	TB2820A-L=40 MM EPDM NER	3.000	PZ																																																																																									
VL1019A0	POMPA DETERGENTE VIBRAZIONE	1.000	PZ																																																																																									

COMPONENT			SPARE PART																																																			
Code	Description	Image	Code	Description	Kit components																																																	
VL1019A	POMPA DETERGENTE VIBRAZIONE		KVL0682A	>12/2019 ONE/HOODS WASHING SYST PUMP KIT	<table border="1"> <thead> <tr> <th>Code</th> <th>Description</th> <th>Qty</th> <th>UOM</th> </tr> </thead> <tbody> <tr> <td>VL1054B0</td> <td>DISTRIBUTOR E INGRESSI LAVAGGIO ON</td> <td>1.000</td> <td>PZ</td> </tr> <tr> <td>VL1128A1</td> <td>VALVOLA VNR BARBED D6</td> <td>1.000</td> <td>PZ</td> </tr> <tr> <td>VL1174C0</td> <td>UGELLO CALIBRATO D1.2 MM</td> <td>1.000</td> <td>PZ</td> </tr> <tr> <td>VL1191A0</td> <td>DISTRIBUTOR E USCITA LAVAGGIO ON</td> <td>1.000</td> <td>PZ</td> </tr> <tr> <td>VM2172A0</td> <td>CLIP BLOCCAGGIO POMPA CON CIRCUITO</td> <td>1.000</td> <td>PZ</td> </tr> </tbody> </table>	Code	Description	Qty	UOM	VL1054B0	DISTRIBUTOR E INGRESSI LAVAGGIO ON	1.000	PZ	VL1128A1	VALVOLA VNR BARBED D6	1.000	PZ	VL1174C0	UGELLO CALIBRATO D1.2 MM	1.000	PZ	VL1191A0	DISTRIBUTOR E USCITA LAVAGGIO ON	1.000	PZ	VM2172A0	CLIP BLOCCAGGIO POMPA CON CIRCUITO	1.000	PZ																									
			Code	Description	Qty	UOM																																																
VL1054B0	DISTRIBUTOR E INGRESSI LAVAGGIO ON	1.000	PZ																																																			
VL1128A1	VALVOLA VNR BARBED D6	1.000	PZ																																																			
VL1174C0	UGELLO CALIBRATO D1.2 MM	1.000	PZ																																																			
VL1191A0	DISTRIBUTOR E USCITA LAVAGGIO ON	1.000	PZ																																																			
VM2172A0	CLIP BLOCCAGGIO POMPA CON CIRCUITO	1.000	PZ																																																			
KVL0001A	LM TOP CLEANING SYSTEM KIT	<table border="1"> <thead> <tr> <th>Code</th> <th>Description</th> <th>Qty</th> <th>UOM</th> </tr> </thead> <tbody> <tr> <td>0H1226B0</td> <td>LAMIERA CIRCUITO LAVAGGIO LineMiss</td> <td>1.000</td> <td>PZ</td> </tr> <tr> <td>EL1346A0</td> <td>CLIP BLOCCA PINZETTA RACCORDI D10 TIERRE</td> <td>2.000</td> <td>PZ</td> </tr> <tr> <td>EL1436B0</td> <td>ELETTROV. H2O JG D8-BARBED D6 VNR</td> <td>1.000</td> <td>PZ</td> </tr> <tr> <td>GN1312A0</td> <td>PASSACAVO GOMMA DE=26 DI=15 SP=10</td> <td>1.000</td> <td>PZ</td> </tr> <tr> <td>GN1526A0</td> <td>O-RING D.INT6.9 SP1.8</td> <td>1.000</td> <td>PZ</td> </tr> <tr> <td>RC1008A0</td> <td>FASCETTA ELASTICA D9 ZINCATA</td> <td>1.000</td> <td>PZ</td> </tr> <tr> <td>RC1019A0</td> <td>FASCETTA ELASTICA D10 ZINCATA</td> <td>10.000</td> <td>PZ</td> </tr> <tr> <td>RC1242A0</td> <td>TERMINALE CHIUSO D10</td> <td>2.000</td> <td>PZ</td> </tr> <tr> <td>TB1114A1</td> <td>TB2820A-ROC CHETTO DETERGENTE LM Top</td> <td>1.000</td> <td>PZ</td> </tr> <tr> <td>TB1116A0</td> <td>TB2343A-TUB O DETERGENTE AFFONDANTE</td> <td>1.000</td> <td>PZ</td> </tr> <tr> <td>TB2821A0</td> <td>TB2820A-L=40 MM EPDM NER</td> <td>4.000</td> <td>PZ</td> </tr> <tr> <td>VI1220A1</td> <td>VITE AUTOFIL. 4.2X11 TCS+ MARUTEX</td> <td>1.000</td> <td>PZ</td> </tr> </tbody> </table>	Code	Description	Qty	UOM	0H1226B0	LAMIERA CIRCUITO LAVAGGIO LineMiss	1.000	PZ	EL1346A0	CLIP BLOCCA PINZETTA RACCORDI D10 TIERRE	2.000	PZ	EL1436B0	ELETTROV. H2O JG D8-BARBED D6 VNR	1.000	PZ	GN1312A0	PASSACAVO GOMMA DE=26 DI=15 SP=10	1.000	PZ	GN1526A0	O-RING D.INT6.9 SP1.8	1.000	PZ	RC1008A0	FASCETTA ELASTICA D9 ZINCATA	1.000	PZ	RC1019A0	FASCETTA ELASTICA D10 ZINCATA	10.000	PZ	RC1242A0	TERMINALE CHIUSO D10	2.000	PZ	TB1114A1	TB2820A-ROC CHETTO DETERGENTE LM Top	1.000	PZ	TB1116A0	TB2343A-TUB O DETERGENTE AFFONDANTE	1.000	PZ	TB2821A0	TB2820A-L=40 MM EPDM NER	4.000	PZ	VI1220A1	VITE AUTOFIL. 4.2X11 TCS+ MARUTEX	1.000	PZ
Code	Description	Qty	UOM																																																			
0H1226B0	LAMIERA CIRCUITO LAVAGGIO LineMiss	1.000	PZ																																																			
EL1346A0	CLIP BLOCCA PINZETTA RACCORDI D10 TIERRE	2.000	PZ																																																			
EL1436B0	ELETTROV. H2O JG D8-BARBED D6 VNR	1.000	PZ																																																			
GN1312A0	PASSACAVO GOMMA DE=26 DI=15 SP=10	1.000	PZ																																																			
GN1526A0	O-RING D.INT6.9 SP1.8	1.000	PZ																																																			
RC1008A0	FASCETTA ELASTICA D9 ZINCATA	1.000	PZ																																																			
RC1019A0	FASCETTA ELASTICA D10 ZINCATA	10.000	PZ																																																			
RC1242A0	TERMINALE CHIUSO D10	2.000	PZ																																																			
TB1114A1	TB2820A-ROC CHETTO DETERGENTE LM Top	1.000	PZ																																																			
TB1116A0	TB2343A-TUB O DETERGENTE AFFONDANTE	1.000	PZ																																																			
TB2821A0	TB2820A-L=40 MM EPDM NER	4.000	PZ																																																			
VI1220A1	VITE AUTOFIL. 4.2X11 TCS+ MARUTEX	1.000	PZ																																																			

COMPONENT			SPARE PART																																																		
Code	Description	Image	Code	Description	Kit components																																																
VL1019A	POMPA DETERGENTE VIBRAZIONE		KVL0001A	LM TOP CLEANING SYSTEM KIT	<table border="1"> <thead> <tr> <th>Code</th> <th>Description</th> <th>Qty</th> <th>UOM</th> </tr> </thead> <tbody> <tr> <td>VL1019A0</td> <td>POMPA DETERGENTE VIBRAZIONE</td> <td>1.000</td> <td>PZ</td> </tr> <tr> <td>VL1047A1</td> <td>PORTAGOMM A D6 CODOLO D8</td> <td>1.000</td> <td>PZ</td> </tr> <tr> <td>VL1054B0</td> <td>DISTRIBUTOR E INGRESSI LAVAGGIO ON</td> <td>1.000</td> <td>PZ</td> </tr> <tr> <td>VL1061A0</td> <td>FILTRO RETINATO+AF FONDANTE+V NR XFT200</td> <td>1.000</td> <td>PZ</td> </tr> <tr> <td>VL1090A0</td> <td>TAPPO UNOX.DET&RI NSE 1L</td> <td>1.000</td> <td>PZ</td> </tr> <tr> <td>VL1128A1</td> <td>VALVOLA VNR BARBED D6</td> <td>1.000</td> <td>PZ</td> </tr> <tr> <td>VL1191A0</td> <td>DISTRIBUTOR E USCITA LAVAGGIO ON</td> <td>1.000</td> <td>PZ</td> </tr> <tr> <td>VM1066A0</td> <td>CLIP A SELLA PASSAGGIO CAVI</td> <td>3.000</td> <td>PZ</td> </tr> <tr> <td>VM1088A0</td> <td>FASCETTA A SCATTO D7.9-D9.2 PP</td> <td>1.000</td> <td>PZ</td> </tr> <tr> <td>VM1605A0</td> <td>CLIP TWIST LOCK DIAM. 10.2-12.7 MM</td> <td>1.000</td> <td>PZ</td> </tr> <tr> <td>VM2172A0</td> <td>CLIP BLOCCAGGIO POMPA CON CIRCUITO</td> <td>1.000</td> <td>PZ</td> </tr> </tbody> </table>	Code	Description	Qty	UOM	VL1019A0	POMPA DETERGENTE VIBRAZIONE	1.000	PZ	VL1047A1	PORTAGOMM A D6 CODOLO D8	1.000	PZ	VL1054B0	DISTRIBUTOR E INGRESSI LAVAGGIO ON	1.000	PZ	VL1061A0	FILTRO RETINATO+AF FONDANTE+V NR XFT200	1.000	PZ	VL1090A0	TAPPO UNOX.DET&RI NSE 1L	1.000	PZ	VL1128A1	VALVOLA VNR BARBED D6	1.000	PZ	VL1191A0	DISTRIBUTOR E USCITA LAVAGGIO ON	1.000	PZ	VM1066A0	CLIP A SELLA PASSAGGIO CAVI	3.000	PZ	VM1088A0	FASCETTA A SCATTO D7.9-D9.2 PP	1.000	PZ	VM1605A0	CLIP TWIST LOCK DIAM. 10.2-12.7 MM	1.000	PZ	VM2172A0	CLIP BLOCCAGGIO POMPA CON CIRCUITO	1.000	PZ
					Code	Description	Qty	UOM																																													
					VL1019A0	POMPA DETERGENTE VIBRAZIONE	1.000	PZ																																													
					VL1047A1	PORTAGOMM A D6 CODOLO D8	1.000	PZ																																													
					VL1054B0	DISTRIBUTOR E INGRESSI LAVAGGIO ON	1.000	PZ																																													
					VL1061A0	FILTRO RETINATO+AF FONDANTE+V NR XFT200	1.000	PZ																																													
					VL1090A0	TAPPO UNOX.DET&RI NSE 1L	1.000	PZ																																													
					VL1128A1	VALVOLA VNR BARBED D6	1.000	PZ																																													
					VL1191A0	DISTRIBUTOR E USCITA LAVAGGIO ON	1.000	PZ																																													
					VM1066A0	CLIP A SELLA PASSAGGIO CAVI	3.000	PZ																																													
					VM1088A0	FASCETTA A SCATTO D7.9-D9.2 PP	1.000	PZ																																													
					VM1605A0	CLIP TWIST LOCK DIAM. 10.2-12.7 MM	1.000	PZ																																													
					VM2172A0	CLIP BLOCCAGGIO POMPA CON CIRCUITO	1.000	PZ																																													
VL1128A	VALVOLA VNR BARBED D6		KVL1128A	D6 VNR BARBED VALVE KIT	<table border="1"> <thead> <tr> <th>Code</th> <th>Description</th> <th>Qty</th> <th>UOM</th> </tr> </thead> <tbody> <tr> <td>RC1019A0</td> <td>FASCETTA ELASTICA D10 ZINCATA</td> <td>4.000</td> <td>PZ</td> </tr> <tr> <td>TB2820A0</td> <td>TUBO EPDM 6X10</td> <td>0.080</td> <td>M</td> </tr> <tr> <td>VL1128A1</td> <td>VALVOLA VNR BARBED D6</td> <td>1.000</td> <td>PZ</td> </tr> </tbody> </table>	Code	Description	Qty	UOM	RC1019A0	FASCETTA ELASTICA D10 ZINCATA	4.000	PZ	TB2820A0	TUBO EPDM 6X10	0.080	M	VL1128A1	VALVOLA VNR BARBED D6	1.000	PZ																																
					Code	Description	Qty	UOM																																													
					RC1019A0	FASCETTA ELASTICA D10 ZINCATA	4.000	PZ																																													
TB2820A0	TUBO EPDM 6X10	0.080	M																																																		
VL1128A1	VALVOLA VNR BARBED D6	1.000	PZ																																																		
VL1174C	UGELLO CALIBRATO D1.2 M		VL1174C0	UGELLO CALIBRATO D1.2 M																																																	

COMPONENT			SPARE PART																																																																														
Code	Description	Image	Code	Description	Kit components																																																																												
VL1185A	DISTRIBUTORE LAVAGGIO PLUS 2 VIE UGELLO		KVL1213A	US PLUS COMPACT WASHING SYSTEM KIT	<table border="1"> <thead> <tr> <th>Code</th> <th>Description</th> <th>Qty</th> <th>UOM</th> </tr> </thead> <tbody> <tr> <td>0H2428A2</td> <td>LAMIERA IMPIANTO LAVAGGIO XECC PLUS</td> <td>1.000</td> <td>PZ</td> </tr> <tr> <td>EL1346A0</td> <td>CLIP BLOCCA PINZETTA RACCORDI D10 TIERRE</td> <td>2.000</td> <td>PZ</td> </tr> <tr> <td>EL1450A0</td> <td>ELETTROVALV OLA H2O AUTOPULENT E BAF USA</td> <td>3.000</td> <td>PZ</td> </tr> <tr> <td>GN1311A0</td> <td>PASSACAVO GOMMA DE=25 DI=12 SP=6,5</td> <td>1.000</td> <td>PZ</td> </tr> <tr> <td>GN1526A0</td> <td>O-RING D.INT6,9 SP1,8</td> <td>7.000</td> <td>PZ</td> </tr> <tr> <td>RC1018A0</td> <td>FASCETTA ELASTICA D12 ZINCATA</td> <td>5.000</td> <td>PZ</td> </tr> <tr> <td>RC1019A0</td> <td>FASCETTA ELASTICA D10 ZINCATA</td> <td>14.000</td> <td>PZ</td> </tr> <tr> <td>RC1130A0</td> <td>FASCETTA 130X2,6</td> <td>1.000</td> <td>PZ</td> </tr> <tr> <td>RC1131A0</td> <td>FASCETTA 200X2,6 BIANC</td> <td>1.000</td> <td>PZ</td> </tr> <tr> <td>RC1242A0</td> <td>TERMINALE CHIUSO D10</td> <td>2.000</td> <td>PZ</td> </tr> <tr> <td>RC1356A0</td> <td>RACCORDO DRITTO FIL. FEMM 8X1/4 BSP</td> <td>1.000</td> <td>PZ</td> </tr> <tr> <td>RC1414A1</td> <td>FASCETTA STRINGITUBO A SCATTO D11,5-12,5</td> <td>4.000</td> <td>PZ</td> </tr> <tr> <td>TB2821A0</td> <td>TB2820A-L=40 MM EPDM NER</td> <td>6.000</td> <td>PZ</td> </tr> <tr> <td>TB3004A0</td> <td>TB2820A-L=57 0MM EPDM NERO</td> <td>2.000</td> <td>PZ</td> </tr> <tr> <td>TB3005B0</td> <td>TB3132A-L=55 0MM EPDM BIANCO BLU</td> <td>1.000</td> <td>PZ</td> </tr> <tr> <td>TB3252A0</td> <td>TB3132A-L=23 0MM EPDM BIANCO BLU</td> <td>1.000</td> <td>PZ</td> </tr> <tr> <td>TB3469A0</td> <td>TB3132A-L=38 0MM EPDM BIANCO-BLU</td> <td>1.000</td> <td>PZ</td> </tr> <tr> <td>VH1220A1</td> <td>VITE AUTOFIL. 4,2X11 TCS+ MARUTEX</td> <td>3.000</td> <td>PZ</td> </tr> </tbody> </table>	Code	Description	Qty	UOM	0H2428A2	LAMIERA IMPIANTO LAVAGGIO XECC PLUS	1.000	PZ	EL1346A0	CLIP BLOCCA PINZETTA RACCORDI D10 TIERRE	2.000	PZ	EL1450A0	ELETTROVALV OLA H2O AUTOPULENT E BAF USA	3.000	PZ	GN1311A0	PASSACAVO GOMMA DE=25 DI=12 SP=6,5	1.000	PZ	GN1526A0	O-RING D.INT6,9 SP1,8	7.000	PZ	RC1018A0	FASCETTA ELASTICA D12 ZINCATA	5.000	PZ	RC1019A0	FASCETTA ELASTICA D10 ZINCATA	14.000	PZ	RC1130A0	FASCETTA 130X2,6	1.000	PZ	RC1131A0	FASCETTA 200X2,6 BIANC	1.000	PZ	RC1242A0	TERMINALE CHIUSO D10	2.000	PZ	RC1356A0	RACCORDO DRITTO FIL. FEMM 8X1/4 BSP	1.000	PZ	RC1414A1	FASCETTA STRINGITUBO A SCATTO D11,5-12,5	4.000	PZ	TB2821A0	TB2820A-L=40 MM EPDM NER	6.000	PZ	TB3004A0	TB2820A-L=57 0MM EPDM NERO	2.000	PZ	TB3005B0	TB3132A-L=55 0MM EPDM BIANCO BLU	1.000	PZ	TB3252A0	TB3132A-L=23 0MM EPDM BIANCO BLU	1.000	PZ	TB3469A0	TB3132A-L=38 0MM EPDM BIANCO-BLU	1.000	PZ	VH1220A1	VITE AUTOFIL. 4,2X11 TCS+ MARUTEX	3.000	PZ
Code	Description	Qty	UOM																																																																														
0H2428A2	LAMIERA IMPIANTO LAVAGGIO XECC PLUS	1.000	PZ																																																																														
EL1346A0	CLIP BLOCCA PINZETTA RACCORDI D10 TIERRE	2.000	PZ																																																																														
EL1450A0	ELETTROVALV OLA H2O AUTOPULENT E BAF USA	3.000	PZ																																																																														
GN1311A0	PASSACAVO GOMMA DE=25 DI=12 SP=6,5	1.000	PZ																																																																														
GN1526A0	O-RING D.INT6,9 SP1,8	7.000	PZ																																																																														
RC1018A0	FASCETTA ELASTICA D12 ZINCATA	5.000	PZ																																																																														
RC1019A0	FASCETTA ELASTICA D10 ZINCATA	14.000	PZ																																																																														
RC1130A0	FASCETTA 130X2,6	1.000	PZ																																																																														
RC1131A0	FASCETTA 200X2,6 BIANC	1.000	PZ																																																																														
RC1242A0	TERMINALE CHIUSO D10	2.000	PZ																																																																														
RC1356A0	RACCORDO DRITTO FIL. FEMM 8X1/4 BSP	1.000	PZ																																																																														
RC1414A1	FASCETTA STRINGITUBO A SCATTO D11,5-12,5	4.000	PZ																																																																														
TB2821A0	TB2820A-L=40 MM EPDM NER	6.000	PZ																																																																														
TB3004A0	TB2820A-L=57 0MM EPDM NERO	2.000	PZ																																																																														
TB3005B0	TB3132A-L=55 0MM EPDM BIANCO BLU	1.000	PZ																																																																														
TB3252A0	TB3132A-L=23 0MM EPDM BIANCO BLU	1.000	PZ																																																																														
TB3469A0	TB3132A-L=38 0MM EPDM BIANCO-BLU	1.000	PZ																																																																														
VH1220A1	VITE AUTOFIL. 4,2X11 TCS+ MARUTEX	3.000	PZ																																																																														

COMPONENT			SPARE PART																																																																																	
Code	Description	Image	Code	Description	Kit components																																																																															
VL1185A	DISTRIBUTORE LAVAGGIO PLUS 2 VIE UGELLO		KVL1213A	US PLUS COMPACT WASHING SYSTEM KIT	<table border="1"> <thead> <tr> <th>Code</th> <th>Description</th> <th>Qty</th> <th>UOM</th> </tr> </thead> <tbody> <tr> <td>VL1019A0</td> <td>POMPA DETERGENTE VIBRAZIONE</td> <td>1.000</td> <td>PZ</td> </tr> <tr> <td>VL1047A1</td> <td>PORTAGOMM A D6 CODOLO D8</td> <td>1.000</td> <td>PZ</td> </tr> <tr> <td>VL1054B0</td> <td>DISTRIBUTOR E INGRESSI LAVAGGIO ON</td> <td>1.000</td> <td>PZ</td> </tr> <tr> <td>VL1102A1</td> <td>FILTRO IN LINEA DET. + VNR BARBED 6 MM</td> <td>1.000</td> <td>PZ</td> </tr> <tr> <td>VL1127A1</td> <td>RACCORDO A T BARBED 6</td> <td>1.000</td> <td>PZ</td> </tr> <tr> <td>VL1128A1</td> <td>VALVOLA VNR BARBED D6</td> <td>2.000</td> <td>PZ</td> </tr> <tr> <td>VL1165A0</td> <td>RACCORDO DRITTO BAM-BB6</td> <td>1.000</td> <td>PZ</td> </tr> <tr> <td>VL1166A0</td> <td>RACCORDO A L BAM-BB6</td> <td>3.000</td> <td>PZ</td> </tr> <tr> <td>VL1174C0</td> <td>UGELLO CALIBRATO D1.2 MM</td> <td>1.000</td> <td>PZ</td> </tr> <tr> <td>VL1185A0</td> <td>DISTRIBUTOR E LAVAGGIO PLUS 2 VIE UGELLO</td> <td>1.000</td> <td>PZ</td> </tr> <tr> <td>VL1398A0</td> <td>PRESSOSTAT O.N.O. 1/4 M CI</td> <td>1.000</td> <td>PZ</td> </tr> <tr> <td>VM2172A0</td> <td>CLIP BLOCCAGGIO POMPA CON CIRCUITO</td> <td>3.000</td> <td>PZ</td> </tr> </tbody> </table>	Code	Description	Qty	UOM	VL1019A0	POMPA DETERGENTE VIBRAZIONE	1.000	PZ	VL1047A1	PORTAGOMM A D6 CODOLO D8	1.000	PZ	VL1054B0	DISTRIBUTOR E INGRESSI LAVAGGIO ON	1.000	PZ	VL1102A1	FILTRO IN LINEA DET. + VNR BARBED 6 MM	1.000	PZ	VL1127A1	RACCORDO A T BARBED 6	1.000	PZ	VL1128A1	VALVOLA VNR BARBED D6	2.000	PZ	VL1165A0	RACCORDO DRITTO BAM-BB6	1.000	PZ	VL1166A0	RACCORDO A L BAM-BB6	3.000	PZ	VL1174C0	UGELLO CALIBRATO D1.2 MM	1.000	PZ	VL1185A0	DISTRIBUTOR E LAVAGGIO PLUS 2 VIE UGELLO	1.000	PZ	VL1398A0	PRESSOSTAT O.N.O. 1/4 M CI	1.000	PZ	VM2172A0	CLIP BLOCCAGGIO POMPA CON CIRCUITO	3.000	PZ	KVL1212A	EUR COMPACT PLUS CLEANING SYSTEM KIT	<table border="1"> <thead> <tr> <th>Code</th> <th>Description</th> <th>Qty</th> <th>UOM</th> </tr> </thead> <tbody> <tr> <td>0H2428A2</td> <td>LAMIERA IMPIANTO LAVAGGIO XECC PLUS</td> <td>1.000</td> <td>PZ</td> </tr> <tr> <td>EL1346A0</td> <td>CLIP BLOCCA PINZETTA RACCORDI D10 TIERRE</td> <td>2.000</td> <td>PZ</td> </tr> <tr> <td>EL1440A0</td> <td>ELETTROVALV OLA H2O AUTOPULENT E BAF EU</td> <td>3.000</td> <td>PZ</td> </tr> <tr> <td>GN1311A0</td> <td>PASSACAVO GOMMA DE=25 DI=12 SP=6.5</td> <td>1.000</td> <td>PZ</td> </tr> <tr> <td>GN1526A0</td> <td>O-RING D.INT6.9 SP1.8</td> <td>7.000</td> <td>PZ</td> </tr> </tbody> </table>	Code	Description	Qty	UOM	0H2428A2	LAMIERA IMPIANTO LAVAGGIO XECC PLUS	1.000	PZ	EL1346A0	CLIP BLOCCA PINZETTA RACCORDI D10 TIERRE	2.000	PZ	EL1440A0	ELETTROVALV OLA H2O AUTOPULENT E BAF EU	3.000	PZ	GN1311A0	PASSACAVO GOMMA DE=25 DI=12 SP=6.5	1.000	PZ	GN1526A0	O-RING D.INT6.9 SP1.8	7.000	PZ
			Code	Description	Qty	UOM																																																																														
VL1019A0	POMPA DETERGENTE VIBRAZIONE	1.000	PZ																																																																																	
VL1047A1	PORTAGOMM A D6 CODOLO D8	1.000	PZ																																																																																	
VL1054B0	DISTRIBUTOR E INGRESSI LAVAGGIO ON	1.000	PZ																																																																																	
VL1102A1	FILTRO IN LINEA DET. + VNR BARBED 6 MM	1.000	PZ																																																																																	
VL1127A1	RACCORDO A T BARBED 6	1.000	PZ																																																																																	
VL1128A1	VALVOLA VNR BARBED D6	2.000	PZ																																																																																	
VL1165A0	RACCORDO DRITTO BAM-BB6	1.000	PZ																																																																																	
VL1166A0	RACCORDO A L BAM-BB6	3.000	PZ																																																																																	
VL1174C0	UGELLO CALIBRATO D1.2 MM	1.000	PZ																																																																																	
VL1185A0	DISTRIBUTOR E LAVAGGIO PLUS 2 VIE UGELLO	1.000	PZ																																																																																	
VL1398A0	PRESSOSTAT O.N.O. 1/4 M CI	1.000	PZ																																																																																	
VM2172A0	CLIP BLOCCAGGIO POMPA CON CIRCUITO	3.000	PZ																																																																																	
Code	Description	Qty	UOM																																																																																	
0H2428A2	LAMIERA IMPIANTO LAVAGGIO XECC PLUS	1.000	PZ																																																																																	
EL1346A0	CLIP BLOCCA PINZETTA RACCORDI D10 TIERRE	2.000	PZ																																																																																	
EL1440A0	ELETTROVALV OLA H2O AUTOPULENT E BAF EU	3.000	PZ																																																																																	
GN1311A0	PASSACAVO GOMMA DE=25 DI=12 SP=6.5	1.000	PZ																																																																																	
GN1526A0	O-RING D.INT6.9 SP1.8	7.000	PZ																																																																																	

COMPONENT			SPARE PART																																																																																		
Code	Description	Image	Code	Description	Kit components																																																																																
VL1185A	DISTRIBUTORE LAVAGGIO PLUS 2 VIE UGELLO		KVL1212A	EUR COMPACT PLUS CLEANING SYSTEM KIT	<table border="1"> <thead> <tr> <th>Code</th> <th>Description</th> <th>Qty</th> <th>UOM</th> </tr> </thead> <tbody> <tr> <td>RC1018A0</td> <td>FASCETTA ELASTICA D12 ZINCATA</td> <td>5.000</td> <td>PZ</td> </tr> <tr> <td>RC1019A0</td> <td>FASCETTA ELASTICA D10 ZINCATA</td> <td>14.000</td> <td>PZ</td> </tr> <tr> <td>RC1130A0</td> <td>FASCETTA 130X2,6</td> <td>1.000</td> <td>PZ</td> </tr> <tr> <td>RC1131A0</td> <td>FASCETTA 200X2,6 BIANC</td> <td>1.000</td> <td>PZ</td> </tr> <tr> <td>RC1242A0</td> <td>TERMINALE CHIUSO D10</td> <td>2.000</td> <td>PZ</td> </tr> <tr> <td>RC1356A0</td> <td>RACCORDO DRITTO FIL. FEMM 8X1/4 BSP</td> <td>1.000</td> <td>PZ</td> </tr> <tr> <td>RC1414A1</td> <td>FASCETTA STRINGITUBO A SCATTO D11,5-12,5</td> <td>4.000</td> <td>PZ</td> </tr> <tr> <td>TB2821A0</td> <td>TB2820A-L=40 MM EPDM NER</td> <td>6.000</td> <td>PZ</td> </tr> <tr> <td>TB3004A0</td> <td>TB2820A-L=57 0MM EPDM NERO</td> <td>2.000</td> <td>PZ</td> </tr> <tr> <td>TB3005B0</td> <td>TB3132A-L=55 0MM EPDM BIANCO BLU</td> <td>1.000</td> <td>PZ</td> </tr> <tr> <td>TB3252A0</td> <td>TB3132A-L=23 0MM EPDM BIANCO BLU</td> <td>1.000</td> <td>PZ</td> </tr> <tr> <td>TB3469A0</td> <td>TB3132A-L=38 0MM EPDM BIANCO-BLU</td> <td>1.000</td> <td>PZ</td> </tr> <tr> <td>VH1220A1</td> <td>VITE AUTOFIL. 4.2X11 TCS+ MARUTEX</td> <td>3.000</td> <td>PZ</td> </tr> <tr> <td>VL1019A0</td> <td>POMPA DETERGENTE VIBRAZIONE</td> <td>1.000</td> <td>PZ</td> </tr> <tr> <td>VL1047A1</td> <td>PORTAGOMM A D6 CODOLO D8</td> <td>1.000</td> <td>PZ</td> </tr> <tr> <td>VL1054B0</td> <td>DISTRIBUTOR E INGRESSI LAVAGGIO ON</td> <td>1.000</td> <td>PZ</td> </tr> <tr> <td>VL1102A1</td> <td>FILTRO IN LINEA DET. + VNR BARBED 6 MM</td> <td>1.000</td> <td>PZ</td> </tr> <tr> <td>VL1127A1</td> <td>RACCORDO A T BARBED 6</td> <td>1.000</td> <td>PZ</td> </tr> <tr> <td>VL1128A1</td> <td>VALVOLA VNR BARBED D6</td> <td>2.000</td> <td>PZ</td> </tr> </tbody> </table>	Code	Description	Qty	UOM	RC1018A0	FASCETTA ELASTICA D12 ZINCATA	5.000	PZ	RC1019A0	FASCETTA ELASTICA D10 ZINCATA	14.000	PZ	RC1130A0	FASCETTA 130X2,6	1.000	PZ	RC1131A0	FASCETTA 200X2,6 BIANC	1.000	PZ	RC1242A0	TERMINALE CHIUSO D10	2.000	PZ	RC1356A0	RACCORDO DRITTO FIL. FEMM 8X1/4 BSP	1.000	PZ	RC1414A1	FASCETTA STRINGITUBO A SCATTO D11,5-12,5	4.000	PZ	TB2821A0	TB2820A-L=40 MM EPDM NER	6.000	PZ	TB3004A0	TB2820A-L=57 0MM EPDM NERO	2.000	PZ	TB3005B0	TB3132A-L=55 0MM EPDM BIANCO BLU	1.000	PZ	TB3252A0	TB3132A-L=23 0MM EPDM BIANCO BLU	1.000	PZ	TB3469A0	TB3132A-L=38 0MM EPDM BIANCO-BLU	1.000	PZ	VH1220A1	VITE AUTOFIL. 4.2X11 TCS+ MARUTEX	3.000	PZ	VL1019A0	POMPA DETERGENTE VIBRAZIONE	1.000	PZ	VL1047A1	PORTAGOMM A D6 CODOLO D8	1.000	PZ	VL1054B0	DISTRIBUTOR E INGRESSI LAVAGGIO ON	1.000	PZ	VL1102A1	FILTRO IN LINEA DET. + VNR BARBED 6 MM	1.000	PZ	VL1127A1	RACCORDO A T BARBED 6	1.000	PZ	VL1128A1	VALVOLA VNR BARBED D6	2.000	PZ
Code	Description	Qty	UOM																																																																																		
RC1018A0	FASCETTA ELASTICA D12 ZINCATA	5.000	PZ																																																																																		
RC1019A0	FASCETTA ELASTICA D10 ZINCATA	14.000	PZ																																																																																		
RC1130A0	FASCETTA 130X2,6	1.000	PZ																																																																																		
RC1131A0	FASCETTA 200X2,6 BIANC	1.000	PZ																																																																																		
RC1242A0	TERMINALE CHIUSO D10	2.000	PZ																																																																																		
RC1356A0	RACCORDO DRITTO FIL. FEMM 8X1/4 BSP	1.000	PZ																																																																																		
RC1414A1	FASCETTA STRINGITUBO A SCATTO D11,5-12,5	4.000	PZ																																																																																		
TB2821A0	TB2820A-L=40 MM EPDM NER	6.000	PZ																																																																																		
TB3004A0	TB2820A-L=57 0MM EPDM NERO	2.000	PZ																																																																																		
TB3005B0	TB3132A-L=55 0MM EPDM BIANCO BLU	1.000	PZ																																																																																		
TB3252A0	TB3132A-L=23 0MM EPDM BIANCO BLU	1.000	PZ																																																																																		
TB3469A0	TB3132A-L=38 0MM EPDM BIANCO-BLU	1.000	PZ																																																																																		
VH1220A1	VITE AUTOFIL. 4.2X11 TCS+ MARUTEX	3.000	PZ																																																																																		
VL1019A0	POMPA DETERGENTE VIBRAZIONE	1.000	PZ																																																																																		
VL1047A1	PORTAGOMM A D6 CODOLO D8	1.000	PZ																																																																																		
VL1054B0	DISTRIBUTOR E INGRESSI LAVAGGIO ON	1.000	PZ																																																																																		
VL1102A1	FILTRO IN LINEA DET. + VNR BARBED 6 MM	1.000	PZ																																																																																		
VL1127A1	RACCORDO A T BARBED 6	1.000	PZ																																																																																		
VL1128A1	VALVOLA VNR BARBED D6	2.000	PZ																																																																																		

COMPONENT			SPARE PART																																															
Code	Description	Image	Code	Description	Kit components																																													
VL1185A	DISTRIBUTORE LAVAGGIO PLUS 2 VIE UGELLO		KVL1212A	EUR COMPACT PLUS CLEANING SYSTEM KIT	<table border="1"> <thead> <tr> <th>Code</th> <th>Description</th> <th>Qty</th> <th>UOM</th> </tr> </thead> <tbody> <tr> <td>VL1165A0</td> <td>RACCORDO DRITTO BAM-BB6</td> <td>1.000</td> <td>PZ</td> </tr> <tr> <td>VL1166A0</td> <td>RACCORDO A L BAM-BB6</td> <td>3.000</td> <td>PZ</td> </tr> <tr> <td>VL1174C0</td> <td>UGELLO CALIBRATO D1.2 MM</td> <td>1.000</td> <td>PZ</td> </tr> <tr> <td>VL1185A0</td> <td>DISTRIBUTORE E LAVAGGIO PLUS 2 VIE UGELLO</td> <td>1.000</td> <td>PZ</td> </tr> <tr> <td>VL1398A0</td> <td>PRESSOSTAT O.N.O. 1/4 M CI</td> <td>1.000</td> <td>PZ</td> </tr> <tr> <td>VM2172A0</td> <td>CLIP BLOCCAGGIO POMPA CON CIRCUITO</td> <td>3.000</td> <td>PZ</td> </tr> </tbody> </table>	Code	Description	Qty	UOM	VL1165A0	RACCORDO DRITTO BAM-BB6	1.000	PZ	VL1166A0	RACCORDO A L BAM-BB6	3.000	PZ	VL1174C0	UGELLO CALIBRATO D1.2 MM	1.000	PZ	VL1185A0	DISTRIBUTORE E LAVAGGIO PLUS 2 VIE UGELLO	1.000	PZ	VL1398A0	PRESSOSTAT O.N.O. 1/4 M CI	1.000	PZ	VM2172A0	CLIP BLOCCAGGIO POMPA CON CIRCUITO	3.000	PZ																	
			Code	Description	Qty	UOM																																												
VL1165A0	RACCORDO DRITTO BAM-BB6	1.000	PZ																																															
VL1166A0	RACCORDO A L BAM-BB6	3.000	PZ																																															
VL1174C0	UGELLO CALIBRATO D1.2 MM	1.000	PZ																																															
VL1185A0	DISTRIBUTORE E LAVAGGIO PLUS 2 VIE UGELLO	1.000	PZ																																															
VL1398A0	PRESSOSTAT O.N.O. 1/4 M CI	1.000	PZ																																															
VM2172A0	CLIP BLOCCAGGIO POMPA CON CIRCUITO	3.000	PZ																																															
KVL1209A	US PLUS 3 ROTOR ARMS WASHING SYSTEM KIT	<table border="1"> <thead> <tr> <th>Code</th> <th>Description</th> <th>Qty</th> <th>UOM</th> </tr> </thead> <tbody> <tr> <td>0H2354A2</td> <td>LAMIERA IMPIANTO LAVAGGIO PLUS XEVC-XEVL</td> <td>1.000</td> <td>PZ</td> </tr> <tr> <td>EL1346A0</td> <td>CLIP BLOCCA PINZETTA RACCORDI D10 TIERRE</td> <td>2.000</td> <td>PZ</td> </tr> <tr> <td>EL1450A0</td> <td>ELETTROVALV OLA H2O AUTOPULENT E BAF USA</td> <td>4.000</td> <td>PZ</td> </tr> <tr> <td>GN1526A0</td> <td>O-RING D.INT6.9 SP1.8</td> <td>9.000</td> <td>PZ</td> </tr> <tr> <td>RC1018A0</td> <td>FASCETTA ELASTICA D12 ZINCATA</td> <td>11.000</td> <td>PZ</td> </tr> <tr> <td>RC1019A0</td> <td>FASCETTA ELASTICA D10 ZINCATA</td> <td>14.000</td> <td>PZ</td> </tr> <tr> <td>RC1130A0</td> <td>FASCETTA 130X2,6</td> <td>1.000</td> <td>PZ</td> </tr> <tr> <td>RC1131A0</td> <td>FASCETTA 200X2,6 BIANCO</td> <td>3.000</td> <td>PZ</td> </tr> <tr> <td>RC1242A0</td> <td>TERMINALE CHIUSO D10</td> <td>2.000</td> <td>PZ</td> </tr> <tr> <td>RC1356A0</td> <td>RACCORDO DRITTO FIL. FEMM 8X1/4 BSP</td> <td>1.000</td> <td>PZ</td> </tr> <tr> <td>RC1414A1</td> <td>FASCETTA STRINGITUBO A SCATTO D11.5-12.5</td> <td>1.000</td> <td>PZ</td> </tr> </tbody> </table>	Code	Description	Qty	UOM	0H2354A2	LAMIERA IMPIANTO LAVAGGIO PLUS XEVC-XEVL	1.000	PZ	EL1346A0	CLIP BLOCCA PINZETTA RACCORDI D10 TIERRE	2.000	PZ	EL1450A0	ELETTROVALV OLA H2O AUTOPULENT E BAF USA	4.000	PZ	GN1526A0	O-RING D.INT6.9 SP1.8	9.000	PZ	RC1018A0	FASCETTA ELASTICA D12 ZINCATA	11.000	PZ	RC1019A0	FASCETTA ELASTICA D10 ZINCATA	14.000	PZ	RC1130A0	FASCETTA 130X2,6	1.000	PZ	RC1131A0	FASCETTA 200X2,6 BIANCO	3.000	PZ	RC1242A0	TERMINALE CHIUSO D10	2.000	PZ	RC1356A0	RACCORDO DRITTO FIL. FEMM 8X1/4 BSP	1.000	PZ	RC1414A1	FASCETTA STRINGITUBO A SCATTO D11.5-12.5	1.000	PZ
Code	Description	Qty	UOM																																															
0H2354A2	LAMIERA IMPIANTO LAVAGGIO PLUS XEVC-XEVL	1.000	PZ																																															
EL1346A0	CLIP BLOCCA PINZETTA RACCORDI D10 TIERRE	2.000	PZ																																															
EL1450A0	ELETTROVALV OLA H2O AUTOPULENT E BAF USA	4.000	PZ																																															
GN1526A0	O-RING D.INT6.9 SP1.8	9.000	PZ																																															
RC1018A0	FASCETTA ELASTICA D12 ZINCATA	11.000	PZ																																															
RC1019A0	FASCETTA ELASTICA D10 ZINCATA	14.000	PZ																																															
RC1130A0	FASCETTA 130X2,6	1.000	PZ																																															
RC1131A0	FASCETTA 200X2,6 BIANCO	3.000	PZ																																															
RC1242A0	TERMINALE CHIUSO D10	2.000	PZ																																															
RC1356A0	RACCORDO DRITTO FIL. FEMM 8X1/4 BSP	1.000	PZ																																															
RC1414A1	FASCETTA STRINGITUBO A SCATTO D11.5-12.5	1.000	PZ																																															



COMPONENT			SPARE PART					
Code	Description	Image	Code	Description	Kit components			
VL1185A	DISTRIBUTORE LAVAGGIO PLUS 2 VIE UGELLO		KVL1209A	US PLUS 3 ROTOR ARMS WASHING SYSTEM KIT	Code	Description	Qty	UOM
					TB2652A0	TB3132A-L750 MM BIANCO BLU EPDM	1.000	PZ
					TB2677A0	TB2820A-TUB O TANICA DET-FDET L1300MM	1.000	PZ
					TB2821A0	TB2820A-L=40 MM EPDM NER	4.000	PZ
					TB3004A0	TB2820A-L=57 0MM EPDM NERO	2.000	PZ
					TB3024C0	TB3132A-TUB O BLU 6X12 L=55MM	3.000	PZ
					TB3226A0	TB2820A-L110 MM COLLEGAMEN TO TANICA-LA	1.000	PZ
					TB3440A0	TB3132A-L=10 50MM EPDM BIANCO-BLU	1.000	PZ
					TB3614A0	TB2820A-L=96 MM NERO EPD	1.000	PZ
					VI1220A1	VITE AUTOFIL. 4.2X11 TCS+ MARUTEX	1.000	PZ
					VL1019A0	POMPA DETERGENTE VIBRAZIONE	1.000	PZ
					VL1102A1	FILTRO IN LINEA DET. + VNR BARBED 6 MM	1.000	PZ
					VL1127A1	RACCORDO A T BARBED 6	2.000	PZ
					VL1128A1	VALVOLA VNR BARBED D6	2.000	PZ
					VL1166A0	RACCORDO A L BAM-BB6	4.000	PZ
					VL1167A2	FLOW RESTRICTOR 3 GIRANTI GN21 B-B	1.000	PZ
					VL1174C0	UGELLO CALIBRATO D1.2 MM	1.000	PZ
					VL1186A0	DISTRIBUTOR E LAVAGGIO PLUS 3 VIE UGELLO	1.000	PZ
					VL1190A0	DISTRIBUTOR E INGRESSI LAVAGGIO PLUS	1.000	PZ

COMPONENT			SPARE PART																																																							
Code	Description	Image	Code	Description	Kit components																																																					
VL1185A	DISTRIBUTORE LAVAGGIO PLUS 2 VIE UGELLO		KVL1209A	US PLUS 3 ROTOR ARMS WASHING SYSTEM KIT	<table border="1"> <thead> <tr> <th>Code</th> <th>Description</th> <th>Qty</th> <th>UOM</th> </tr> </thead> <tbody> <tr> <td>VL1214A0</td> <td>VALVOLA VNR BB6-BAIONET TA</td> <td>1.000</td> <td>PZ</td> </tr> <tr> <td>VL1398A0</td> <td>PRESSOSTAT O.N.O. 1/4 M CI</td> <td>1.000</td> <td>PZ</td> </tr> <tr> <td>VM1605A0</td> <td>CLIP TWIST LOCK DIAM. 10,2-12,7 MM</td> <td>3.000</td> <td>PZ</td> </tr> <tr> <td>VM2172A0</td> <td>CLIP BLOCCAGGIO POMPA CON CIRCUITO</td> <td>5.000</td> <td>PZ</td> </tr> </tbody> </table>	Code	Description	Qty	UOM	VL1214A0	VALVOLA VNR BB6-BAIONET TA	1.000	PZ	VL1398A0	PRESSOSTAT O.N.O. 1/4 M CI	1.000	PZ	VM1605A0	CLIP TWIST LOCK DIAM. 10,2-12,7 MM	3.000	PZ	VM2172A0	CLIP BLOCCAGGIO POMPA CON CIRCUITO	5.000	PZ																																	
			Code	Description	Qty	UOM																																																				
VL1214A0	VALVOLA VNR BB6-BAIONET TA	1.000	PZ																																																							
VL1398A0	PRESSOSTAT O.N.O. 1/4 M CI	1.000	PZ																																																							
VM1605A0	CLIP TWIST LOCK DIAM. 10,2-12,7 MM	3.000	PZ																																																							
VM2172A0	CLIP BLOCCAGGIO POMPA CON CIRCUITO	5.000	PZ																																																							
KVL1207A	US PLUS 1 ROTOR ARM WASHING SYSTEM KIT	<table border="1"> <thead> <tr> <th>Code</th> <th>Description</th> <th>Qty</th> <th>UOM</th> </tr> </thead> <tbody> <tr> <td>0H2354A2</td> <td>LAMIERA IMPIANTO LAVAGGIO PLUS XEVC-XEVL</td> <td>1.000</td> <td>PZ</td> </tr> <tr> <td>EL1346A0</td> <td>CLIP BLOCCA PINZETTA RACCORDI D10 TIERRE</td> <td>2.000</td> <td>PZ</td> </tr> <tr> <td>EL1450A0</td> <td>ELETTROVALV OLA H2O AUTOPULENT E BAF USA</td> <td>3.000</td> <td>PZ</td> </tr> <tr> <td>GN1526A0</td> <td>O-RING D.INT6.9 SP1.8</td> <td>7.000</td> <td>PZ</td> </tr> <tr> <td>RC1018A0</td> <td>FASCETTA ELASTICA D12 ZINCATA</td> <td>1.000</td> <td>PZ</td> </tr> <tr> <td>RC1019A0</td> <td>FASCETTA ELASTICA D10 ZINCATA</td> <td>12.000</td> <td>PZ</td> </tr> <tr> <td>RC1130A0</td> <td>FASCETTA 130X2,6</td> <td>1.000</td> <td>PZ</td> </tr> <tr> <td>RC1131A0</td> <td>FASCETTA 200X2,6 BIANC</td> <td>2.000</td> <td>PZ</td> </tr> <tr> <td>RC1242A0</td> <td>TERMINALE CHIUSO D10</td> <td>2.000</td> <td>PZ</td> </tr> <tr> <td>RC1356A0</td> <td>RACCORDO DRITTO FIL. FEMM 8X1/4 BSP</td> <td>1.000</td> <td>PZ</td> </tr> <tr> <td>RC1414A1</td> <td>FASCETTA STRINGITUBO A SCATTO D11,5-12,5</td> <td>4.000</td> <td>PZ</td> </tr> <tr> <td>TB2821A0</td> <td>TB2820A-L=40 MM EPDM NER</td> <td>4.000</td> <td>PZ</td> </tr> <tr> <td>TB3004A0</td> <td>TB2820A-L=57 0MM EPDM NERO</td> <td>1.000</td> <td>PZ</td> </tr> </tbody> </table>	Code	Description	Qty	UOM	0H2354A2	LAMIERA IMPIANTO LAVAGGIO PLUS XEVC-XEVL	1.000	PZ	EL1346A0	CLIP BLOCCA PINZETTA RACCORDI D10 TIERRE	2.000	PZ	EL1450A0	ELETTROVALV OLA H2O AUTOPULENT E BAF USA	3.000	PZ	GN1526A0	O-RING D.INT6.9 SP1.8	7.000	PZ	RC1018A0	FASCETTA ELASTICA D12 ZINCATA	1.000	PZ	RC1019A0	FASCETTA ELASTICA D10 ZINCATA	12.000	PZ	RC1130A0	FASCETTA 130X2,6	1.000	PZ	RC1131A0	FASCETTA 200X2,6 BIANC	2.000	PZ	RC1242A0	TERMINALE CHIUSO D10	2.000	PZ	RC1356A0	RACCORDO DRITTO FIL. FEMM 8X1/4 BSP	1.000	PZ	RC1414A1	FASCETTA STRINGITUBO A SCATTO D11,5-12,5	4.000	PZ	TB2821A0	TB2820A-L=40 MM EPDM NER	4.000	PZ	TB3004A0	TB2820A-L=57 0MM EPDM NERO	1.000	PZ
Code	Description	Qty	UOM																																																							
0H2354A2	LAMIERA IMPIANTO LAVAGGIO PLUS XEVC-XEVL	1.000	PZ																																																							
EL1346A0	CLIP BLOCCA PINZETTA RACCORDI D10 TIERRE	2.000	PZ																																																							
EL1450A0	ELETTROVALV OLA H2O AUTOPULENT E BAF USA	3.000	PZ																																																							
GN1526A0	O-RING D.INT6.9 SP1.8	7.000	PZ																																																							
RC1018A0	FASCETTA ELASTICA D12 ZINCATA	1.000	PZ																																																							
RC1019A0	FASCETTA ELASTICA D10 ZINCATA	12.000	PZ																																																							
RC1130A0	FASCETTA 130X2,6	1.000	PZ																																																							
RC1131A0	FASCETTA 200X2,6 BIANC	2.000	PZ																																																							
RC1242A0	TERMINALE CHIUSO D10	2.000	PZ																																																							
RC1356A0	RACCORDO DRITTO FIL. FEMM 8X1/4 BSP	1.000	PZ																																																							
RC1414A1	FASCETTA STRINGITUBO A SCATTO D11,5-12,5	4.000	PZ																																																							
TB2821A0	TB2820A-L=40 MM EPDM NER	4.000	PZ																																																							
TB3004A0	TB2820A-L=57 0MM EPDM NERO	1.000	PZ																																																							

COMPONENT			SPARE PART																																																																																		
Code	Description	Image	Code	Description	Kit components																																																																																
VL1185A	DISTRIBUTORE LAVAGGIO PLUS 2 VIE UGELLO		KVL1207A	US PLUS 1 ROTOR ARM WASHING SYSTEM KIT	<table border="1"> <thead> <tr> <th>Code</th> <th>Description</th> <th>Qty</th> <th>UOM</th> </tr> </thead> <tbody> <tr> <td>TB3005B0</td> <td>TB3132A-L=55 0MM EPDM BIANCO BLU</td> <td>2.000</td> <td>PZ</td> </tr> <tr> <td>TB3024C0</td> <td>TB3132A-TUB O BLU 6X12 L=55MM</td> <td>1.000</td> <td>PZ</td> </tr> <tr> <td>TB3225B0</td> <td>TB2820A-TUB O EPDM NERO 670MM</td> <td>1.000</td> <td>PZ</td> </tr> <tr> <td>TB3252A0</td> <td>TB3132A-L=23 0MM EPDM BIANCO BLU</td> <td>1.000</td> <td>PZ</td> </tr> <tr> <td>TB3614A0</td> <td>TB2820A-L=96 MM NERO EPD</td> <td>1.000</td> <td>PZ</td> </tr> <tr> <td>VI1220A1</td> <td>VITE AUTOFIL. 4.2X11 TCS+ MARUTEX</td> <td>1.000</td> <td>PZ</td> </tr> <tr> <td>VL1019A0</td> <td>POMPA DETERGENTE VIBRAZIONE</td> <td>1.000</td> <td>PZ</td> </tr> <tr> <td>VL1047A1</td> <td>PORTAGOMM A D6 CODOLO D8</td> <td>1.000</td> <td>PZ</td> </tr> <tr> <td>VL1102A1</td> <td>FILTRO IN LINEA DET. + VNR BARBED 6 MM</td> <td>1.000</td> <td>PZ</td> </tr> <tr> <td>VL1127A1</td> <td>RACCORDO A T BARBED 6</td> <td>1.000</td> <td>PZ</td> </tr> <tr> <td>VL1128A1</td> <td>VALVOLA VNR BARBED D6</td> <td>1.000</td> <td>PZ</td> </tr> <tr> <td>VL1166A0</td> <td>RACCORDO A L BAM-BB6</td> <td>3.000</td> <td>PZ</td> </tr> <tr> <td>VL1174C0</td> <td>UGELLO CALIBRATO D1.2 MM</td> <td>1.000</td> <td>PZ</td> </tr> <tr> <td>VL1185A0</td> <td>DISTRIBUTOR E LAVAGGIO PLUS 2 VIE UGELLO</td> <td>1.000</td> <td>PZ</td> </tr> <tr> <td>VL1190A0</td> <td>DISTRIBUTOR E INGRESSI LAVAGGIO PLUS</td> <td>1.000</td> <td>PZ</td> </tr> <tr> <td>VL1214A0</td> <td>VALVOLA VNR BB6-BAIONET TA</td> <td>1.000</td> <td>PZ</td> </tr> <tr> <td>VL1398A0</td> <td>PRESSOSTAT O N.O. 1/4 M CI</td> <td>1.000</td> <td>PZ</td> </tr> <tr> <td>VM1605A0</td> <td>CLIP TWIST LOCK DIAM. 10.2-12.7 MM</td> <td>3.000</td> <td>PZ</td> </tr> <tr> <td>VM2172A0</td> <td>CLIP BLOCCAGGIO POMPA CON CIRCUITO</td> <td>4.000</td> <td>PZ</td> </tr> </tbody> </table>	Code	Description	Qty	UOM	TB3005B0	TB3132A-L=55 0MM EPDM BIANCO BLU	2.000	PZ	TB3024C0	TB3132A-TUB O BLU 6X12 L=55MM	1.000	PZ	TB3225B0	TB2820A-TUB O EPDM NERO 670MM	1.000	PZ	TB3252A0	TB3132A-L=23 0MM EPDM BIANCO BLU	1.000	PZ	TB3614A0	TB2820A-L=96 MM NERO EPD	1.000	PZ	VI1220A1	VITE AUTOFIL. 4.2X11 TCS+ MARUTEX	1.000	PZ	VL1019A0	POMPA DETERGENTE VIBRAZIONE	1.000	PZ	VL1047A1	PORTAGOMM A D6 CODOLO D8	1.000	PZ	VL1102A1	FILTRO IN LINEA DET. + VNR BARBED 6 MM	1.000	PZ	VL1127A1	RACCORDO A T BARBED 6	1.000	PZ	VL1128A1	VALVOLA VNR BARBED D6	1.000	PZ	VL1166A0	RACCORDO A L BAM-BB6	3.000	PZ	VL1174C0	UGELLO CALIBRATO D1.2 MM	1.000	PZ	VL1185A0	DISTRIBUTOR E LAVAGGIO PLUS 2 VIE UGELLO	1.000	PZ	VL1190A0	DISTRIBUTOR E INGRESSI LAVAGGIO PLUS	1.000	PZ	VL1214A0	VALVOLA VNR BB6-BAIONET TA	1.000	PZ	VL1398A0	PRESSOSTAT O N.O. 1/4 M CI	1.000	PZ	VM1605A0	CLIP TWIST LOCK DIAM. 10.2-12.7 MM	3.000	PZ	VM2172A0	CLIP BLOCCAGGIO POMPA CON CIRCUITO	4.000	PZ
					Code	Description	Qty	UOM																																																																													
					TB3005B0	TB3132A-L=55 0MM EPDM BIANCO BLU	2.000	PZ																																																																													
					TB3024C0	TB3132A-TUB O BLU 6X12 L=55MM	1.000	PZ																																																																													
					TB3225B0	TB2820A-TUB O EPDM NERO 670MM	1.000	PZ																																																																													
					TB3252A0	TB3132A-L=23 0MM EPDM BIANCO BLU	1.000	PZ																																																																													
					TB3614A0	TB2820A-L=96 MM NERO EPD	1.000	PZ																																																																													
					VI1220A1	VITE AUTOFIL. 4.2X11 TCS+ MARUTEX	1.000	PZ																																																																													
					VL1019A0	POMPA DETERGENTE VIBRAZIONE	1.000	PZ																																																																													
					VL1047A1	PORTAGOMM A D6 CODOLO D8	1.000	PZ																																																																													
					VL1102A1	FILTRO IN LINEA DET. + VNR BARBED 6 MM	1.000	PZ																																																																													
					VL1127A1	RACCORDO A T BARBED 6	1.000	PZ																																																																													
					VL1128A1	VALVOLA VNR BARBED D6	1.000	PZ																																																																													
					VL1166A0	RACCORDO A L BAM-BB6	3.000	PZ																																																																													
					VL1174C0	UGELLO CALIBRATO D1.2 MM	1.000	PZ																																																																													
					VL1185A0	DISTRIBUTOR E LAVAGGIO PLUS 2 VIE UGELLO	1.000	PZ																																																																													
					VL1190A0	DISTRIBUTOR E INGRESSI LAVAGGIO PLUS	1.000	PZ																																																																													
					VL1214A0	VALVOLA VNR BB6-BAIONET TA	1.000	PZ																																																																													
					VL1398A0	PRESSOSTAT O N.O. 1/4 M CI	1.000	PZ																																																																													
					VM1605A0	CLIP TWIST LOCK DIAM. 10.2-12.7 MM	3.000	PZ																																																																													
VM2172A0	CLIP BLOCCAGGIO POMPA CON CIRCUITO	4.000	PZ																																																																																		

COMPONENT			SPARE PART			
Code	Description	Image	Code	Description	Kit components	
VL1185A	DISTRIBUTORE LAVAGGIO PLUS 2 VIE UGELLO		KVL1183A	1 ROTOR ARM PLUS CLEANING SYSTEM KIT	Code	Description Qty UOM
					0H2354A2	LAMIERA 1.000 PZ IMPIANTO LAVAGGIO PLUS XEVC-XEVL
					EL1346A0	CLIP BLOCCA 2.000 PZ PINZETTA RACCORDI D10 TIERRE
					EL1440A0	ELETTROVALV 3.000 PZ OLA H2O AUTOPULENT E BAF EU
					GN1526A0	O-RING 7.000 PZ D.INT6.9 SP1.8
					RC1018A0	FASCETTA 1.000 PZ ELASTICA D12 ZINCATA
					RC1019A0	FASCETTA 12.000 PZ ELASTICA D10 ZINCATA
					RC1130A0	FASCETTA 1.000 PZ 130X2,6
					RC1131A0	FASCETTA 2.000 PZ 200X2,6 BIANC
					RC1242A0	TERMINALE 2.000 PZ CHIUSO D10
					RC1356A0	RACCORDO 1.000 PZ DRITTO FIL. FEMM 8X1/4 BSP
					RC1414A1	FASCETTA 4.000 PZ STRINGITUBO A SCATTO D11.5-12.5
					TB2821A0	TB2820A-L=40 4.000 PZ MM EPDM NER
					TB3004A0	TB2820A-L=57 1.000 PZ 0MM EPDM NERO
					TB3252A0	TB3132A-L=23 1.000 PZ 0MM EPDM BIANCO BLU
					TB3614A0	TB2820A-L=96 1.000 PZ MM NERO EPD
					TB5360A0	TB3132A-TUB 1.000 PZ O EPDM TELATO BIANCO-BLU 550M
					TB5362A0	TB3132A-TUB 1.000 PZ O EPDM TELATO BIANCO-BLU 230M

COMPONENT			SPARE PART																																																										
Code	Description	Image	Code	Description	Kit components																																																								
VL1185A	DISTRIBUTORE LAVAGGIO PLUS 2 VIE UGELLO		KVL1183A	1 ROTOR ARM PLUS CLEANING SYSTEM KIT	<table border="1"> <thead> <tr> <th>Code</th> <th>Description</th> <th>Qty</th> <th>UOM</th> </tr> </thead> <tbody> <tr> <td>VI1220A1</td> <td>VITE AUTOFIL. 4.2X11 TCS+ MARUTEX</td> <td>1.000</td> <td>PZ</td> </tr> <tr> <td>VL1019A0</td> <td>POMPA DETERGENTE VIBRAZIONE</td> <td>1.000</td> <td>PZ</td> </tr> <tr> <td>VL1047A1</td> <td>PORTAGOMM A D6 CODOLO D8</td> <td>1.000</td> <td>PZ</td> </tr> <tr> <td>VL1102A1</td> <td>FILTRO IN LINEA DET. + VNR BARBED 6 MM</td> <td>1.000</td> <td>PZ</td> </tr> <tr> <td>VL1128A1</td> <td>VALVOLA VNR BARBED D6</td> <td>1.000</td> <td>PZ</td> </tr> <tr> <td>VL1166A0</td> <td>RACCORDO A L BAM-BB6</td> <td>3.000</td> <td>PZ</td> </tr> <tr> <td>VL1174C0</td> <td>UGELLO CALIBRATO D1.2 MM</td> <td>1.000</td> <td>PZ</td> </tr> <tr> <td>VL1185A0</td> <td>DISTRIBUTOR E LAVAGGIO PLUS 2 VIE UGELLO</td> <td>1.000</td> <td>PZ</td> </tr> <tr> <td>VL1190A0</td> <td>DISTRIBUTOR E INGRESSI LAVAGGIO PLUS</td> <td>1.000</td> <td>PZ</td> </tr> <tr> <td>VL1214A0</td> <td>VALVOLA VNR BB6-BAIONET TA</td> <td>1.000</td> <td>PZ</td> </tr> <tr> <td>VL1398A0</td> <td>PRESSOSTAT O N.O. 1/4 M CI</td> <td>1.000</td> <td>PZ</td> </tr> <tr> <td>VM1605A0</td> <td>CLIP TWIST LOCK DIAM. 10.2-12.7 MM</td> <td>3.000</td> <td>PZ</td> </tr> <tr> <td>VM2172A0</td> <td>CLIP BLOCCAGGIO POMPA CON CIRCUITO</td> <td>4.000</td> <td>PZ</td> </tr> </tbody> </table>	Code	Description	Qty	UOM	VI1220A1	VITE AUTOFIL. 4.2X11 TCS+ MARUTEX	1.000	PZ	VL1019A0	POMPA DETERGENTE VIBRAZIONE	1.000	PZ	VL1047A1	PORTAGOMM A D6 CODOLO D8	1.000	PZ	VL1102A1	FILTRO IN LINEA DET. + VNR BARBED 6 MM	1.000	PZ	VL1128A1	VALVOLA VNR BARBED D6	1.000	PZ	VL1166A0	RACCORDO A L BAM-BB6	3.000	PZ	VL1174C0	UGELLO CALIBRATO D1.2 MM	1.000	PZ	VL1185A0	DISTRIBUTOR E LAVAGGIO PLUS 2 VIE UGELLO	1.000	PZ	VL1190A0	DISTRIBUTOR E INGRESSI LAVAGGIO PLUS	1.000	PZ	VL1214A0	VALVOLA VNR BB6-BAIONET TA	1.000	PZ	VL1398A0	PRESSOSTAT O N.O. 1/4 M CI	1.000	PZ	VM1605A0	CLIP TWIST LOCK DIAM. 10.2-12.7 MM	3.000	PZ	VM2172A0	CLIP BLOCCAGGIO POMPA CON CIRCUITO	4.000	PZ
Code	Description	Qty	UOM																																																										
VI1220A1	VITE AUTOFIL. 4.2X11 TCS+ MARUTEX	1.000	PZ																																																										
VL1019A0	POMPA DETERGENTE VIBRAZIONE	1.000	PZ																																																										
VL1047A1	PORTAGOMM A D6 CODOLO D8	1.000	PZ																																																										
VL1102A1	FILTRO IN LINEA DET. + VNR BARBED 6 MM	1.000	PZ																																																										
VL1128A1	VALVOLA VNR BARBED D6	1.000	PZ																																																										
VL1166A0	RACCORDO A L BAM-BB6	3.000	PZ																																																										
VL1174C0	UGELLO CALIBRATO D1.2 MM	1.000	PZ																																																										
VL1185A0	DISTRIBUTOR E LAVAGGIO PLUS 2 VIE UGELLO	1.000	PZ																																																										
VL1190A0	DISTRIBUTOR E INGRESSI LAVAGGIO PLUS	1.000	PZ																																																										
VL1214A0	VALVOLA VNR BB6-BAIONET TA	1.000	PZ																																																										
VL1398A0	PRESSOSTAT O N.O. 1/4 M CI	1.000	PZ																																																										
VM1605A0	CLIP TWIST LOCK DIAM. 10.2-12.7 MM	3.000	PZ																																																										
VM2172A0	CLIP BLOCCAGGIO POMPA CON CIRCUITO	4.000	PZ																																																										
			KVL0683A	>12/2019 1 ROTOR ARM PLUS WASH PUMP KIT	<table border="1"> <thead> <tr> <th>Code</th> <th>Description</th> <th>Qty</th> <th>UOM</th> </tr> </thead> <tbody> <tr> <td>EL1346A0</td> <td>CLIP BLOCCA PINZETTA RACCORDI D10 TIERRE</td> <td>2.000</td> <td>PZ</td> </tr> <tr> <td>GN1526A0</td> <td>O-RING D.INT6.9 SP1.8</td> <td>1.000</td> <td>PZ</td> </tr> <tr> <td>RC1019A0</td> <td>FASCETTA ELASTICA D10 ZINCATA</td> <td>4.000</td> <td>PZ</td> </tr> <tr> <td>RC1130A0</td> <td>FASCETTA 130X2,6</td> <td>1.000</td> <td>PZ</td> </tr> <tr> <td>RC1131A0</td> <td>FASCETTA 200X2.6 BIANC</td> <td>2.000</td> <td>PZ</td> </tr> </tbody> </table>	Code	Description	Qty	UOM	EL1346A0	CLIP BLOCCA PINZETTA RACCORDI D10 TIERRE	2.000	PZ	GN1526A0	O-RING D.INT6.9 SP1.8	1.000	PZ	RC1019A0	FASCETTA ELASTICA D10 ZINCATA	4.000	PZ	RC1130A0	FASCETTA 130X2,6	1.000	PZ	RC1131A0	FASCETTA 200X2.6 BIANC	2.000	PZ																																
Code	Description	Qty	UOM																																																										
EL1346A0	CLIP BLOCCA PINZETTA RACCORDI D10 TIERRE	2.000	PZ																																																										
GN1526A0	O-RING D.INT6.9 SP1.8	1.000	PZ																																																										
RC1019A0	FASCETTA ELASTICA D10 ZINCATA	4.000	PZ																																																										
RC1130A0	FASCETTA 130X2,6	1.000	PZ																																																										
RC1131A0	FASCETTA 200X2.6 BIANC	2.000	PZ																																																										

COMPONENT			SPARE PART																																										
Code	Description	Image	Code	Description	Kit components																																								
VL1185A	DISTRIBUTORE LAVAGGIO PLUS 2 VIE UGELLO		KVL0683A	>12/2019 1 ROTOR ARM PLUS WASH PUMP KIT	<table border="1"> <thead> <tr> <th>Code</th> <th>Description</th> <th>Qty</th> <th>UOM</th> </tr> </thead> <tbody> <tr> <td>RC1242A0</td> <td>TERMINALE CHIUSO D10</td> <td>2.000</td> <td>PZ</td> </tr> <tr> <td>TB2821A0</td> <td>TB2820A-L=40 MM EPDM NER</td> <td>3.000</td> <td>PZ</td> </tr> <tr> <td>VL1019A0</td> <td>POMPA DETERGENTE VIBRAZIONE</td> <td>1.000</td> <td>PZ</td> </tr> <tr> <td>VL1128A1</td> <td>VALVOLA VNR BARBED D6</td> <td>1.000</td> <td>PZ</td> </tr> <tr> <td>VL1174C0</td> <td>UGELLO CALIBRATO D1.2 MM</td> <td>1.000</td> <td>PZ</td> </tr> <tr> <td>VL1185A0</td> <td>DISTRIBUTORE E LAVAGGIO PLUS 2 VIE UGELLO</td> <td>1.000</td> <td>PZ</td> </tr> <tr> <td>VL1190A0</td> <td>DISTRIBUTORE E INGRESSI LAVAGGIO PLUS</td> <td>1.000</td> <td>PZ</td> </tr> <tr> <td>VM2172A0</td> <td>CLIP BLOCCAGGIO POMPA CON CIRCUITO</td> <td>1.000</td> <td>PZ</td> </tr> </tbody> </table>	Code	Description	Qty	UOM	RC1242A0	TERMINALE CHIUSO D10	2.000	PZ	TB2821A0	TB2820A-L=40 MM EPDM NER	3.000	PZ	VL1019A0	POMPA DETERGENTE VIBRAZIONE	1.000	PZ	VL1128A1	VALVOLA VNR BARBED D6	1.000	PZ	VL1174C0	UGELLO CALIBRATO D1.2 MM	1.000	PZ	VL1185A0	DISTRIBUTORE E LAVAGGIO PLUS 2 VIE UGELLO	1.000	PZ	VL1190A0	DISTRIBUTORE E INGRESSI LAVAGGIO PLUS	1.000	PZ	VM2172A0	CLIP BLOCCAGGIO POMPA CON CIRCUITO	1.000	PZ				
					Code	Description	Qty	UOM																																					
					RC1242A0	TERMINALE CHIUSO D10	2.000	PZ																																					
					TB2821A0	TB2820A-L=40 MM EPDM NER	3.000	PZ																																					
					VL1019A0	POMPA DETERGENTE VIBRAZIONE	1.000	PZ																																					
					VL1128A1	VALVOLA VNR BARBED D6	1.000	PZ																																					
					VL1174C0	UGELLO CALIBRATO D1.2 MM	1.000	PZ																																					
					VL1185A0	DISTRIBUTORE E LAVAGGIO PLUS 2 VIE UGELLO	1.000	PZ																																					
					VL1190A0	DISTRIBUTORE E INGRESSI LAVAGGIO PLUS	1.000	PZ																																					
					VM2172A0	CLIP BLOCCAGGIO POMPA CON CIRCUITO	1.000	PZ																																					
VL1190A	DISTRIBUTORE INGRESSI LAVAGGIO PLUS		KVL1209A	US PLUS 3 ROTOR ARMS WASHING SYSTEM KIT	<table border="1"> <thead> <tr> <th>Code</th> <th>Description</th> <th>Qty</th> <th>UOM</th> </tr> </thead> <tbody> <tr> <td>0H2354A2</td> <td>LAMIERA IMPIANTO LAVAGGIO PLUS XEVC-XEVL</td> <td>1.000</td> <td>PZ</td> </tr> <tr> <td>EL1346A0</td> <td>CLIP BLOCCA PINZETTA RACCORDI D10 TIERRE</td> <td>2.000</td> <td>PZ</td> </tr> <tr> <td>EL1450A0</td> <td>ELETTROVALV OLA H2O AUTOPULENT E BAF USA</td> <td>4.000</td> <td>PZ</td> </tr> <tr> <td>GN1526A0</td> <td>O-RING D.INT6.9 SP1.8</td> <td>9.000</td> <td>PZ</td> </tr> <tr> <td>RC1018A0</td> <td>FASCETTA ELASTICA D12 ZINCATA</td> <td>11.000</td> <td>PZ</td> </tr> <tr> <td>RC1019A0</td> <td>FASCETTA ELASTICA D10 ZINCATA</td> <td>14.000</td> <td>PZ</td> </tr> <tr> <td>RC1130A0</td> <td>FASCETTA 130X2,6</td> <td>1.000</td> <td>PZ</td> </tr> <tr> <td>RC1131A0</td> <td>FASCETTA 200X2,6 BIANC</td> <td>3.000</td> <td>PZ</td> </tr> <tr> <td>RC1242A0</td> <td>TERMINALE CHIUSO D10</td> <td>2.000</td> <td>PZ</td> </tr> </tbody> </table>	Code	Description	Qty	UOM	0H2354A2	LAMIERA IMPIANTO LAVAGGIO PLUS XEVC-XEVL	1.000	PZ	EL1346A0	CLIP BLOCCA PINZETTA RACCORDI D10 TIERRE	2.000	PZ	EL1450A0	ELETTROVALV OLA H2O AUTOPULENT E BAF USA	4.000	PZ	GN1526A0	O-RING D.INT6.9 SP1.8	9.000	PZ	RC1018A0	FASCETTA ELASTICA D12 ZINCATA	11.000	PZ	RC1019A0	FASCETTA ELASTICA D10 ZINCATA	14.000	PZ	RC1130A0	FASCETTA 130X2,6	1.000	PZ	RC1131A0	FASCETTA 200X2,6 BIANC	3.000	PZ	RC1242A0	TERMINALE CHIUSO D10	2.000	PZ
					Code	Description	Qty	UOM																																					
					0H2354A2	LAMIERA IMPIANTO LAVAGGIO PLUS XEVC-XEVL	1.000	PZ																																					
					EL1346A0	CLIP BLOCCA PINZETTA RACCORDI D10 TIERRE	2.000	PZ																																					
					EL1450A0	ELETTROVALV OLA H2O AUTOPULENT E BAF USA	4.000	PZ																																					
					GN1526A0	O-RING D.INT6.9 SP1.8	9.000	PZ																																					
					RC1018A0	FASCETTA ELASTICA D12 ZINCATA	11.000	PZ																																					
					RC1019A0	FASCETTA ELASTICA D10 ZINCATA	14.000	PZ																																					
					RC1130A0	FASCETTA 130X2,6	1.000	PZ																																					
					RC1131A0	FASCETTA 200X2,6 BIANC	3.000	PZ																																					
					RC1242A0	TERMINALE CHIUSO D10	2.000	PZ																																					

COMPONENT			SPARE PART																																																																														
Code	Description	Image	Code	Description	Kit components																																																																												
VL1190A	DISTRIBUTORE INGRESSI LAVAGGIO PLUS		KVL1209A	US PLUS 3 ROTOR ARMS WASHING SYSTEM KIT	<table border="1"> <thead> <tr> <th>Code</th> <th>Description</th> <th>Qty</th> <th>UOM</th> </tr> </thead> <tbody> <tr> <td>RC1356A0</td> <td>RACCORDO DRITTO FIL. FEMM 8X1/4 BSP</td> <td>1.000</td> <td>PZ</td> </tr> <tr> <td>RC1414A1</td> <td>FASCETTA STRINGITUBO A SCATTO D11.5-12.5</td> <td>1.000</td> <td>PZ</td> </tr> <tr> <td>TB2652A0</td> <td>TB3132A-L750 MM BIANCO BLU EPDM</td> <td>1.000</td> <td>PZ</td> </tr> <tr> <td>TB2677A0</td> <td>TB2820A-TUB O TANICA DET-FDET L1300MM</td> <td>1.000</td> <td>PZ</td> </tr> <tr> <td>TB2821A0</td> <td>TB2820A-L=40 MM EPDM NER</td> <td>4.000</td> <td>PZ</td> </tr> <tr> <td>TB3004A0</td> <td>TB2820A-L=57 0MM EPDM NERO</td> <td>2.000</td> <td>PZ</td> </tr> <tr> <td>TB3024C0</td> <td>TB3132A-TUB O BLU 6X12 L=55MM</td> <td>3.000</td> <td>PZ</td> </tr> <tr> <td>TB3226A0</td> <td>TB2820A-L110 MM COLLEGAMEN TO TANICA-LA</td> <td>1.000</td> <td>PZ</td> </tr> <tr> <td>TB3440A0</td> <td>TB3132A-L=10 50MM EPDM BIANCO-BLU</td> <td>1.000</td> <td>PZ</td> </tr> <tr> <td>TB3614A0</td> <td>TB2820A-L=96 MM NERO EPD</td> <td>1.000</td> <td>PZ</td> </tr> <tr> <td>VI1220A1</td> <td>VITE AUTOFIL. 4.2X11 TCS+ MARUTEX</td> <td>1.000</td> <td>PZ</td> </tr> <tr> <td>VL1019A0</td> <td>POMPA DETERGENTE VIBRAZIONE</td> <td>1.000</td> <td>PZ</td> </tr> <tr> <td>VL1102A1</td> <td>FILTRO IN LINEA DET. + VNR BARBED 6 MM</td> <td>1.000</td> <td>PZ</td> </tr> <tr> <td>VL1127A1</td> <td>RACCORDO A T BARBED 6</td> <td>2.000</td> <td>PZ</td> </tr> <tr> <td>VL1128A1</td> <td>VALVOLA VNR BARBED D6</td> <td>2.000</td> <td>PZ</td> </tr> <tr> <td>VL1166A0</td> <td>RACCORDO A L BAM-BB6</td> <td>4.000</td> <td>PZ</td> </tr> <tr> <td>VL1167A2</td> <td>FLOW RESTRICTOR 3 GIRANTI GN21 B-B</td> <td>1.000</td> <td>PZ</td> </tr> <tr> <td>VL1174C0</td> <td>UGELLO CALIBRATO D1.2 MM</td> <td>1.000</td> <td>PZ</td> </tr> </tbody> </table>	Code	Description	Qty	UOM	RC1356A0	RACCORDO DRITTO FIL. FEMM 8X1/4 BSP	1.000	PZ	RC1414A1	FASCETTA STRINGITUBO A SCATTO D11.5-12.5	1.000	PZ	TB2652A0	TB3132A-L750 MM BIANCO BLU EPDM	1.000	PZ	TB2677A0	TB2820A-TUB O TANICA DET-FDET L1300MM	1.000	PZ	TB2821A0	TB2820A-L=40 MM EPDM NER	4.000	PZ	TB3004A0	TB2820A-L=57 0MM EPDM NERO	2.000	PZ	TB3024C0	TB3132A-TUB O BLU 6X12 L=55MM	3.000	PZ	TB3226A0	TB2820A-L110 MM COLLEGAMEN TO TANICA-LA	1.000	PZ	TB3440A0	TB3132A-L=10 50MM EPDM BIANCO-BLU	1.000	PZ	TB3614A0	TB2820A-L=96 MM NERO EPD	1.000	PZ	VI1220A1	VITE AUTOFIL. 4.2X11 TCS+ MARUTEX	1.000	PZ	VL1019A0	POMPA DETERGENTE VIBRAZIONE	1.000	PZ	VL1102A1	FILTRO IN LINEA DET. + VNR BARBED 6 MM	1.000	PZ	VL1127A1	RACCORDO A T BARBED 6	2.000	PZ	VL1128A1	VALVOLA VNR BARBED D6	2.000	PZ	VL1166A0	RACCORDO A L BAM-BB6	4.000	PZ	VL1167A2	FLOW RESTRICTOR 3 GIRANTI GN21 B-B	1.000	PZ	VL1174C0	UGELLO CALIBRATO D1.2 MM	1.000	PZ
					Code	Description	Qty	UOM																																																																									
					RC1356A0	RACCORDO DRITTO FIL. FEMM 8X1/4 BSP	1.000	PZ																																																																									
					RC1414A1	FASCETTA STRINGITUBO A SCATTO D11.5-12.5	1.000	PZ																																																																									
					TB2652A0	TB3132A-L750 MM BIANCO BLU EPDM	1.000	PZ																																																																									
					TB2677A0	TB2820A-TUB O TANICA DET-FDET L1300MM	1.000	PZ																																																																									
					TB2821A0	TB2820A-L=40 MM EPDM NER	4.000	PZ																																																																									
					TB3004A0	TB2820A-L=57 0MM EPDM NERO	2.000	PZ																																																																									
					TB3024C0	TB3132A-TUB O BLU 6X12 L=55MM	3.000	PZ																																																																									
					TB3226A0	TB2820A-L110 MM COLLEGAMEN TO TANICA-LA	1.000	PZ																																																																									
					TB3440A0	TB3132A-L=10 50MM EPDM BIANCO-BLU	1.000	PZ																																																																									
					TB3614A0	TB2820A-L=96 MM NERO EPD	1.000	PZ																																																																									
					VI1220A1	VITE AUTOFIL. 4.2X11 TCS+ MARUTEX	1.000	PZ																																																																									
					VL1019A0	POMPA DETERGENTE VIBRAZIONE	1.000	PZ																																																																									
					VL1102A1	FILTRO IN LINEA DET. + VNR BARBED 6 MM	1.000	PZ																																																																									
					VL1127A1	RACCORDO A T BARBED 6	2.000	PZ																																																																									
					VL1128A1	VALVOLA VNR BARBED D6	2.000	PZ																																																																									
					VL1166A0	RACCORDO A L BAM-BB6	4.000	PZ																																																																									
					VL1167A2	FLOW RESTRICTOR 3 GIRANTI GN21 B-B	1.000	PZ																																																																									
					VL1174C0	UGELLO CALIBRATO D1.2 MM	1.000	PZ																																																																									

COMPONENT			SPARE PART																																											
Code	Description	Image	Code	Description	Kit components																																									
VL1190A	DISTRIBUTORE INGRESSI LAVAGGIO PLUS		KVL1209A	US PLUS 3 ROTOR ARMS WASHING SYSTEM KIT	<table border="1"> <thead> <tr> <th>Code</th> <th>Description</th> <th>Qty</th> <th>UOM</th> </tr> </thead> <tbody> <tr> <td>VL1186A0</td> <td>DISTRIBUTORE E LAVAGGIO PLUS 3 VIE UGELLO</td> <td>1.000</td> <td>PZ</td> </tr> <tr> <td>VL1190A0</td> <td>DISTRIBUTORE E INGRESSI LAVAGGIO PLUS</td> <td>1.000</td> <td>PZ</td> </tr> <tr> <td>VL1214A0</td> <td>VALVOLA VNR BB6-BAIONET TA</td> <td>1.000</td> <td>PZ</td> </tr> <tr> <td>VL1398A0</td> <td>PRESSOSTAT O.N.O. 1/4 M CI</td> <td>1.000</td> <td>PZ</td> </tr> <tr> <td>VM1605A0</td> <td>CLIP TWIST LOCK DIAM. 10,2-12,7 MM</td> <td>3.000</td> <td>PZ</td> </tr> <tr> <td>VM2172A0</td> <td>CLIP BLOCCAGGIO POMPA CON CIRCUITO</td> <td>5.000</td> <td>PZ</td> </tr> </tbody> </table>	Code	Description	Qty	UOM	VL1186A0	DISTRIBUTORE E LAVAGGIO PLUS 3 VIE UGELLO	1.000	PZ	VL1190A0	DISTRIBUTORE E INGRESSI LAVAGGIO PLUS	1.000	PZ	VL1214A0	VALVOLA VNR BB6-BAIONET TA	1.000	PZ	VL1398A0	PRESSOSTAT O.N.O. 1/4 M CI	1.000	PZ	VM1605A0	CLIP TWIST LOCK DIAM. 10,2-12,7 MM	3.000	PZ	VM2172A0	CLIP BLOCCAGGIO POMPA CON CIRCUITO	5.000	PZ													
			Code	Description	Qty	UOM																																								
VL1186A0	DISTRIBUTORE E LAVAGGIO PLUS 3 VIE UGELLO	1.000	PZ																																											
VL1190A0	DISTRIBUTORE E INGRESSI LAVAGGIO PLUS	1.000	PZ																																											
VL1214A0	VALVOLA VNR BB6-BAIONET TA	1.000	PZ																																											
VL1398A0	PRESSOSTAT O.N.O. 1/4 M CI	1.000	PZ																																											
VM1605A0	CLIP TWIST LOCK DIAM. 10,2-12,7 MM	3.000	PZ																																											
VM2172A0	CLIP BLOCCAGGIO POMPA CON CIRCUITO	5.000	PZ																																											
KVL1208A	US PLUS 2 ROTOR ARMS WASHING SYSTEM KIT	<table border="1"> <thead> <tr> <th>Code</th> <th>Description</th> <th>Qty</th> <th>UOM</th> </tr> </thead> <tbody> <tr> <td>0H2354A2</td> <td>LAMIERA IMPIANTO LAVAGGIO PLUS XEVC-XEVL</td> <td>1.000</td> <td>PZ</td> </tr> <tr> <td>EL1346A0</td> <td>CLIP BLOCCA PINZETTA RACCORDI D10 TIERRE</td> <td>2.000</td> <td>PZ</td> </tr> <tr> <td>EL1450A0</td> <td>ELETTROVALV OLA H2O AUTOPULENT E BAF USA</td> <td>4.000</td> <td>PZ</td> </tr> <tr> <td>GN1526A0</td> <td>O-RING D.INT6.9 SP1.8</td> <td>9.000</td> <td>PZ</td> </tr> <tr> <td>RC1018A0</td> <td>FASCETTA ELASTICA D12 ZINCATA</td> <td>3.000</td> <td>PZ</td> </tr> <tr> <td>RC1019A0</td> <td>FASCETTA ELASTICA D10 ZINCATA</td> <td>2.000</td> <td>PZ</td> </tr> <tr> <td>RC1130A0</td> <td>FASCETTA 130X2,6</td> <td>1.000</td> <td>PZ</td> </tr> <tr> <td>RC1131A0</td> <td>FASCETTA 200X2,6 BIANC</td> <td>3.000</td> <td>PZ</td> </tr> <tr> <td>RC1242A0</td> <td>TERMINALE CHIUSO D10</td> <td>2.000</td> <td>PZ</td> </tr> <tr> <td>RC1356A0</td> <td>RACCORDO DRITTO FIL. FEMM 8X1/4 BSP</td> <td>1.000</td> <td>PZ</td> </tr> </tbody> </table>	Code	Description	Qty	UOM	0H2354A2	LAMIERA IMPIANTO LAVAGGIO PLUS XEVC-XEVL	1.000	PZ	EL1346A0	CLIP BLOCCA PINZETTA RACCORDI D10 TIERRE	2.000	PZ	EL1450A0	ELETTROVALV OLA H2O AUTOPULENT E BAF USA	4.000	PZ	GN1526A0	O-RING D.INT6.9 SP1.8	9.000	PZ	RC1018A0	FASCETTA ELASTICA D12 ZINCATA	3.000	PZ	RC1019A0	FASCETTA ELASTICA D10 ZINCATA	2.000	PZ	RC1130A0	FASCETTA 130X2,6	1.000	PZ	RC1131A0	FASCETTA 200X2,6 BIANC	3.000	PZ	RC1242A0	TERMINALE CHIUSO D10	2.000	PZ	RC1356A0	RACCORDO DRITTO FIL. FEMM 8X1/4 BSP	1.000	PZ
Code	Description	Qty	UOM																																											
0H2354A2	LAMIERA IMPIANTO LAVAGGIO PLUS XEVC-XEVL	1.000	PZ																																											
EL1346A0	CLIP BLOCCA PINZETTA RACCORDI D10 TIERRE	2.000	PZ																																											
EL1450A0	ELETTROVALV OLA H2O AUTOPULENT E BAF USA	4.000	PZ																																											
GN1526A0	O-RING D.INT6.9 SP1.8	9.000	PZ																																											
RC1018A0	FASCETTA ELASTICA D12 ZINCATA	3.000	PZ																																											
RC1019A0	FASCETTA ELASTICA D10 ZINCATA	2.000	PZ																																											
RC1130A0	FASCETTA 130X2,6	1.000	PZ																																											
RC1131A0	FASCETTA 200X2,6 BIANC	3.000	PZ																																											
RC1242A0	TERMINALE CHIUSO D10	2.000	PZ																																											
RC1356A0	RACCORDO DRITTO FIL. FEMM 8X1/4 BSP	1.000	PZ																																											

COMPONENT			SPARE PART																																																																																		
Code	Description	Image	Code	Description	Kit components																																																																																
VL1190A	DISTRIBUTORE INGRESSI LAVAGGIO PLUS		KVL1208A	US PLUS 2 ROTOR ARMS WASHING SYSTEM KIT	<table border="1"> <thead> <tr> <th>Code</th> <th>Description</th> <th>Qty</th> <th>UOM</th> </tr> </thead> <tbody> <tr> <td>RC1414A1</td> <td>FASCETTA STRINGITUBO A SCATTO D11.5-12.5</td> <td>4.000</td> <td>PZ</td> </tr> <tr> <td>TB2821A0</td> <td>TB2820A-L=40 MM EPDM NER</td> <td>6.000</td> <td>PZ</td> </tr> <tr> <td>TB2994A0</td> <td>TB2820A-TUB O EPDM NERO 1000MM</td> <td>1.000</td> <td>PZ</td> </tr> <tr> <td>TB3004A0</td> <td>TB2820A-L=57 0MM EPDM NERO</td> <td>2.000</td> <td>PZ</td> </tr> <tr> <td>TB3005B0</td> <td>TB3132A-L=55 0MM EPDM BIANCO BLU</td> <td>1.000</td> <td>PZ</td> </tr> <tr> <td>TB3440A0</td> <td>TB3132A-L=10 50MM EPDM BIANCO-BLU</td> <td>1.000</td> <td>PZ</td> </tr> <tr> <td>VL1019A0</td> <td>POMPA DETERGENTE VIBRAZIONE</td> <td>1.000</td> <td>PZ</td> </tr> <tr> <td>VL1047A1</td> <td>PORTAGOMM A D6 CODOLO D8</td> <td>1.000</td> <td>PZ</td> </tr> <tr> <td>VL1102A1</td> <td>FILTRO IN LINEA DET. + VNR BARBED 6 MM</td> <td>1.000</td> <td>PZ</td> </tr> <tr> <td>VL1128A1</td> <td>VALVOLA VNR BARBED D6</td> <td>2.000</td> <td>PZ</td> </tr> <tr> <td>VL1141A1</td> <td>RACCORDO DRITTO BB6-BB6</td> <td>1.000</td> <td>PZ</td> </tr> <tr> <td>VL1166A0</td> <td>RACCORDO A L BAM-BB6</td> <td>4.000</td> <td>PZ</td> </tr> <tr> <td>VL1174C0</td> <td>UGELLO CALIBRATO D1.2 MM</td> <td>1.000</td> <td>PZ</td> </tr> <tr> <td>VL1186A0</td> <td>DISTRIBUTOR E LAVAGGIO PLUS 3 VIE UGELLO</td> <td>1.000</td> <td>PZ</td> </tr> <tr> <td>VL1190A0</td> <td>DISTRIBUTOR E INGRESSI LAVAGGIO PLUS</td> <td>1.000</td> <td>PZ</td> </tr> <tr> <td>VL1214A0</td> <td>VALVOLA VNR BB6-BAIONET TA</td> <td>1.000</td> <td>PZ</td> </tr> <tr> <td>VL1398A0</td> <td>PRESSOSTAT O N.O. 1/4 M CI</td> <td>1.000</td> <td>PZ</td> </tr> <tr> <td>VM1605A0</td> <td>CLIP TWIST LOCK DIAM. 10,2-12,7 MM</td> <td>3.000</td> <td>PZ</td> </tr> <tr> <td>VM2172A0</td> <td>CLIP BLOCCAGGIO POMPA CON CIRCUITO</td> <td>5.000</td> <td>PZ</td> </tr> </tbody> </table>	Code	Description	Qty	UOM	RC1414A1	FASCETTA STRINGITUBO A SCATTO D11.5-12.5	4.000	PZ	TB2821A0	TB2820A-L=40 MM EPDM NER	6.000	PZ	TB2994A0	TB2820A-TUB O EPDM NERO 1000MM	1.000	PZ	TB3004A0	TB2820A-L=57 0MM EPDM NERO	2.000	PZ	TB3005B0	TB3132A-L=55 0MM EPDM BIANCO BLU	1.000	PZ	TB3440A0	TB3132A-L=10 50MM EPDM BIANCO-BLU	1.000	PZ	VL1019A0	POMPA DETERGENTE VIBRAZIONE	1.000	PZ	VL1047A1	PORTAGOMM A D6 CODOLO D8	1.000	PZ	VL1102A1	FILTRO IN LINEA DET. + VNR BARBED 6 MM	1.000	PZ	VL1128A1	VALVOLA VNR BARBED D6	2.000	PZ	VL1141A1	RACCORDO DRITTO BB6-BB6	1.000	PZ	VL1166A0	RACCORDO A L BAM-BB6	4.000	PZ	VL1174C0	UGELLO CALIBRATO D1.2 MM	1.000	PZ	VL1186A0	DISTRIBUTOR E LAVAGGIO PLUS 3 VIE UGELLO	1.000	PZ	VL1190A0	DISTRIBUTOR E INGRESSI LAVAGGIO PLUS	1.000	PZ	VL1214A0	VALVOLA VNR BB6-BAIONET TA	1.000	PZ	VL1398A0	PRESSOSTAT O N.O. 1/4 M CI	1.000	PZ	VM1605A0	CLIP TWIST LOCK DIAM. 10,2-12,7 MM	3.000	PZ	VM2172A0	CLIP BLOCCAGGIO POMPA CON CIRCUITO	5.000	PZ
Code	Description	Qty	UOM																																																																																		
RC1414A1	FASCETTA STRINGITUBO A SCATTO D11.5-12.5	4.000	PZ																																																																																		
TB2821A0	TB2820A-L=40 MM EPDM NER	6.000	PZ																																																																																		
TB2994A0	TB2820A-TUB O EPDM NERO 1000MM	1.000	PZ																																																																																		
TB3004A0	TB2820A-L=57 0MM EPDM NERO	2.000	PZ																																																																																		
TB3005B0	TB3132A-L=55 0MM EPDM BIANCO BLU	1.000	PZ																																																																																		
TB3440A0	TB3132A-L=10 50MM EPDM BIANCO-BLU	1.000	PZ																																																																																		
VL1019A0	POMPA DETERGENTE VIBRAZIONE	1.000	PZ																																																																																		
VL1047A1	PORTAGOMM A D6 CODOLO D8	1.000	PZ																																																																																		
VL1102A1	FILTRO IN LINEA DET. + VNR BARBED 6 MM	1.000	PZ																																																																																		
VL1128A1	VALVOLA VNR BARBED D6	2.000	PZ																																																																																		
VL1141A1	RACCORDO DRITTO BB6-BB6	1.000	PZ																																																																																		
VL1166A0	RACCORDO A L BAM-BB6	4.000	PZ																																																																																		
VL1174C0	UGELLO CALIBRATO D1.2 MM	1.000	PZ																																																																																		
VL1186A0	DISTRIBUTOR E LAVAGGIO PLUS 3 VIE UGELLO	1.000	PZ																																																																																		
VL1190A0	DISTRIBUTOR E INGRESSI LAVAGGIO PLUS	1.000	PZ																																																																																		
VL1214A0	VALVOLA VNR BB6-BAIONET TA	1.000	PZ																																																																																		
VL1398A0	PRESSOSTAT O N.O. 1/4 M CI	1.000	PZ																																																																																		
VM1605A0	CLIP TWIST LOCK DIAM. 10,2-12,7 MM	3.000	PZ																																																																																		
VM2172A0	CLIP BLOCCAGGIO POMPA CON CIRCUITO	5.000	PZ																																																																																		

COMPONENT			SPARE PART																																																																															
Code	Description	Image	Code	Description	Kit components																																																																													
VL1190A	DISTRIBUTORE INGRESSI LAVAGGIO PLUS		KVL1207A	US PLUS 1 ROTOR ARM WASHING SYSTEM KIT	<table border="1"> <thead> <tr> <th>Code</th> <th>Description</th> <th>Qty</th> <th>UOM</th> </tr> </thead> <tbody> <tr> <td>0H2354A2</td> <td>LAMIERA IMPIANTO LAVAGGIO PLUS XEVC-XEVL</td> <td>1.000</td> <td>PZ</td> </tr> <tr> <td>EL1346A0</td> <td>CLIP BLOCCA PINZETTA RACCORDI D10 TIERRE</td> <td>2.000</td> <td>PZ</td> </tr> <tr> <td>EL1450A0</td> <td>ELETTROVALV OLA H2O AUTOPULENT E BAF USA</td> <td>3.000</td> <td>PZ</td> </tr> <tr> <td>GN1526A0</td> <td>O-RING D.INT6.9 SP1.8</td> <td>7.000</td> <td>PZ</td> </tr> <tr> <td>RC1018A0</td> <td>FASCETTA ELASTICA D12 ZINCATA</td> <td>1.000</td> <td>PZ</td> </tr> <tr> <td>RC1019A0</td> <td>FASCETTA ELASTICA D10 ZINCATA</td> <td>12.000</td> <td>PZ</td> </tr> <tr> <td>RC1130A0</td> <td>FASCETTA 130X2,6</td> <td>1.000</td> <td>PZ</td> </tr> <tr> <td>RC1131A0</td> <td>FASCETTA 200X2,6 BIANC</td> <td>2.000</td> <td>PZ</td> </tr> <tr> <td>RC1242A0</td> <td>TERMINALE CHIUSO D10</td> <td>2.000</td> <td>PZ</td> </tr> <tr> <td>RC1356A0</td> <td>RACCORDO DRITTO FIL. FEMM 8X1/4 BSP</td> <td>1.000</td> <td>PZ</td> </tr> <tr> <td>RC1414A1</td> <td>FASCETTA STRINGITUBO A SCATTO D11.5-12.5</td> <td>4.000</td> <td>PZ</td> </tr> <tr> <td>TB2821A0</td> <td>TB2820A-L=40 MM EPDM NER</td> <td>4.000</td> <td>PZ</td> </tr> <tr> <td>TB3004A0</td> <td>TB2820A-L=57 0MM EPDM NERO</td> <td>1.000</td> <td>PZ</td> </tr> <tr> <td>TB3005B0</td> <td>TB3132A-L=55 0MM EPDM BIANCO BLU</td> <td>2.000</td> <td>PZ</td> </tr> <tr> <td>TB3024C0</td> <td>TB3132A-TUB O BLU 6X12 L=55MM</td> <td>1.000</td> <td>PZ</td> </tr> <tr> <td>TB3225B0</td> <td>TB2820A-TUB O EPDM NERO 670MM</td> <td>1.000</td> <td>PZ</td> </tr> <tr> <td>TB3252A0</td> <td>TB3132A-L=23 0MM EPDM BIANCO BLU</td> <td>1.000</td> <td>PZ</td> </tr> <tr> <td>TB3614A0</td> <td>TB2820A-L=96 MM NERO EPD</td> <td>1.000</td> <td>PZ</td> </tr> </tbody> </table>		Code	Description	Qty	UOM	0H2354A2	LAMIERA IMPIANTO LAVAGGIO PLUS XEVC-XEVL	1.000	PZ	EL1346A0	CLIP BLOCCA PINZETTA RACCORDI D10 TIERRE	2.000	PZ	EL1450A0	ELETTROVALV OLA H2O AUTOPULENT E BAF USA	3.000	PZ	GN1526A0	O-RING D.INT6.9 SP1.8	7.000	PZ	RC1018A0	FASCETTA ELASTICA D12 ZINCATA	1.000	PZ	RC1019A0	FASCETTA ELASTICA D10 ZINCATA	12.000	PZ	RC1130A0	FASCETTA 130X2,6	1.000	PZ	RC1131A0	FASCETTA 200X2,6 BIANC	2.000	PZ	RC1242A0	TERMINALE CHIUSO D10	2.000	PZ	RC1356A0	RACCORDO DRITTO FIL. FEMM 8X1/4 BSP	1.000	PZ	RC1414A1	FASCETTA STRINGITUBO A SCATTO D11.5-12.5	4.000	PZ	TB2821A0	TB2820A-L=40 MM EPDM NER	4.000	PZ	TB3004A0	TB2820A-L=57 0MM EPDM NERO	1.000	PZ	TB3005B0	TB3132A-L=55 0MM EPDM BIANCO BLU	2.000	PZ	TB3024C0	TB3132A-TUB O BLU 6X12 L=55MM	1.000	PZ	TB3225B0	TB2820A-TUB O EPDM NERO 670MM	1.000	PZ	TB3252A0	TB3132A-L=23 0MM EPDM BIANCO BLU	1.000	PZ	TB3614A0	TB2820A-L=96 MM NERO EPD	1.000	PZ
Code	Description	Qty	UOM																																																																															
0H2354A2	LAMIERA IMPIANTO LAVAGGIO PLUS XEVC-XEVL	1.000	PZ																																																																															
EL1346A0	CLIP BLOCCA PINZETTA RACCORDI D10 TIERRE	2.000	PZ																																																																															
EL1450A0	ELETTROVALV OLA H2O AUTOPULENT E BAF USA	3.000	PZ																																																																															
GN1526A0	O-RING D.INT6.9 SP1.8	7.000	PZ																																																																															
RC1018A0	FASCETTA ELASTICA D12 ZINCATA	1.000	PZ																																																																															
RC1019A0	FASCETTA ELASTICA D10 ZINCATA	12.000	PZ																																																																															
RC1130A0	FASCETTA 130X2,6	1.000	PZ																																																																															
RC1131A0	FASCETTA 200X2,6 BIANC	2.000	PZ																																																																															
RC1242A0	TERMINALE CHIUSO D10	2.000	PZ																																																																															
RC1356A0	RACCORDO DRITTO FIL. FEMM 8X1/4 BSP	1.000	PZ																																																																															
RC1414A1	FASCETTA STRINGITUBO A SCATTO D11.5-12.5	4.000	PZ																																																																															
TB2821A0	TB2820A-L=40 MM EPDM NER	4.000	PZ																																																																															
TB3004A0	TB2820A-L=57 0MM EPDM NERO	1.000	PZ																																																																															
TB3005B0	TB3132A-L=55 0MM EPDM BIANCO BLU	2.000	PZ																																																																															
TB3024C0	TB3132A-TUB O BLU 6X12 L=55MM	1.000	PZ																																																																															
TB3225B0	TB2820A-TUB O EPDM NERO 670MM	1.000	PZ																																																																															
TB3252A0	TB3132A-L=23 0MM EPDM BIANCO BLU	1.000	PZ																																																																															
TB3614A0	TB2820A-L=96 MM NERO EPD	1.000	PZ																																																																															

COMPONENT			SPARE PART																																																																													
Code	Description	Image	Code	Description	Kit components																																																																											
VL1190A	DISTRIBUTORE INGRESSI LAVAGGIO PLUS		KVL1207A	US PLUS 1 ROTOR ARM WASHING SYSTEM KIT	<table border="1"> <thead> <tr> <th>Code</th> <th>Description</th> <th>Qty</th> <th>UOM</th> </tr> </thead> <tbody> <tr> <td>VI1220A1</td> <td>VITE AUTOFIL. 4.2X11 TCS+ MARUTEX</td> <td>1.000</td> <td>PZ</td> </tr> <tr> <td>VL1019A0</td> <td>POMPA DETERGENTE VIBRAZIONE</td> <td>1.000</td> <td>PZ</td> </tr> <tr> <td>VL1047A1</td> <td>PORTAGOMM A D6 CODOLO D8</td> <td>1.000</td> <td>PZ</td> </tr> <tr> <td>VL1102A1</td> <td>FILTRO IN LINEA DET. + VNR BARBED 6 MM</td> <td>1.000</td> <td>PZ</td> </tr> <tr> <td>VL1127A1</td> <td>RACCORDO A T BARBED 6</td> <td>1.000</td> <td>PZ</td> </tr> <tr> <td>VL1128A1</td> <td>VALVOLA VNR BARBED D6</td> <td>1.000</td> <td>PZ</td> </tr> <tr> <td>VL1166A0</td> <td>RACCORDO A L BAM-BB6</td> <td>3.000</td> <td>PZ</td> </tr> <tr> <td>VL1174C0</td> <td>UGELLO CALIBRATO D1.2 MM</td> <td>1.000</td> <td>PZ</td> </tr> <tr> <td>VL1185A0</td> <td>DISTRIBUTOR E LAVAGGIO PLUS 2 VIE UGELLO</td> <td>1.000</td> <td>PZ</td> </tr> <tr> <td>VL1190A0</td> <td>DISTRIBUTOR E INGRESSI LAVAGGIO PLUS</td> <td>1.000</td> <td>PZ</td> </tr> <tr> <td>VL1214A0</td> <td>VALVOLA VNR BB6-BAIONET TA</td> <td>1.000</td> <td>PZ</td> </tr> <tr> <td>VL1398A0</td> <td>PRESSOSTAT O.N.O. 1/4 M CI</td> <td>1.000</td> <td>PZ</td> </tr> <tr> <td>VM1605A0</td> <td>CLIP TWIST LOCK DIAM. 10,2-12,7 MM</td> <td>3.000</td> <td>PZ</td> </tr> <tr> <td>VM2172A0</td> <td>CLIP BLOCCAGGIO POMPA CON CIRCUITO</td> <td>4.000</td> <td>PZ</td> </tr> </tbody> </table>	Code	Description	Qty	UOM	VI1220A1	VITE AUTOFIL. 4.2X11 TCS+ MARUTEX	1.000	PZ	VL1019A0	POMPA DETERGENTE VIBRAZIONE	1.000	PZ	VL1047A1	PORTAGOMM A D6 CODOLO D8	1.000	PZ	VL1102A1	FILTRO IN LINEA DET. + VNR BARBED 6 MM	1.000	PZ	VL1127A1	RACCORDO A T BARBED 6	1.000	PZ	VL1128A1	VALVOLA VNR BARBED D6	1.000	PZ	VL1166A0	RACCORDO A L BAM-BB6	3.000	PZ	VL1174C0	UGELLO CALIBRATO D1.2 MM	1.000	PZ	VL1185A0	DISTRIBUTOR E LAVAGGIO PLUS 2 VIE UGELLO	1.000	PZ	VL1190A0	DISTRIBUTOR E INGRESSI LAVAGGIO PLUS	1.000	PZ	VL1214A0	VALVOLA VNR BB6-BAIONET TA	1.000	PZ	VL1398A0	PRESSOSTAT O.N.O. 1/4 M CI	1.000	PZ	VM1605A0	CLIP TWIST LOCK DIAM. 10,2-12,7 MM	3.000	PZ	VM2172A0	CLIP BLOCCAGGIO POMPA CON CIRCUITO	4.000	PZ	KVL1187A	3 ROTOR ARMS PLUS EU CLEANING SYSTEM KIT	<table border="1"> <thead> <tr> <th>Code</th> <th>Description</th> <th>Qty</th> <th>UOM</th> </tr> </thead> <tbody> <tr> <td>0H2354A2</td> <td>LAMIERA IMPIANTO LAVAGGIO PLUS XEVC-XEVL</td> <td>1.000</td> <td>PZ</td> </tr> <tr> <td>EL1346A0</td> <td>CLIP BLOCCA PINZETTA RACCORDI D10 TIERRE</td> <td>2.000</td> <td>PZ</td> </tr> </tbody> </table>	Code	Description	Qty	UOM	0H2354A2	LAMIERA IMPIANTO LAVAGGIO PLUS XEVC-XEVL	1.000	PZ	EL1346A0	CLIP BLOCCA PINZETTA RACCORDI D10 TIERRE	2.000	PZ
			Code	Description	Qty	UOM																																																																										
VI1220A1	VITE AUTOFIL. 4.2X11 TCS+ MARUTEX	1.000	PZ																																																																													
VL1019A0	POMPA DETERGENTE VIBRAZIONE	1.000	PZ																																																																													
VL1047A1	PORTAGOMM A D6 CODOLO D8	1.000	PZ																																																																													
VL1102A1	FILTRO IN LINEA DET. + VNR BARBED 6 MM	1.000	PZ																																																																													
VL1127A1	RACCORDO A T BARBED 6	1.000	PZ																																																																													
VL1128A1	VALVOLA VNR BARBED D6	1.000	PZ																																																																													
VL1166A0	RACCORDO A L BAM-BB6	3.000	PZ																																																																													
VL1174C0	UGELLO CALIBRATO D1.2 MM	1.000	PZ																																																																													
VL1185A0	DISTRIBUTOR E LAVAGGIO PLUS 2 VIE UGELLO	1.000	PZ																																																																													
VL1190A0	DISTRIBUTOR E INGRESSI LAVAGGIO PLUS	1.000	PZ																																																																													
VL1214A0	VALVOLA VNR BB6-BAIONET TA	1.000	PZ																																																																													
VL1398A0	PRESSOSTAT O.N.O. 1/4 M CI	1.000	PZ																																																																													
VM1605A0	CLIP TWIST LOCK DIAM. 10,2-12,7 MM	3.000	PZ																																																																													
VM2172A0	CLIP BLOCCAGGIO POMPA CON CIRCUITO	4.000	PZ																																																																													
Code	Description	Qty	UOM																																																																													
0H2354A2	LAMIERA IMPIANTO LAVAGGIO PLUS XEVC-XEVL	1.000	PZ																																																																													
EL1346A0	CLIP BLOCCA PINZETTA RACCORDI D10 TIERRE	2.000	PZ																																																																													

COMPONENT			SPARE PART																																																																														
Code	Description	Image	Code	Description	Kit components																																																																												
VL1190A	DISTRIBUTORE INGRESSI LAVAGGIO PLUS		KVL1187A	3 ROTOR ARMS PLUS EU CLEANING SYSTEM KIT	<table border="1"> <thead> <tr> <th>Code</th> <th>Description</th> <th>Qty</th> <th>UOM</th> </tr> </thead> <tbody> <tr> <td>EL1440A0</td> <td>ELETTROVALV OLA H2O AUTOPULENT E BAF EU</td> <td>4.000</td> <td>PZ</td> </tr> <tr> <td>GN1526A0</td> <td>O-RING D.INT6.9 SP1.8</td> <td>9.000</td> <td>PZ</td> </tr> <tr> <td>RC1018A0</td> <td>FASCETTA ELASTICA D12 ZINCATA</td> <td>11.000</td> <td>PZ</td> </tr> <tr> <td>RC1019A0</td> <td>FASCETTA ELASTICA D10 ZINCATA</td> <td>14.000</td> <td>PZ</td> </tr> <tr> <td>RC1130A0</td> <td>FASCETTA 130X2,6</td> <td>1.000</td> <td>PZ</td> </tr> <tr> <td>RC1131A0</td> <td>FASCETTA 200X2,6 BIANC</td> <td>3.000</td> <td>PZ</td> </tr> <tr> <td>RC1242A0</td> <td>TERMINALE CHIUSO D10</td> <td>2.000</td> <td>PZ</td> </tr> <tr> <td>RC1356A0</td> <td>RACCORDO DRITTO FIL. FEMM 8X1/4 BSP</td> <td>1.000</td> <td>PZ</td> </tr> <tr> <td>RC1414A1</td> <td>FASCETTA STRINGITUBO A SCATTO D11.5-12.5</td> <td>1.000</td> <td>PZ</td> </tr> <tr> <td>TB2652A0</td> <td>TB3132A-L750 MM BIANCO BLU EPDM</td> <td>1.000</td> <td>PZ</td> </tr> <tr> <td>TB2677A0</td> <td>TB2820A-TUB O TANICA DET-FDET L1300MM</td> <td>1.000</td> <td>PZ</td> </tr> <tr> <td>TB2821A0</td> <td>TB2820A-L=40 MM EPDM NER</td> <td>4.000</td> <td>PZ</td> </tr> <tr> <td>TB3004A0</td> <td>TB2820A-L=57 0MM EPDM NERO</td> <td>2.000</td> <td>PZ</td> </tr> <tr> <td>TB3024C0</td> <td>TB3132A-TUB O BLU 6X12 L=55MM</td> <td>3.000</td> <td>PZ</td> </tr> <tr> <td>TB3226A0</td> <td>TB2820A-L110 MM COLLEGAMEN TO TANICA-LA</td> <td>1.000</td> <td>PZ</td> </tr> <tr> <td>TB3440A0</td> <td>TB3132A-L=10 50MM EPDM BIANCO-BLU</td> <td>1.000</td> <td>PZ</td> </tr> <tr> <td>TB3614A0</td> <td>TB2820A-L=96 MM NERO EPD</td> <td>1.000</td> <td>PZ</td> </tr> <tr> <td>VI1220A1</td> <td>VITE AUTOFIL. 4.2X11 TCS+ MARUTEX</td> <td>1.000</td> <td>PZ</td> </tr> </tbody> </table>	Code	Description	Qty	UOM	EL1440A0	ELETTROVALV OLA H2O AUTOPULENT E BAF EU	4.000	PZ	GN1526A0	O-RING D.INT6.9 SP1.8	9.000	PZ	RC1018A0	FASCETTA ELASTICA D12 ZINCATA	11.000	PZ	RC1019A0	FASCETTA ELASTICA D10 ZINCATA	14.000	PZ	RC1130A0	FASCETTA 130X2,6	1.000	PZ	RC1131A0	FASCETTA 200X2,6 BIANC	3.000	PZ	RC1242A0	TERMINALE CHIUSO D10	2.000	PZ	RC1356A0	RACCORDO DRITTO FIL. FEMM 8X1/4 BSP	1.000	PZ	RC1414A1	FASCETTA STRINGITUBO A SCATTO D11.5-12.5	1.000	PZ	TB2652A0	TB3132A-L750 MM BIANCO BLU EPDM	1.000	PZ	TB2677A0	TB2820A-TUB O TANICA DET-FDET L1300MM	1.000	PZ	TB2821A0	TB2820A-L=40 MM EPDM NER	4.000	PZ	TB3004A0	TB2820A-L=57 0MM EPDM NERO	2.000	PZ	TB3024C0	TB3132A-TUB O BLU 6X12 L=55MM	3.000	PZ	TB3226A0	TB2820A-L110 MM COLLEGAMEN TO TANICA-LA	1.000	PZ	TB3440A0	TB3132A-L=10 50MM EPDM BIANCO-BLU	1.000	PZ	TB3614A0	TB2820A-L=96 MM NERO EPD	1.000	PZ	VI1220A1	VITE AUTOFIL. 4.2X11 TCS+ MARUTEX	1.000	PZ
Code	Description	Qty	UOM																																																																														
EL1440A0	ELETTROVALV OLA H2O AUTOPULENT E BAF EU	4.000	PZ																																																																														
GN1526A0	O-RING D.INT6.9 SP1.8	9.000	PZ																																																																														
RC1018A0	FASCETTA ELASTICA D12 ZINCATA	11.000	PZ																																																																														
RC1019A0	FASCETTA ELASTICA D10 ZINCATA	14.000	PZ																																																																														
RC1130A0	FASCETTA 130X2,6	1.000	PZ																																																																														
RC1131A0	FASCETTA 200X2,6 BIANC	3.000	PZ																																																																														
RC1242A0	TERMINALE CHIUSO D10	2.000	PZ																																																																														
RC1356A0	RACCORDO DRITTO FIL. FEMM 8X1/4 BSP	1.000	PZ																																																																														
RC1414A1	FASCETTA STRINGITUBO A SCATTO D11.5-12.5	1.000	PZ																																																																														
TB2652A0	TB3132A-L750 MM BIANCO BLU EPDM	1.000	PZ																																																																														
TB2677A0	TB2820A-TUB O TANICA DET-FDET L1300MM	1.000	PZ																																																																														
TB2821A0	TB2820A-L=40 MM EPDM NER	4.000	PZ																																																																														
TB3004A0	TB2820A-L=57 0MM EPDM NERO	2.000	PZ																																																																														
TB3024C0	TB3132A-TUB O BLU 6X12 L=55MM	3.000	PZ																																																																														
TB3226A0	TB2820A-L110 MM COLLEGAMEN TO TANICA-LA	1.000	PZ																																																																														
TB3440A0	TB3132A-L=10 50MM EPDM BIANCO-BLU	1.000	PZ																																																																														
TB3614A0	TB2820A-L=96 MM NERO EPD	1.000	PZ																																																																														
VI1220A1	VITE AUTOFIL. 4.2X11 TCS+ MARUTEX	1.000	PZ																																																																														



COMPONENT			SPARE PART																																																																													
Code	Description	Image	Code	Description	Kit components																																																																											
VL1190A	DISTRIBUTORE INGRESSI LAVAGGIO PLUS		KVL1187A	3 ROTOR ARMS PLUS EU CLEANING SYSTEM KIT	<table border="1"> <thead> <tr> <th>Code</th> <th>Description</th> <th>Qty</th> <th>UOM</th> </tr> </thead> <tbody> <tr> <td>VL1019A0</td> <td>POMPA DETERGENTE VIBRAZIONE</td> <td>1.000</td> <td>PZ</td> </tr> <tr> <td>VL1047A1</td> <td>PORTAGOMM A D6 CODOLO D8</td> <td>1.000</td> <td>PZ</td> </tr> <tr> <td>VL1102A1</td> <td>FILTRO IN LINEA DET. + VNR BARBED 6 MM</td> <td>1.000</td> <td>PZ</td> </tr> <tr> <td>VL1127A1</td> <td>RACCORDO A T BARBED 6</td> <td>2.000</td> <td>PZ</td> </tr> <tr> <td>VL1128A1</td> <td>VALVOLA VNR BARBED D6</td> <td>2.000</td> <td>PZ</td> </tr> <tr> <td>VL1166A0</td> <td>RACCORDO A L BAM-BB6</td> <td>4.000</td> <td>PZ</td> </tr> <tr> <td>VL1167A2</td> <td>FLOW RESTRICTOR 3 GIRANTI GN21 B-B</td> <td>1.000</td> <td>PZ</td> </tr> <tr> <td>VL1174C0</td> <td>UGELLO CALIBRATO D1.2 MM</td> <td>1.000</td> <td>PZ</td> </tr> <tr> <td>VL1186A0</td> <td>DISTRIBUTOR E LAVAGGIO PLUS 3 VIE UGELLO</td> <td>1.000</td> <td>PZ</td> </tr> <tr> <td>VL1190A0</td> <td>DISTRIBUTOR E INGRESSI LAVAGGIO PLUS</td> <td>1.000</td> <td>PZ</td> </tr> <tr> <td>VL1214A0</td> <td>VALVOLA VNR BB6-BAIONET TA</td> <td>1.000</td> <td>PZ</td> </tr> <tr> <td>VL1398A0</td> <td>PRESSOSTAT O N.O. 1/4 M CI</td> <td>1.000</td> <td>PZ</td> </tr> <tr> <td>VM1605A0</td> <td>CLIP TWIST LOCK DIAM. 10.2-12.7 MM</td> <td>3.000</td> <td>PZ</td> </tr> <tr> <td>VM2172A0</td> <td>CLIP BLOCCAGGIO POMPA CON CIRCUITO</td> <td>5.000</td> <td>PZ</td> </tr> </tbody> </table>	Code	Description	Qty	UOM	VL1019A0	POMPA DETERGENTE VIBRAZIONE	1.000	PZ	VL1047A1	PORTAGOMM A D6 CODOLO D8	1.000	PZ	VL1102A1	FILTRO IN LINEA DET. + VNR BARBED 6 MM	1.000	PZ	VL1127A1	RACCORDO A T BARBED 6	2.000	PZ	VL1128A1	VALVOLA VNR BARBED D6	2.000	PZ	VL1166A0	RACCORDO A L BAM-BB6	4.000	PZ	VL1167A2	FLOW RESTRICTOR 3 GIRANTI GN21 B-B	1.000	PZ	VL1174C0	UGELLO CALIBRATO D1.2 MM	1.000	PZ	VL1186A0	DISTRIBUTOR E LAVAGGIO PLUS 3 VIE UGELLO	1.000	PZ	VL1190A0	DISTRIBUTOR E INGRESSI LAVAGGIO PLUS	1.000	PZ	VL1214A0	VALVOLA VNR BB6-BAIONET TA	1.000	PZ	VL1398A0	PRESSOSTAT O N.O. 1/4 M CI	1.000	PZ	VM1605A0	CLIP TWIST LOCK DIAM. 10.2-12.7 MM	3.000	PZ	VM2172A0	CLIP BLOCCAGGIO POMPA CON CIRCUITO	5.000	PZ	KVL1184A	2 ROTOR ARMS PLUS EU CLEANING SYSTEM KIT	<table border="1"> <thead> <tr> <th>Code</th> <th>Description</th> <th>Qty</th> <th>UOM</th> </tr> </thead> <tbody> <tr> <td>0H2354A2</td> <td>LAMIERA IMPIANTO LAVAGGIO PLUS XEVC-XEVL</td> <td>1.000</td> <td>PZ</td> </tr> <tr> <td>EL1346A0</td> <td>CLIP BLOCCA PINZETTA RACCORDI D10 TIERRE</td> <td>2.000</td> <td>PZ</td> </tr> </tbody> </table>	Code	Description	Qty	UOM	0H2354A2	LAMIERA IMPIANTO LAVAGGIO PLUS XEVC-XEVL	1.000	PZ	EL1346A0	CLIP BLOCCA PINZETTA RACCORDI D10 TIERRE	2.000	PZ
			Code	Description	Qty	UOM																																																																										
VL1019A0	POMPA DETERGENTE VIBRAZIONE	1.000	PZ																																																																													
VL1047A1	PORTAGOMM A D6 CODOLO D8	1.000	PZ																																																																													
VL1102A1	FILTRO IN LINEA DET. + VNR BARBED 6 MM	1.000	PZ																																																																													
VL1127A1	RACCORDO A T BARBED 6	2.000	PZ																																																																													
VL1128A1	VALVOLA VNR BARBED D6	2.000	PZ																																																																													
VL1166A0	RACCORDO A L BAM-BB6	4.000	PZ																																																																													
VL1167A2	FLOW RESTRICTOR 3 GIRANTI GN21 B-B	1.000	PZ																																																																													
VL1174C0	UGELLO CALIBRATO D1.2 MM	1.000	PZ																																																																													
VL1186A0	DISTRIBUTOR E LAVAGGIO PLUS 3 VIE UGELLO	1.000	PZ																																																																													
VL1190A0	DISTRIBUTOR E INGRESSI LAVAGGIO PLUS	1.000	PZ																																																																													
VL1214A0	VALVOLA VNR BB6-BAIONET TA	1.000	PZ																																																																													
VL1398A0	PRESSOSTAT O N.O. 1/4 M CI	1.000	PZ																																																																													
VM1605A0	CLIP TWIST LOCK DIAM. 10.2-12.7 MM	3.000	PZ																																																																													
VM2172A0	CLIP BLOCCAGGIO POMPA CON CIRCUITO	5.000	PZ																																																																													
Code	Description	Qty	UOM																																																																													
0H2354A2	LAMIERA IMPIANTO LAVAGGIO PLUS XEVC-XEVL	1.000	PZ																																																																													
EL1346A0	CLIP BLOCCA PINZETTA RACCORDI D10 TIERRE	2.000	PZ																																																																													



COMPONENT			SPARE PART																																																																																		
Code	Description	Image	Code	Description	Kit components																																																																																
VL1190A	DISTRIBUTORE INGRESSI LAVAGGIO PLUS		KVL1184A	2 ROTOR ARMS PLUS EU CLEANING SYSTEM KIT	<table border="1"> <thead> <tr> <th>Code</th> <th>Description</th> <th>Qty</th> <th>UOM</th> </tr> </thead> <tbody> <tr> <td>EL1440A0</td> <td>ELETTROVALV OLA H2O AUTOPULENT E BAF EU</td> <td>4.000</td> <td>PZ</td> </tr> <tr> <td>GN1526A0</td> <td>O-RING D.INT6.9 SP1.8</td> <td>9.000</td> <td>PZ</td> </tr> <tr> <td>RC1018A0</td> <td>FASCETTA ELASTICA D12 ZINCATA</td> <td>2.000</td> <td>PZ</td> </tr> <tr> <td>RC1019A0</td> <td>FASCETTA ELASTICA D10 ZINCATA</td> <td>13.000</td> <td>PZ</td> </tr> <tr> <td>RC1130A0</td> <td>FASCETTA 130X2,6</td> <td>1.000</td> <td>PZ</td> </tr> <tr> <td>RC1131A0</td> <td>FASCETTA 200X2,6 BIANC</td> <td>3.000</td> <td>PZ</td> </tr> <tr> <td>RC1242A0</td> <td>TERMINALE CHIUSO D10</td> <td>2.000</td> <td>PZ</td> </tr> <tr> <td>RC1356A0</td> <td>RACCORDO DRITTO FIL. FEMM 8X1/4 BSP</td> <td>1.000</td> <td>PZ</td> </tr> <tr> <td>RC1414A1</td> <td>FASCETTA STRINGITUBO A SCATTO D11.5-12.5</td> <td>1.000</td> <td>PZ</td> </tr> <tr> <td>TB2821A0</td> <td>TB2820A-L=40 MM EPDM NER</td> <td>4.000</td> <td>PZ</td> </tr> <tr> <td>TB2994A0</td> <td>TB2820A-TUB O EPDM NERO 1000MM</td> <td>1.000</td> <td>PZ</td> </tr> <tr> <td>TB3004A0</td> <td>TB2820A-L=57 0MM EPDM NERO</td> <td>2.000</td> <td>PZ</td> </tr> <tr> <td>TB3005B0</td> <td>TB3132A-L=55 0MM EPDM BIANCO BLU</td> <td>1.000</td> <td>PZ</td> </tr> <tr> <td>TB3440A0</td> <td>TB3132A-L=10 50MM EPDM BIANCO-BLU</td> <td>1.000</td> <td>PZ</td> </tr> <tr> <td>TB3614A0</td> <td>TB2820A-L=96 MM NERO EPD</td> <td>1.000</td> <td>PZ</td> </tr> <tr> <td>VI1220A1</td> <td>VITE AUTOFIL. 4.2X11 TCS+ MARUTEX</td> <td>1.000</td> <td>PZ</td> </tr> <tr> <td>VL1019A0</td> <td>POMPA DETERGENTE VIBRAZIONE</td> <td>1.000</td> <td>PZ</td> </tr> <tr> <td>VL1047A1</td> <td>PORTAGOMM A D6 CODOLO D8</td> <td>1.000</td> <td>PZ</td> </tr> <tr> <td>VL1102A1</td> <td>FILTRO IN LINEA DET. + VNR BARBED 6 MM</td> <td>1.000</td> <td>PZ</td> </tr> </tbody> </table>	Code	Description	Qty	UOM	EL1440A0	ELETTROVALV OLA H2O AUTOPULENT E BAF EU	4.000	PZ	GN1526A0	O-RING D.INT6.9 SP1.8	9.000	PZ	RC1018A0	FASCETTA ELASTICA D12 ZINCATA	2.000	PZ	RC1019A0	FASCETTA ELASTICA D10 ZINCATA	13.000	PZ	RC1130A0	FASCETTA 130X2,6	1.000	PZ	RC1131A0	FASCETTA 200X2,6 BIANC	3.000	PZ	RC1242A0	TERMINALE CHIUSO D10	2.000	PZ	RC1356A0	RACCORDO DRITTO FIL. FEMM 8X1/4 BSP	1.000	PZ	RC1414A1	FASCETTA STRINGITUBO A SCATTO D11.5-12.5	1.000	PZ	TB2821A0	TB2820A-L=40 MM EPDM NER	4.000	PZ	TB2994A0	TB2820A-TUB O EPDM NERO 1000MM	1.000	PZ	TB3004A0	TB2820A-L=57 0MM EPDM NERO	2.000	PZ	TB3005B0	TB3132A-L=55 0MM EPDM BIANCO BLU	1.000	PZ	TB3440A0	TB3132A-L=10 50MM EPDM BIANCO-BLU	1.000	PZ	TB3614A0	TB2820A-L=96 MM NERO EPD	1.000	PZ	VI1220A1	VITE AUTOFIL. 4.2X11 TCS+ MARUTEX	1.000	PZ	VL1019A0	POMPA DETERGENTE VIBRAZIONE	1.000	PZ	VL1047A1	PORTAGOMM A D6 CODOLO D8	1.000	PZ	VL1102A1	FILTRO IN LINEA DET. + VNR BARBED 6 MM	1.000	PZ
Code	Description	Qty	UOM																																																																																		
EL1440A0	ELETTROVALV OLA H2O AUTOPULENT E BAF EU	4.000	PZ																																																																																		
GN1526A0	O-RING D.INT6.9 SP1.8	9.000	PZ																																																																																		
RC1018A0	FASCETTA ELASTICA D12 ZINCATA	2.000	PZ																																																																																		
RC1019A0	FASCETTA ELASTICA D10 ZINCATA	13.000	PZ																																																																																		
RC1130A0	FASCETTA 130X2,6	1.000	PZ																																																																																		
RC1131A0	FASCETTA 200X2,6 BIANC	3.000	PZ																																																																																		
RC1242A0	TERMINALE CHIUSO D10	2.000	PZ																																																																																		
RC1356A0	RACCORDO DRITTO FIL. FEMM 8X1/4 BSP	1.000	PZ																																																																																		
RC1414A1	FASCETTA STRINGITUBO A SCATTO D11.5-12.5	1.000	PZ																																																																																		
TB2821A0	TB2820A-L=40 MM EPDM NER	4.000	PZ																																																																																		
TB2994A0	TB2820A-TUB O EPDM NERO 1000MM	1.000	PZ																																																																																		
TB3004A0	TB2820A-L=57 0MM EPDM NERO	2.000	PZ																																																																																		
TB3005B0	TB3132A-L=55 0MM EPDM BIANCO BLU	1.000	PZ																																																																																		
TB3440A0	TB3132A-L=10 50MM EPDM BIANCO-BLU	1.000	PZ																																																																																		
TB3614A0	TB2820A-L=96 MM NERO EPD	1.000	PZ																																																																																		
VI1220A1	VITE AUTOFIL. 4.2X11 TCS+ MARUTEX	1.000	PZ																																																																																		
VL1019A0	POMPA DETERGENTE VIBRAZIONE	1.000	PZ																																																																																		
VL1047A1	PORTAGOMM A D6 CODOLO D8	1.000	PZ																																																																																		
VL1102A1	FILTRO IN LINEA DET. + VNR BARBED 6 MM	1.000	PZ																																																																																		

COMPONENT			SPARE PART																																										
Code	Description	Image	Code	Description	Kit components																																								
VL1190A	DISTRIBUTORE INGRESSI LAVAGGIO PLUS		KVL1184A	2 ROTOR ARMS PLUS EU CLEANING SYSTEM KIT	<table border="1"> <thead> <tr> <th>Code</th> <th>Description</th> <th>Qty</th> <th>UOM</th> </tr> </thead> <tbody> <tr> <td>VL1128A1</td> <td>VALVOLA VNR BARBED D6</td> <td>1.000</td> <td>PZ</td> </tr> <tr> <td>VL1166A0</td> <td>RACCORDO A L BAMB-BB6</td> <td>4.000</td> <td>PZ</td> </tr> <tr> <td>VL1174C0</td> <td>UGELLO CALIBRATO D1.2 MM</td> <td>1.000</td> <td>PZ</td> </tr> <tr> <td>VL1186A0</td> <td>DISTRIBUTOR E LAVAGGIO PLUS 3 VIE UGELLO</td> <td>1.000</td> <td>PZ</td> </tr> <tr> <td>VL1190A0</td> <td>DISTRIBUTOR E INGRESSI LAVAGGIO PLUS</td> <td>1.000</td> <td>PZ</td> </tr> <tr> <td>VL1214A0</td> <td>VALVOLA VNR BB6-BAIONET TA</td> <td>1.000</td> <td>PZ</td> </tr> <tr> <td>VL1398A0</td> <td>PRESSOSTAT O.N.O. 1/4 M CI</td> <td>1.000</td> <td>PZ</td> </tr> <tr> <td>VM1605A0</td> <td>CLIP TWIST LOCK DIAM. 10,2-12,7 MM</td> <td>3.000</td> <td>PZ</td> </tr> <tr> <td>VM2172A0</td> <td>CLIP BLOCCAGGIO POMPA CON CIRCUITO</td> <td>5.000</td> <td>PZ</td> </tr> </tbody> </table>	Code	Description	Qty	UOM	VL1128A1	VALVOLA VNR BARBED D6	1.000	PZ	VL1166A0	RACCORDO A L BAMB-BB6	4.000	PZ	VL1174C0	UGELLO CALIBRATO D1.2 MM	1.000	PZ	VL1186A0	DISTRIBUTOR E LAVAGGIO PLUS 3 VIE UGELLO	1.000	PZ	VL1190A0	DISTRIBUTOR E INGRESSI LAVAGGIO PLUS	1.000	PZ	VL1214A0	VALVOLA VNR BB6-BAIONET TA	1.000	PZ	VL1398A0	PRESSOSTAT O.N.O. 1/4 M CI	1.000	PZ	VM1605A0	CLIP TWIST LOCK DIAM. 10,2-12,7 MM	3.000	PZ	VM2172A0	CLIP BLOCCAGGIO POMPA CON CIRCUITO	5.000	PZ
			Code	Description	Qty	UOM																																							
VL1128A1	VALVOLA VNR BARBED D6	1.000	PZ																																										
VL1166A0	RACCORDO A L BAMB-BB6	4.000	PZ																																										
VL1174C0	UGELLO CALIBRATO D1.2 MM	1.000	PZ																																										
VL1186A0	DISTRIBUTOR E LAVAGGIO PLUS 3 VIE UGELLO	1.000	PZ																																										
VL1190A0	DISTRIBUTOR E INGRESSI LAVAGGIO PLUS	1.000	PZ																																										
VL1214A0	VALVOLA VNR BB6-BAIONET TA	1.000	PZ																																										
VL1398A0	PRESSOSTAT O.N.O. 1/4 M CI	1.000	PZ																																										
VM1605A0	CLIP TWIST LOCK DIAM. 10,2-12,7 MM	3.000	PZ																																										
VM2172A0	CLIP BLOCCAGGIO POMPA CON CIRCUITO	5.000	PZ																																										
KVL1183A	1 ROTOR ARM PLUS CLEANING SYSTEM KIT	<table border="1"> <thead> <tr> <th>Code</th> <th>Description</th> <th>Qty</th> <th>UOM</th> </tr> </thead> <tbody> <tr> <td>0H2354A2</td> <td>LAMIERA IMPIANTO LAVAGGIO PLUS XEVC-XEVL</td> <td>1.000</td> <td>PZ</td> </tr> <tr> <td>EL1346A0</td> <td>CLIP BLOCCA PINZETTA RACCORDI D10 TIERRE</td> <td>2.000</td> <td>PZ</td> </tr> <tr> <td>EL1440A0</td> <td>ELETTROVALV OLA H2O AUTOPULENT E BAF EU</td> <td>3.000</td> <td>PZ</td> </tr> <tr> <td>GN1526A0</td> <td>O-RING D.INT6.9 SP1.8</td> <td>7.000</td> <td>PZ</td> </tr> <tr> <td>RC1018A0</td> <td>FASCETTA ELASTICA D12 ZINCATA</td> <td>1.000</td> <td>PZ</td> </tr> <tr> <td>RC1019A0</td> <td>FASCETTA ELASTICA D10 ZINCATA</td> <td>12.000</td> <td>PZ</td> </tr> <tr> <td>RC1130A0</td> <td>FASCETTA 130X2,6</td> <td>1.000</td> <td>PZ</td> </tr> <tr> <td>RC1131A0</td> <td>FASCETTA 200X2,6 BIANC</td> <td>2.000</td> <td>PZ</td> </tr> </tbody> </table>	Code	Description	Qty	UOM	0H2354A2	LAMIERA IMPIANTO LAVAGGIO PLUS XEVC-XEVL	1.000	PZ	EL1346A0	CLIP BLOCCA PINZETTA RACCORDI D10 TIERRE	2.000	PZ	EL1440A0	ELETTROVALV OLA H2O AUTOPULENT E BAF EU	3.000	PZ	GN1526A0	O-RING D.INT6.9 SP1.8	7.000	PZ	RC1018A0	FASCETTA ELASTICA D12 ZINCATA	1.000	PZ	RC1019A0	FASCETTA ELASTICA D10 ZINCATA	12.000	PZ	RC1130A0	FASCETTA 130X2,6	1.000	PZ	RC1131A0	FASCETTA 200X2,6 BIANC	2.000	PZ							
Code	Description	Qty	UOM																																										
0H2354A2	LAMIERA IMPIANTO LAVAGGIO PLUS XEVC-XEVL	1.000	PZ																																										
EL1346A0	CLIP BLOCCA PINZETTA RACCORDI D10 TIERRE	2.000	PZ																																										
EL1440A0	ELETTROVALV OLA H2O AUTOPULENT E BAF EU	3.000	PZ																																										
GN1526A0	O-RING D.INT6.9 SP1.8	7.000	PZ																																										
RC1018A0	FASCETTA ELASTICA D12 ZINCATA	1.000	PZ																																										
RC1019A0	FASCETTA ELASTICA D10 ZINCATA	12.000	PZ																																										
RC1130A0	FASCETTA 130X2,6	1.000	PZ																																										
RC1131A0	FASCETTA 200X2,6 BIANC	2.000	PZ																																										

COMPONENT			SPARE PART					
Code	Description	Image	Code	Description	Kit components			
VL1190A	DISTRIBUTORE INGRESSI LAVAGGIO PLUS		KVL1183A	1 ROTOR ARM PLUS CLEANING SYSTEM KIT	Code	Description	Qty	UOM
					RC1242A0	TERMINALE CHIUSO D10	2.000	PZ
					RC1356A0	RACCORDO DRITTO FIL. FEMM 8X1/4 BSP	1.000	PZ
					RC1414A1	FASCETTA STRINGITUBO A SCATTO D11.5-12.5	4.000	PZ
					TB2821A0	TB2820A-L=40 MM EPDM NER	4.000	PZ
					TB3004A0	TB2820A-L=57 0MM EPDM NERO	1.000	PZ
					TB3252A0	TB3132A-L=23 0MM EPDM BIANCO BLU	1.000	PZ
					TB3614A0	TB2820A-L=96 MM NERO EPD	1.000	PZ
					TB5360A0	TB3132A-TUB O EPDM TELATO BIANCO-BLU 550M	1.000	PZ
					TB5362A0	TB3132A-TUB O EPDM TELATO BIANCO-BLU 230M	1.000	PZ
					VI1220A1	VITE AUTOFIL. 4.2X11 TCS+ MARUTEX	1.000	PZ
					VL1019A0	POMPA DETERGENTE VIBRAZIONE	1.000	PZ
					VL1047A1	PORTAGOMM A D6 CODOLO D8	1.000	PZ
					VL1102A1	FILTRO IN LINEA DET. + VNR BARBED 6 MM	1.000	PZ
					VL1128A1	VALVOLA VNR BARBED D6	1.000	PZ
					VL1166A0	RACCORDO A L BAM-BB6	3.000	PZ
					VL1174C0	UGELLO CALIBRATO D1.2 MM	1.000	PZ
					VL1185A0	DISTRIBUTOR E LAVAGGIO PLUS 2 VIE UGELLO	1.000	PZ

COMPONENT			SPARE PART																																																										
Code	Description	Image	Code	Description	Kit components																																																								
VL1190A	DISTRIBUTORE INGRESSI LAVAGGIO PLUS		KVL1183A	1 ROTOR ARM PLUS CLEANING SYSTEM KIT	<table border="1"> <thead> <tr> <th>Code</th> <th>Description</th> <th>Qty</th> <th>UOM</th> </tr> </thead> <tbody> <tr> <td>VL1190A0</td> <td>DISTRIBUTOR E INGRESSI LAVAGGIO PLUS</td> <td>1.000</td> <td>PZ</td> </tr> <tr> <td>VL1214A0</td> <td>VALVOLA VNR BB6-BAIONET TA</td> <td>1.000</td> <td>PZ</td> </tr> <tr> <td>VL1398A0</td> <td>PRESSOSTAT O.N.O. 1/4 M CI</td> <td>1.000</td> <td>PZ</td> </tr> <tr> <td>VM1605A0</td> <td>CLIP TWIST LOCK DIAM. 10,2-12,7 MM</td> <td>3.000</td> <td>PZ</td> </tr> <tr> <td>VM2172A0</td> <td>CLIP BLOCCAGGIO POMPA CON CIRCUITO</td> <td>4.000</td> <td>PZ</td> </tr> </tbody> </table>	Code	Description	Qty	UOM	VL1190A0	DISTRIBUTOR E INGRESSI LAVAGGIO PLUS	1.000	PZ	VL1214A0	VALVOLA VNR BB6-BAIONET TA	1.000	PZ	VL1398A0	PRESSOSTAT O.N.O. 1/4 M CI	1.000	PZ	VM1605A0	CLIP TWIST LOCK DIAM. 10,2-12,7 MM	3.000	PZ	VM2172A0	CLIP BLOCCAGGIO POMPA CON CIRCUITO	4.000	PZ																																
Code	Description	Qty	UOM																																																										
VL1190A0	DISTRIBUTOR E INGRESSI LAVAGGIO PLUS	1.000	PZ																																																										
VL1214A0	VALVOLA VNR BB6-BAIONET TA	1.000	PZ																																																										
VL1398A0	PRESSOSTAT O.N.O. 1/4 M CI	1.000	PZ																																																										
VM1605A0	CLIP TWIST LOCK DIAM. 10,2-12,7 MM	3.000	PZ																																																										
VM2172A0	CLIP BLOCCAGGIO POMPA CON CIRCUITO	4.000	PZ																																																										
			KVL0684A	>12/2019 2-3ROTOR ARM PLUS WASH PUMP KIT	<table border="1"> <thead> <tr> <th>Code</th> <th>Description</th> <th>Qty</th> <th>UOM</th> </tr> </thead> <tbody> <tr> <td>EL1346A0</td> <td>CLIP BLOCCA PINZETTA RACCORDI D10 TIERRE</td> <td>2.000</td> <td>PZ</td> </tr> <tr> <td>GN1526A0</td> <td>O-RING D.INT6,9 SP1.8</td> <td>3.000</td> <td>PZ</td> </tr> <tr> <td>RC1019A0</td> <td>FASCETTA ELASTICA D10 ZINCATA</td> <td>4.000</td> <td>PZ</td> </tr> <tr> <td>RC1130A0</td> <td>FASCETTA 130X2,6</td> <td>1.000</td> <td>PZ</td> </tr> <tr> <td>RC1131A0</td> <td>FASCETTA 200X2,6 BIANC</td> <td>3.000</td> <td>PZ</td> </tr> <tr> <td>RC1242A0</td> <td>TERMINALE CHIUSO D10</td> <td>2.000</td> <td>PZ</td> </tr> <tr> <td>TB2821A0</td> <td>TB2820A-L=40 MM EPDM NER</td> <td>3.000</td> <td>PZ</td> </tr> <tr> <td>VL1019A0</td> <td>POMPA DETERGENTE VIBRAZIONE</td> <td>1.000</td> <td>PZ</td> </tr> <tr> <td>VL1128A1</td> <td>VALVOLA VNR BARBED D6</td> <td>1.000</td> <td>PZ</td> </tr> <tr> <td>VL1174C0</td> <td>UGELLO CALIBRATO D1.2 MM</td> <td>1.000</td> <td>PZ</td> </tr> <tr> <td>VL1186A0</td> <td>DISTRIBUTOR E LAVAGGIO PLUS 3 VIE UGELLO</td> <td>1.000</td> <td>PZ</td> </tr> <tr> <td>VL1190A0</td> <td>DISTRIBUTOR E INGRESSI LAVAGGIO PLUS</td> <td>1.000</td> <td>PZ</td> </tr> <tr> <td>VM2172A0</td> <td>CLIP BLOCCAGGIO POMPA CON CIRCUITO</td> <td>1.000</td> <td>PZ</td> </tr> </tbody> </table>	Code	Description	Qty	UOM	EL1346A0	CLIP BLOCCA PINZETTA RACCORDI D10 TIERRE	2.000	PZ	GN1526A0	O-RING D.INT6,9 SP1.8	3.000	PZ	RC1019A0	FASCETTA ELASTICA D10 ZINCATA	4.000	PZ	RC1130A0	FASCETTA 130X2,6	1.000	PZ	RC1131A0	FASCETTA 200X2,6 BIANC	3.000	PZ	RC1242A0	TERMINALE CHIUSO D10	2.000	PZ	TB2821A0	TB2820A-L=40 MM EPDM NER	3.000	PZ	VL1019A0	POMPA DETERGENTE VIBRAZIONE	1.000	PZ	VL1128A1	VALVOLA VNR BARBED D6	1.000	PZ	VL1174C0	UGELLO CALIBRATO D1.2 MM	1.000	PZ	VL1186A0	DISTRIBUTOR E LAVAGGIO PLUS 3 VIE UGELLO	1.000	PZ	VL1190A0	DISTRIBUTOR E INGRESSI LAVAGGIO PLUS	1.000	PZ	VM2172A0	CLIP BLOCCAGGIO POMPA CON CIRCUITO	1.000	PZ
Code	Description	Qty	UOM																																																										
EL1346A0	CLIP BLOCCA PINZETTA RACCORDI D10 TIERRE	2.000	PZ																																																										
GN1526A0	O-RING D.INT6,9 SP1.8	3.000	PZ																																																										
RC1019A0	FASCETTA ELASTICA D10 ZINCATA	4.000	PZ																																																										
RC1130A0	FASCETTA 130X2,6	1.000	PZ																																																										
RC1131A0	FASCETTA 200X2,6 BIANC	3.000	PZ																																																										
RC1242A0	TERMINALE CHIUSO D10	2.000	PZ																																																										
TB2821A0	TB2820A-L=40 MM EPDM NER	3.000	PZ																																																										
VL1019A0	POMPA DETERGENTE VIBRAZIONE	1.000	PZ																																																										
VL1128A1	VALVOLA VNR BARBED D6	1.000	PZ																																																										
VL1174C0	UGELLO CALIBRATO D1.2 MM	1.000	PZ																																																										
VL1186A0	DISTRIBUTOR E LAVAGGIO PLUS 3 VIE UGELLO	1.000	PZ																																																										
VL1190A0	DISTRIBUTOR E INGRESSI LAVAGGIO PLUS	1.000	PZ																																																										
VM2172A0	CLIP BLOCCAGGIO POMPA CON CIRCUITO	1.000	PZ																																																										

COMPONENT			SPARE PART																																																										
Code	Description	Image	Code	Description	Kit components																																																								
VL1190A	DISTRIBUTORE INGRESSI LAVAGGIO PLUS		KVL0683A	>12/2019 1 ROTOR ARM PLUS WASH PUMP KIT	<table border="1"> <thead> <tr> <th>Code</th> <th>Description</th> <th>Qty</th> <th>UOM</th> </tr> </thead> <tbody> <tr> <td>EL1346A0</td> <td>CLIP BLOCCA PINZETTA RACCORDI D10 TIERRE</td> <td>2.000</td> <td>PZ</td> </tr> <tr> <td>GN1526A0</td> <td>O-RING D.INT6,9 SP1.8</td> <td>1.000</td> <td>PZ</td> </tr> <tr> <td>RC1019A0</td> <td>FASCETTA ELASTICA D10 ZINCATA</td> <td>4.000</td> <td>PZ</td> </tr> <tr> <td>RC1130A0</td> <td>FASCETTA 130X2,6</td> <td>1.000</td> <td>PZ</td> </tr> <tr> <td>RC1131A0</td> <td>FASCETTA 200X2,6 BIANC</td> <td>2.000</td> <td>PZ</td> </tr> <tr> <td>RC1242A0</td> <td>TERMINALE CHIUSO D10</td> <td>2.000</td> <td>PZ</td> </tr> <tr> <td>TB2821A0</td> <td>TB2820A-L=40 MM EPDM NER</td> <td>3.000</td> <td>PZ</td> </tr> <tr> <td>VL1019A0</td> <td>POMPA DETERGENTE VIBRAZIONE</td> <td>1.000</td> <td>PZ</td> </tr> <tr> <td>VL1128A1</td> <td>VALVOLA VNR BARBED D6</td> <td>1.000</td> <td>PZ</td> </tr> <tr> <td>VL1174C0</td> <td>UGELLO CALIBRATO D1.2 MM</td> <td>1.000</td> <td>PZ</td> </tr> <tr> <td>VL1185A0</td> <td>DISTRIBUTOR E LAVAGGIO PLUS 2 VIE UGELLO</td> <td>1.000</td> <td>PZ</td> </tr> <tr> <td>VL1190A0</td> <td>DISTRIBUTOR E INGRESSI LAVAGGIO PLUS</td> <td>1.000</td> <td>PZ</td> </tr> <tr> <td>VM2172A0</td> <td>CLIP BLOCCAGGIO POMPA CON CIRCUITO</td> <td>1.000</td> <td>PZ</td> </tr> </tbody> </table>	Code	Description	Qty	UOM	EL1346A0	CLIP BLOCCA PINZETTA RACCORDI D10 TIERRE	2.000	PZ	GN1526A0	O-RING D.INT6,9 SP1.8	1.000	PZ	RC1019A0	FASCETTA ELASTICA D10 ZINCATA	4.000	PZ	RC1130A0	FASCETTA 130X2,6	1.000	PZ	RC1131A0	FASCETTA 200X2,6 BIANC	2.000	PZ	RC1242A0	TERMINALE CHIUSO D10	2.000	PZ	TB2821A0	TB2820A-L=40 MM EPDM NER	3.000	PZ	VL1019A0	POMPA DETERGENTE VIBRAZIONE	1.000	PZ	VL1128A1	VALVOLA VNR BARBED D6	1.000	PZ	VL1174C0	UGELLO CALIBRATO D1.2 MM	1.000	PZ	VL1185A0	DISTRIBUTOR E LAVAGGIO PLUS 2 VIE UGELLO	1.000	PZ	VL1190A0	DISTRIBUTOR E INGRESSI LAVAGGIO PLUS	1.000	PZ	VM2172A0	CLIP BLOCCAGGIO POMPA CON CIRCUITO	1.000	PZ
					Code	Description	Qty	UOM																																																					
					EL1346A0	CLIP BLOCCA PINZETTA RACCORDI D10 TIERRE	2.000	PZ																																																					
					GN1526A0	O-RING D.INT6,9 SP1.8	1.000	PZ																																																					
					RC1019A0	FASCETTA ELASTICA D10 ZINCATA	4.000	PZ																																																					
					RC1130A0	FASCETTA 130X2,6	1.000	PZ																																																					
					RC1131A0	FASCETTA 200X2,6 BIANC	2.000	PZ																																																					
					RC1242A0	TERMINALE CHIUSO D10	2.000	PZ																																																					
					TB2821A0	TB2820A-L=40 MM EPDM NER	3.000	PZ																																																					
					VL1019A0	POMPA DETERGENTE VIBRAZIONE	1.000	PZ																																																					
					VL1128A1	VALVOLA VNR BARBED D6	1.000	PZ																																																					
					VL1174C0	UGELLO CALIBRATO D1.2 MM	1.000	PZ																																																					
					VL1185A0	DISTRIBUTOR E LAVAGGIO PLUS 2 VIE UGELLO	1.000	PZ																																																					
					VL1190A0	DISTRIBUTOR E INGRESSI LAVAGGIO PLUS	1.000	PZ																																																					
VM2172A0	CLIP BLOCCAGGIO POMPA CON CIRCUITO	1.000	PZ																																																										
VL1214A	VALVOLA VNR BB6-BAIONETTA		KVL1214A	6mm BARBED-BAYONET NRV VALVE KIT	<table border="1"> <thead> <tr> <th>Code</th> <th>Description</th> <th>Qty</th> <th>UOM</th> </tr> </thead> <tbody> <tr> <td>RC1019A0</td> <td>FASCETTA ELASTICA D10 ZINCATA</td> <td>2.000</td> <td>PZ</td> </tr> <tr> <td>TB2820A0</td> <td>TUBO EPDM 6X10</td> <td>0.100</td> <td>M</td> </tr> <tr> <td>VL1214A0</td> <td>VALVOLA VNR BB6-BAIONET TA</td> <td>1.000</td> <td>PZ</td> </tr> </tbody> </table>	Code	Description	Qty	UOM	RC1019A0	FASCETTA ELASTICA D10 ZINCATA	2.000	PZ	TB2820A0	TUBO EPDM 6X10	0.100	M	VL1214A0	VALVOLA VNR BB6-BAIONET TA	1.000	PZ																																								
					Code	Description	Qty	UOM																																																					
					RC1019A0	FASCETTA ELASTICA D10 ZINCATA	2.000	PZ																																																					
TB2820A0	TUBO EPDM 6X10	0.100	M																																																										
VL1214A0	VALVOLA VNR BB6-BAIONET TA	1.000	PZ																																																										

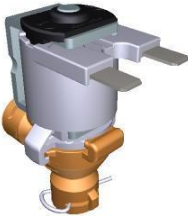
COMPONENT			SPARE PART																																										
Code	Description	Image	Code	Description	Kit components																																								
VL1398B	PRESSURE CONTROLLER N.O. 1/4 M CIL		VL1398B0	PRESSURE CONTROLLER N.O. 1/4 M CIL																																									
VM2172A	CLIP BLOCCAGGIO POMPA CON CIRCUITO		VM2172A0	CLIP BLOCCAGGIO POMPA CON CIRCUITO																																									
EL1440A	ELETTROVALVOLA H2O AUTOPULENTE BAF EU		KVL2618A	2 ROTOR ARMS ONE CLEANING SYSTEM KIT	<table border="1"> <thead> <tr> <th>Code</th> <th>Description</th> <th>Qty</th> <th>UOM</th> </tr> </thead> <tbody> <tr> <td>0H2202A1</td> <td>STAFFA LAVAGGIO ONE CON ELV STEAM</td> <td>2.000</td> <td>PZ</td> </tr> <tr> <td>CE1030A0</td> <td>FASTON FEMMINA 6.3X0.8 0.5-1mmq</td> <td>4.000</td> <td>PZ</td> </tr> <tr> <td>CE1395A0</td> <td>FASTON MASCHIO 6,3 X 0,8 RAME STAGNATO</td> <td>2.000</td> <td>PZ</td> </tr> <tr> <td>CE1545A0</td> <td>CAVO UNIP AWG18 ST.3135 BLU</td> <td>2.000</td> <td>M</td> </tr> <tr> <td>CE1570A0</td> <td>CAVO UNIP AWG18 ST.3135 BIANC</td> <td>2.000</td> <td>M</td> </tr> <tr> <td>CE1660A0</td> <td>COPRI FASTON FEMMINA 6.3X0.8</td> <td>4.000</td> <td>PZ</td> </tr> <tr> <td>CE1661A0</td> <td>COPRI FASTON MASCHIO 6.3X0.8</td> <td>2.000</td> <td>PZ</td> </tr> <tr> <td>EL1020A1</td> <td>RACCORDO INTERMEDIO "T" TUBO D8 J</td> <td>1.000</td> <td>PZ</td> </tr> <tr> <td>EL1346A0</td> <td>CLIP BLOCCA PINZETTA RACCORDI D10 TIERRE</td> <td>4.000</td> <td>PZ</td> </tr> </tbody> </table>	Code	Description	Qty	UOM	0H2202A1	STAFFA LAVAGGIO ONE CON ELV STEAM	2.000	PZ	CE1030A0	FASTON FEMMINA 6.3X0.8 0.5-1mmq	4.000	PZ	CE1395A0	FASTON MASCHIO 6,3 X 0,8 RAME STAGNATO	2.000	PZ	CE1545A0	CAVO UNIP AWG18 ST.3135 BLU	2.000	M	CE1570A0	CAVO UNIP AWG18 ST.3135 BIANC	2.000	M	CE1660A0	COPRI FASTON FEMMINA 6.3X0.8	4.000	PZ	CE1661A0	COPRI FASTON MASCHIO 6.3X0.8	2.000	PZ	EL1020A1	RACCORDO INTERMEDIO "T" TUBO D8 J	1.000	PZ	EL1346A0	CLIP BLOCCA PINZETTA RACCORDI D10 TIERRE	4.000	PZ
Code	Description	Qty	UOM																																										
0H2202A1	STAFFA LAVAGGIO ONE CON ELV STEAM	2.000	PZ																																										
CE1030A0	FASTON FEMMINA 6.3X0.8 0.5-1mmq	4.000	PZ																																										
CE1395A0	FASTON MASCHIO 6,3 X 0,8 RAME STAGNATO	2.000	PZ																																										
CE1545A0	CAVO UNIP AWG18 ST.3135 BLU	2.000	M																																										
CE1570A0	CAVO UNIP AWG18 ST.3135 BIANC	2.000	M																																										
CE1660A0	COPRI FASTON FEMMINA 6.3X0.8	4.000	PZ																																										
CE1661A0	COPRI FASTON MASCHIO 6.3X0.8	2.000	PZ																																										
EL1020A1	RACCORDO INTERMEDIO "T" TUBO D8 J	1.000	PZ																																										
EL1346A0	CLIP BLOCCA PINZETTA RACCORDI D10 TIERRE	4.000	PZ																																										

COMPONENT			SPARE PART																																																																																		
Code	Description	Image	Code	Description	Kit components																																																																																
EL1440A	ELETTROVALVOLA H2O AUTOPULENTE BAF EU		KVL2618A	2 ROTOR ARMS ONE CLEANING SYSTEM KIT	<table border="1"> <thead> <tr> <th>Code</th> <th>Description</th> <th>Qty</th> <th>UOM</th> </tr> </thead> <tbody> <tr> <td>EL1440A0</td> <td>ELETTROVALV OLA H2O AUTOPULENTE E BAF EU</td> <td>2.000</td> <td>PZ</td> </tr> <tr> <td>GN1526A0</td> <td>O-RING D.INT6,9 SP1.8</td> <td>6.000</td> <td>PZ</td> </tr> <tr> <td>RC1018A0</td> <td>FASCETTA ELASTICA D12 ZINCATA</td> <td>2.000</td> <td>PZ</td> </tr> <tr> <td>RC1019A0</td> <td>FASCETTA ELASTICA D10 ZINCATA</td> <td>3.000</td> <td>PZ</td> </tr> <tr> <td>RC1130A0</td> <td>FASCETTA 130X2,6</td> <td>4.000</td> <td>PZ</td> </tr> <tr> <td>RC1242A0</td> <td>TERMINALE CHIUSO D10</td> <td>4.000</td> <td>PZ</td> </tr> <tr> <td>RC1414A1</td> <td>FASCETTA STRINGITUBO A SCATTO D11,5-12,5</td> <td>5.000</td> <td>PZ</td> </tr> <tr> <td>TB2821A0</td> <td>TB2820A-L=40 MM EPDM NER</td> <td>12.000</td> <td>PZ</td> </tr> <tr> <td>TB3004A0</td> <td>TB2820A-L=57 0MM EPDM NERO</td> <td>2.000</td> <td>PZ</td> </tr> <tr> <td>TB3009B0</td> <td>TB3132A-L=67 0MM EPDM BIANCO BLU</td> <td>2.000</td> <td>PZ</td> </tr> <tr> <td>TB3225B0</td> <td>TB2820A-TUB O EPDM NERO 670MM</td> <td>2.000</td> <td>PZ</td> </tr> <tr> <td>VH1220A1</td> <td>VITE AUTOFIL. 4.2X11 TCS+ MARUTEX</td> <td>2.000</td> <td>PZ</td> </tr> <tr> <td>VL1019A0</td> <td>POMPA DETERGENTE VIBRAZIONE</td> <td>2.000</td> <td>PZ</td> </tr> <tr> <td>VL1047A1</td> <td>PORTAGOMM A D6 CODOLO D8</td> <td>2.000</td> <td>PZ</td> </tr> <tr> <td>VL1054B0</td> <td>DISTRIBUTOR E INGRESSI LAVAGGIO ON</td> <td>2.000</td> <td>PZ</td> </tr> <tr> <td>VL1102A1</td> <td>FILTRO IN LINEA DET. + VNR BARBED 6 MM</td> <td>2.000</td> <td>PZ</td> </tr> <tr> <td>VL1127A1</td> <td>RACCORDO A T BARBED 6</td> <td>1.000</td> <td>PZ</td> </tr> <tr> <td>VL1128A1</td> <td>VALVOLA VNR BARBED D6</td> <td>4.000</td> <td>PZ</td> </tr> <tr> <td>VL1166A0</td> <td>RACCORDO A L BAM-BB6</td> <td>2.000</td> <td>PZ</td> </tr> </tbody> </table>	Code	Description	Qty	UOM	EL1440A0	ELETTROVALV OLA H2O AUTOPULENTE E BAF EU	2.000	PZ	GN1526A0	O-RING D.INT6,9 SP1.8	6.000	PZ	RC1018A0	FASCETTA ELASTICA D12 ZINCATA	2.000	PZ	RC1019A0	FASCETTA ELASTICA D10 ZINCATA	3.000	PZ	RC1130A0	FASCETTA 130X2,6	4.000	PZ	RC1242A0	TERMINALE CHIUSO D10	4.000	PZ	RC1414A1	FASCETTA STRINGITUBO A SCATTO D11,5-12,5	5.000	PZ	TB2821A0	TB2820A-L=40 MM EPDM NER	12.000	PZ	TB3004A0	TB2820A-L=57 0MM EPDM NERO	2.000	PZ	TB3009B0	TB3132A-L=67 0MM EPDM BIANCO BLU	2.000	PZ	TB3225B0	TB2820A-TUB O EPDM NERO 670MM	2.000	PZ	VH1220A1	VITE AUTOFIL. 4.2X11 TCS+ MARUTEX	2.000	PZ	VL1019A0	POMPA DETERGENTE VIBRAZIONE	2.000	PZ	VL1047A1	PORTAGOMM A D6 CODOLO D8	2.000	PZ	VL1054B0	DISTRIBUTOR E INGRESSI LAVAGGIO ON	2.000	PZ	VL1102A1	FILTRO IN LINEA DET. + VNR BARBED 6 MM	2.000	PZ	VL1127A1	RACCORDO A T BARBED 6	1.000	PZ	VL1128A1	VALVOLA VNR BARBED D6	4.000	PZ	VL1166A0	RACCORDO A L BAM-BB6	2.000	PZ
Code	Description	Qty	UOM																																																																																		
EL1440A0	ELETTROVALV OLA H2O AUTOPULENTE E BAF EU	2.000	PZ																																																																																		
GN1526A0	O-RING D.INT6,9 SP1.8	6.000	PZ																																																																																		
RC1018A0	FASCETTA ELASTICA D12 ZINCATA	2.000	PZ																																																																																		
RC1019A0	FASCETTA ELASTICA D10 ZINCATA	3.000	PZ																																																																																		
RC1130A0	FASCETTA 130X2,6	4.000	PZ																																																																																		
RC1242A0	TERMINALE CHIUSO D10	4.000	PZ																																																																																		
RC1414A1	FASCETTA STRINGITUBO A SCATTO D11,5-12,5	5.000	PZ																																																																																		
TB2821A0	TB2820A-L=40 MM EPDM NER	12.000	PZ																																																																																		
TB3004A0	TB2820A-L=57 0MM EPDM NERO	2.000	PZ																																																																																		
TB3009B0	TB3132A-L=67 0MM EPDM BIANCO BLU	2.000	PZ																																																																																		
TB3225B0	TB2820A-TUB O EPDM NERO 670MM	2.000	PZ																																																																																		
VH1220A1	VITE AUTOFIL. 4.2X11 TCS+ MARUTEX	2.000	PZ																																																																																		
VL1019A0	POMPA DETERGENTE VIBRAZIONE	2.000	PZ																																																																																		
VL1047A1	PORTAGOMM A D6 CODOLO D8	2.000	PZ																																																																																		
VL1054B0	DISTRIBUTOR E INGRESSI LAVAGGIO ON	2.000	PZ																																																																																		
VL1102A1	FILTRO IN LINEA DET. + VNR BARBED 6 MM	2.000	PZ																																																																																		
VL1127A1	RACCORDO A T BARBED 6	1.000	PZ																																																																																		
VL1128A1	VALVOLA VNR BARBED D6	4.000	PZ																																																																																		
VL1166A0	RACCORDO A L BAM-BB6	2.000	PZ																																																																																		

COMPONENT			SPARE PART																																																											
Code	Description	Image	Code	Description	Kit components																																																									
EL1440A	ELETTRORVALVOLA H2O AUTOPULENTE BAF EU		KVL2618A	2 ROTOR ARMS ONE CLEANING SYSTEM KIT	<table border="1"> <thead> <tr> <th>Code</th> <th>Description</th> <th>Qty</th> <th>UOM</th> </tr> </thead> <tbody> <tr> <td>VL1174C0</td> <td>UGELLO CALIBRATO D1.2 MM</td> <td>2.000</td> <td>PZ</td> </tr> <tr> <td>VL1191A0</td> <td>DISTRIBUTOR E USCITA LAVAGGIO ON</td> <td>2.000</td> <td>PZ</td> </tr> <tr> <td>VL1214A0</td> <td>VALVOLA VNR BB6-BAIONET TA</td> <td>2.000</td> <td>PZ</td> </tr> <tr> <td>VM2172A0</td> <td>CLIP BLOCCAGGIO POMPA CON CIRCUITO</td> <td>4.000</td> <td>PZ</td> </tr> </tbody> </table>	Code	Description	Qty	UOM	VL1174C0	UGELLO CALIBRATO D1.2 MM	2.000	PZ	VL1191A0	DISTRIBUTOR E USCITA LAVAGGIO ON	2.000	PZ	VL1214A0	VALVOLA VNR BB6-BAIONET TA	2.000	PZ	VM2172A0	CLIP BLOCCAGGIO POMPA CON CIRCUITO	4.000	PZ																																					
			Code	Description	Qty	UOM																																																								
VL1174C0	UGELLO CALIBRATO D1.2 MM	2.000	PZ																																																											
VL1191A0	DISTRIBUTOR E USCITA LAVAGGIO ON	2.000	PZ																																																											
VL1214A0	VALVOLA VNR BB6-BAIONET TA	2.000	PZ																																																											
VM2172A0	CLIP BLOCCAGGIO POMPA CON CIRCUITO	4.000	PZ																																																											
KVL1222A	EUR 0311 ONE PLUS CLEANING SYSTEM KIT	<table border="1"> <thead> <tr> <th>Code</th> <th>Description</th> <th>Qty</th> <th>UOM</th> </tr> </thead> <tbody> <tr> <td>0H2486A0</td> <td>LAMIERA IMPIANTO LAVAGGIO 031</td> <td>1.000</td> <td>PZ</td> </tr> <tr> <td>EL1346A0</td> <td>CLIP BLOCCA PINZETTA RACCORDI D10 TIERRE</td> <td>2.000</td> <td>PZ</td> </tr> <tr> <td>EL1440A0</td> <td>ELETTRORVALV OLA H2O AUTOPULENTE E BAF EU</td> <td>1.000</td> <td>PZ</td> </tr> <tr> <td>GN1526A0</td> <td>O-RING D.INT6,9 SP1.8</td> <td>3.000</td> <td>PZ</td> </tr> <tr> <td>RC1019A0</td> <td>FASCETTA ELASTICA D10 ZINCATO</td> <td>12.000</td> <td>PZ</td> </tr> <tr> <td>RC1242A0</td> <td>TERMINALE CHIUSO D10</td> <td>2.000</td> <td>PZ</td> </tr> <tr> <td>RC1414A1</td> <td>FASCETTA STRINGITUBO A SCATTO D11.5-12.5</td> <td>1.000</td> <td>PZ</td> </tr> <tr> <td>TB2821A0</td> <td>TB2820A-L=40 MM EPDM NER</td> <td>4.000</td> <td>PZ</td> </tr> <tr> <td>TB3004A0</td> <td>TB2820A-L=57 0MM EPDM NERO</td> <td>1.000</td> <td>PZ</td> </tr> <tr> <td>TB3009B0</td> <td>TB3132A-L=67 0MM EPDM BIANCO BLU</td> <td>1.000</td> <td>PZ</td> </tr> <tr> <td>TB3225B0</td> <td>TB2820A-TUB O EPDM NERO 670MM</td> <td>1.000</td> <td>PZ</td> </tr> <tr> <td>TB3614A0</td> <td>TB2820A-L=96 MM NERO EPD</td> <td>1.000</td> <td>PZ</td> </tr> <tr> <td>VI1220A1</td> <td>VITE AUTOFIL 4.2X11 TCS+ MARUTEX</td> <td>4.000</td> <td>PZ</td> </tr> <tr> <td>VI2070A0</td> <td>VITE AUTOFIL 40X8 TCB+ SHEETTRACS</td> <td>2.000</td> <td>PZ</td> </tr> </tbody> </table>	Code	Description	Qty	UOM	0H2486A0	LAMIERA IMPIANTO LAVAGGIO 031	1.000	PZ	EL1346A0	CLIP BLOCCA PINZETTA RACCORDI D10 TIERRE	2.000	PZ	EL1440A0	ELETTRORVALV OLA H2O AUTOPULENTE E BAF EU	1.000	PZ	GN1526A0	O-RING D.INT6,9 SP1.8	3.000	PZ	RC1019A0	FASCETTA ELASTICA D10 ZINCATO	12.000	PZ	RC1242A0	TERMINALE CHIUSO D10	2.000	PZ	RC1414A1	FASCETTA STRINGITUBO A SCATTO D11.5-12.5	1.000	PZ	TB2821A0	TB2820A-L=40 MM EPDM NER	4.000	PZ	TB3004A0	TB2820A-L=57 0MM EPDM NERO	1.000	PZ	TB3009B0	TB3132A-L=67 0MM EPDM BIANCO BLU	1.000	PZ	TB3225B0	TB2820A-TUB O EPDM NERO 670MM	1.000	PZ	TB3614A0	TB2820A-L=96 MM NERO EPD	1.000	PZ	VI1220A1	VITE AUTOFIL 4.2X11 TCS+ MARUTEX	4.000	PZ	VI2070A0	VITE AUTOFIL 40X8 TCB+ SHEETTRACS	2.000	PZ
Code	Description	Qty	UOM																																																											
0H2486A0	LAMIERA IMPIANTO LAVAGGIO 031	1.000	PZ																																																											
EL1346A0	CLIP BLOCCA PINZETTA RACCORDI D10 TIERRE	2.000	PZ																																																											
EL1440A0	ELETTRORVALV OLA H2O AUTOPULENTE E BAF EU	1.000	PZ																																																											
GN1526A0	O-RING D.INT6,9 SP1.8	3.000	PZ																																																											
RC1019A0	FASCETTA ELASTICA D10 ZINCATO	12.000	PZ																																																											
RC1242A0	TERMINALE CHIUSO D10	2.000	PZ																																																											
RC1414A1	FASCETTA STRINGITUBO A SCATTO D11.5-12.5	1.000	PZ																																																											
TB2821A0	TB2820A-L=40 MM EPDM NER	4.000	PZ																																																											
TB3004A0	TB2820A-L=57 0MM EPDM NERO	1.000	PZ																																																											
TB3009B0	TB3132A-L=67 0MM EPDM BIANCO BLU	1.000	PZ																																																											
TB3225B0	TB2820A-TUB O EPDM NERO 670MM	1.000	PZ																																																											
TB3614A0	TB2820A-L=96 MM NERO EPD	1.000	PZ																																																											
VI1220A1	VITE AUTOFIL 4.2X11 TCS+ MARUTEX	4.000	PZ																																																											
VI2070A0	VITE AUTOFIL 40X8 TCB+ SHEETTRACS	2.000	PZ																																																											

COMPONENT			SPARE PART																																														
Code	Description	Image	Code	Description	Kit components																																												
EL1440A	ELETTRORVALVOLA H2O AUTOPULENTE BAF EU		KVL1222A	EUR 0311 ONE PLUS CLEANING SYSTEM KIT	<table border="1"> <thead> <tr> <th>Code</th> <th>Description</th> <th>Qty</th> <th>UOM</th> </tr> </thead> <tbody> <tr> <td>VL1019A0</td> <td>POMPA DETERGENTE VIBRAZIONE</td> <td>1.000</td> <td>PZ</td> </tr> <tr> <td>VL1047A1</td> <td>PORTAGOMM A D6 CODOLO D8</td> <td>1.000</td> <td>PZ</td> </tr> <tr> <td>VL1054B0</td> <td>DISTRIBUTOR E INGRESSI LAVAGGIO ON</td> <td>1.000</td> <td>PZ</td> </tr> <tr> <td>VL1102A1</td> <td>FILTRO IN LINEA DET. + VNR BARBED 6 MM</td> <td>1.000</td> <td>PZ</td> </tr> <tr> <td>VL1128A1</td> <td>VALVOLA VNR BARBED D6</td> <td>1.000</td> <td>PZ</td> </tr> <tr> <td>VL1166A0</td> <td>RACCORDO A L BAM-BB6</td> <td>1.000</td> <td>PZ</td> </tr> <tr> <td>VL1174C0</td> <td>UGELLO CALIBRATO D1.2 MM</td> <td>1.000</td> <td>PZ</td> </tr> <tr> <td>VL1191A0</td> <td>DISTRIBUTOR E USCITA LAVAGGIO ON</td> <td>1.000</td> <td>PZ</td> </tr> <tr> <td>VL1214A0</td> <td>VALVOLA VNR BB6-BAIONET TA</td> <td>1.000</td> <td>PZ</td> </tr> <tr> <td>VM2172A0</td> <td>CLIP BLOCCAGGIO POMPA CON CIRCUITO</td> <td>2.000</td> <td>PZ</td> </tr> </tbody> </table>	Code	Description	Qty	UOM	VL1019A0	POMPA DETERGENTE VIBRAZIONE	1.000	PZ	VL1047A1	PORTAGOMM A D6 CODOLO D8	1.000	PZ	VL1054B0	DISTRIBUTOR E INGRESSI LAVAGGIO ON	1.000	PZ	VL1102A1	FILTRO IN LINEA DET. + VNR BARBED 6 MM	1.000	PZ	VL1128A1	VALVOLA VNR BARBED D6	1.000	PZ	VL1166A0	RACCORDO A L BAM-BB6	1.000	PZ	VL1174C0	UGELLO CALIBRATO D1.2 MM	1.000	PZ	VL1191A0	DISTRIBUTOR E USCITA LAVAGGIO ON	1.000	PZ	VL1214A0	VALVOLA VNR BB6-BAIONET TA	1.000	PZ	VM2172A0	CLIP BLOCCAGGIO POMPA CON CIRCUITO	2.000	PZ
			Code	Description	Qty	UOM																																											
VL1019A0	POMPA DETERGENTE VIBRAZIONE	1.000	PZ																																														
VL1047A1	PORTAGOMM A D6 CODOLO D8	1.000	PZ																																														
VL1054B0	DISTRIBUTOR E INGRESSI LAVAGGIO ON	1.000	PZ																																														
VL1102A1	FILTRO IN LINEA DET. + VNR BARBED 6 MM	1.000	PZ																																														
VL1128A1	VALVOLA VNR BARBED D6	1.000	PZ																																														
VL1166A0	RACCORDO A L BAM-BB6	1.000	PZ																																														
VL1174C0	UGELLO CALIBRATO D1.2 MM	1.000	PZ																																														
VL1191A0	DISTRIBUTOR E USCITA LAVAGGIO ON	1.000	PZ																																														
VL1214A0	VALVOLA VNR BB6-BAIONET TA	1.000	PZ																																														
VM2172A0	CLIP BLOCCAGGIO POMPA CON CIRCUITO	2.000	PZ																																														
KVL1212A	EUR COMPACT PLUS CLEANING SYSTEM KIT	<table border="1"> <thead> <tr> <th>Code</th> <th>Description</th> <th>Qty</th> <th>UOM</th> </tr> </thead> <tbody> <tr> <td>0H2428A2</td> <td>LAMIERA IMPIANTO LAVAGGIO XECC PLUS</td> <td>1.000</td> <td>PZ</td> </tr> <tr> <td>EL1346A0</td> <td>CLIP BLOCCA PINZETTA RACCORDI D10 TIERRE</td> <td>2.000</td> <td>PZ</td> </tr> <tr> <td>EL1440A0</td> <td>ELETTRORVALV OLA H2O AUTOPULENT E BAF EU</td> <td>3.000</td> <td>PZ</td> </tr> <tr> <td>GN1311A0</td> <td>PASSACAVO GOMMA DE=25 DI=12 SP=6.5</td> <td>1.000</td> <td>PZ</td> </tr> <tr> <td>GN1526A0</td> <td>O-RING D.INT6.9 SP1.8</td> <td>7.000</td> <td>PZ</td> </tr> <tr> <td>RC1018A0</td> <td>FASCETTA ELASTICA D12 ZINCATA</td> <td>5.000</td> <td>PZ</td> </tr> </tbody> </table>	Code	Description	Qty	UOM	0H2428A2	LAMIERA IMPIANTO LAVAGGIO XECC PLUS	1.000	PZ	EL1346A0	CLIP BLOCCA PINZETTA RACCORDI D10 TIERRE	2.000	PZ	EL1440A0	ELETTRORVALV OLA H2O AUTOPULENT E BAF EU	3.000	PZ	GN1311A0	PASSACAVO GOMMA DE=25 DI=12 SP=6.5	1.000	PZ	GN1526A0	O-RING D.INT6.9 SP1.8	7.000	PZ	RC1018A0	FASCETTA ELASTICA D12 ZINCATA	5.000	PZ																			
Code	Description	Qty	UOM																																														
0H2428A2	LAMIERA IMPIANTO LAVAGGIO XECC PLUS	1.000	PZ																																														
EL1346A0	CLIP BLOCCA PINZETTA RACCORDI D10 TIERRE	2.000	PZ																																														
EL1440A0	ELETTRORVALV OLA H2O AUTOPULENT E BAF EU	3.000	PZ																																														
GN1311A0	PASSACAVO GOMMA DE=25 DI=12 SP=6.5	1.000	PZ																																														
GN1526A0	O-RING D.INT6.9 SP1.8	7.000	PZ																																														
RC1018A0	FASCETTA ELASTICA D12 ZINCATA	5.000	PZ																																														

COMPONENT			SPARE PART																																																																																		
Code	Description	Image	Code	Description	Kit components																																																																																
EL1440A	ELETTRIVALVOLA H2O AUTOPULENTE BAF EU		KVL1212A	EUR COMPACT PLUS CLEANING SYSTEM KIT	<table border="1"> <thead> <tr> <th>Code</th> <th>Description</th> <th>Qty</th> <th>UOM</th> </tr> </thead> <tbody> <tr> <td>RC1019A0</td> <td>FASCETTA ELASTICA D10 ZINCATA</td> <td>14.000</td> <td>PZ</td> </tr> <tr> <td>RC1130A0</td> <td>FASCETTA 130X2,6</td> <td>1.000</td> <td>PZ</td> </tr> <tr> <td>RC1131A0</td> <td>FASCETTA 200X2,6 BIANCO</td> <td>1.000</td> <td>PZ</td> </tr> <tr> <td>RC1242A0</td> <td>TERMINALE CHIUSO D10</td> <td>2.000</td> <td>PZ</td> </tr> <tr> <td>RC1356A0</td> <td>RACCORDO DRITTO FIL. FEMM 8X1/4 BSP</td> <td>1.000</td> <td>PZ</td> </tr> <tr> <td>RC1414A1</td> <td>FASCETTA STRINGITUBO A SCATTO D11.5-12.5</td> <td>4.000</td> <td>PZ</td> </tr> <tr> <td>TB2821A0</td> <td>TB2820A-L=40 MM EPDM NER</td> <td>6.000</td> <td>PZ</td> </tr> <tr> <td>TB3004A0</td> <td>TB2820A-L=57 0MM EPDM NERO</td> <td>2.000</td> <td>PZ</td> </tr> <tr> <td>TB3005B0</td> <td>TB3132A-L=55 0MM EPDM BIANCO BLU</td> <td>1.000</td> <td>PZ</td> </tr> <tr> <td>TB3252A0</td> <td>TB3132A-L=23 0MM EPDM BIANCO BLU</td> <td>1.000</td> <td>PZ</td> </tr> <tr> <td>TB3469A0</td> <td>TB3132A-L=38 0MM EPDM BIANCO-BLU</td> <td>1.000</td> <td>PZ</td> </tr> <tr> <td>VH1220A1</td> <td>VITE AUTOFIL. 4.2X11 TCS+ MARUTEX</td> <td>3.000</td> <td>PZ</td> </tr> <tr> <td>VL1019A0</td> <td>POMPA DETERGENTE VIBRAZIONE</td> <td>1.000</td> <td>PZ</td> </tr> <tr> <td>VL1047A1</td> <td>PORTAGOMM A D6 CODOLO D8</td> <td>1.000</td> <td>PZ</td> </tr> <tr> <td>VL1054B0</td> <td>DISTRIBUTOR E INGRESSI LAVAGGIO ON</td> <td>1.000</td> <td>PZ</td> </tr> <tr> <td>VL1102A1</td> <td>FILTRO IN LINEA DET. + VNR BARBED 6 MM</td> <td>1.000</td> <td>PZ</td> </tr> <tr> <td>VL1127A1</td> <td>RACCORDO A T BARBED 6</td> <td>1.000</td> <td>PZ</td> </tr> <tr> <td>VL1128A1</td> <td>VALVOLA VNR BARBED D6</td> <td>2.000</td> <td>PZ</td> </tr> <tr> <td>VL1165A0</td> <td>RACCORDO DRITTO BAM-BB6</td> <td>1.000</td> <td>PZ</td> </tr> </tbody> </table>	Code	Description	Qty	UOM	RC1019A0	FASCETTA ELASTICA D10 ZINCATA	14.000	PZ	RC1130A0	FASCETTA 130X2,6	1.000	PZ	RC1131A0	FASCETTA 200X2,6 BIANCO	1.000	PZ	RC1242A0	TERMINALE CHIUSO D10	2.000	PZ	RC1356A0	RACCORDO DRITTO FIL. FEMM 8X1/4 BSP	1.000	PZ	RC1414A1	FASCETTA STRINGITUBO A SCATTO D11.5-12.5	4.000	PZ	TB2821A0	TB2820A-L=40 MM EPDM NER	6.000	PZ	TB3004A0	TB2820A-L=57 0MM EPDM NERO	2.000	PZ	TB3005B0	TB3132A-L=55 0MM EPDM BIANCO BLU	1.000	PZ	TB3252A0	TB3132A-L=23 0MM EPDM BIANCO BLU	1.000	PZ	TB3469A0	TB3132A-L=38 0MM EPDM BIANCO-BLU	1.000	PZ	VH1220A1	VITE AUTOFIL. 4.2X11 TCS+ MARUTEX	3.000	PZ	VL1019A0	POMPA DETERGENTE VIBRAZIONE	1.000	PZ	VL1047A1	PORTAGOMM A D6 CODOLO D8	1.000	PZ	VL1054B0	DISTRIBUTOR E INGRESSI LAVAGGIO ON	1.000	PZ	VL1102A1	FILTRO IN LINEA DET. + VNR BARBED 6 MM	1.000	PZ	VL1127A1	RACCORDO A T BARBED 6	1.000	PZ	VL1128A1	VALVOLA VNR BARBED D6	2.000	PZ	VL1165A0	RACCORDO DRITTO BAM-BB6	1.000	PZ
Code	Description	Qty	UOM																																																																																		
RC1019A0	FASCETTA ELASTICA D10 ZINCATA	14.000	PZ																																																																																		
RC1130A0	FASCETTA 130X2,6	1.000	PZ																																																																																		
RC1131A0	FASCETTA 200X2,6 BIANCO	1.000	PZ																																																																																		
RC1242A0	TERMINALE CHIUSO D10	2.000	PZ																																																																																		
RC1356A0	RACCORDO DRITTO FIL. FEMM 8X1/4 BSP	1.000	PZ																																																																																		
RC1414A1	FASCETTA STRINGITUBO A SCATTO D11.5-12.5	4.000	PZ																																																																																		
TB2821A0	TB2820A-L=40 MM EPDM NER	6.000	PZ																																																																																		
TB3004A0	TB2820A-L=57 0MM EPDM NERO	2.000	PZ																																																																																		
TB3005B0	TB3132A-L=55 0MM EPDM BIANCO BLU	1.000	PZ																																																																																		
TB3252A0	TB3132A-L=23 0MM EPDM BIANCO BLU	1.000	PZ																																																																																		
TB3469A0	TB3132A-L=38 0MM EPDM BIANCO-BLU	1.000	PZ																																																																																		
VH1220A1	VITE AUTOFIL. 4.2X11 TCS+ MARUTEX	3.000	PZ																																																																																		
VL1019A0	POMPA DETERGENTE VIBRAZIONE	1.000	PZ																																																																																		
VL1047A1	PORTAGOMM A D6 CODOLO D8	1.000	PZ																																																																																		
VL1054B0	DISTRIBUTOR E INGRESSI LAVAGGIO ON	1.000	PZ																																																																																		
VL1102A1	FILTRO IN LINEA DET. + VNR BARBED 6 MM	1.000	PZ																																																																																		
VL1127A1	RACCORDO A T BARBED 6	1.000	PZ																																																																																		
VL1128A1	VALVOLA VNR BARBED D6	2.000	PZ																																																																																		
VL1165A0	RACCORDO DRITTO BAM-BB6	1.000	PZ																																																																																		

COMPONENT			SPARE PART																																																							
Code	Description	Image	Code	Description	Kit components																																																					
EL1440A	ELETTRORVALVOLA H2O AUTOPULENTE BAF EU		KVL1212A	EUR COMPACT PLUS CLEANING SYSTEM KIT	<table border="1"> <thead> <tr> <th>Code</th> <th>Description</th> <th>Qty</th> <th>UOM</th> </tr> </thead> <tbody> <tr> <td>VL1166A0</td> <td>RACCORDO A L BAM-BB6</td> <td>3.000</td> <td>PZ</td> </tr> <tr> <td>VL1174C0</td> <td>UGELLO CALIBRATO D1.2 MM</td> <td>1.000</td> <td>PZ</td> </tr> <tr> <td>VL1185A0</td> <td>DISTRIBUTOR E LAVAGGIO PLUS 2 VIE UGELLO</td> <td>1.000</td> <td>PZ</td> </tr> <tr> <td>VL1398A0</td> <td>PRESSOSTAT O N.O. 1/4 M CI</td> <td>1.000</td> <td>PZ</td> </tr> <tr> <td>VM2172A0</td> <td>CLIP BLOCCAGGIO POMPA CON CIRCUITO</td> <td>3.000</td> <td>PZ</td> </tr> </tbody> </table>	Code	Description	Qty	UOM	VL1166A0	RACCORDO A L BAM-BB6	3.000	PZ	VL1174C0	UGELLO CALIBRATO D1.2 MM	1.000	PZ	VL1185A0	DISTRIBUTOR E LAVAGGIO PLUS 2 VIE UGELLO	1.000	PZ	VL1398A0	PRESSOSTAT O N.O. 1/4 M CI	1.000	PZ	VM2172A0	CLIP BLOCCAGGIO POMPA CON CIRCUITO	3.000	PZ																													
			Code	Description	Qty	UOM																																																				
VL1166A0	RACCORDO A L BAM-BB6	3.000	PZ																																																							
VL1174C0	UGELLO CALIBRATO D1.2 MM	1.000	PZ																																																							
VL1185A0	DISTRIBUTOR E LAVAGGIO PLUS 2 VIE UGELLO	1.000	PZ																																																							
VL1398A0	PRESSOSTAT O N.O. 1/4 M CI	1.000	PZ																																																							
VM2172A0	CLIP BLOCCAGGIO POMPA CON CIRCUITO	3.000	PZ																																																							
KVL1211A	ONE COMPACT AND 0523-EP WASH. SYSTEM KIT	<table border="1"> <thead> <tr> <th>Code</th> <th>Description</th> <th>Qty</th> <th>UOM</th> </tr> </thead> <tbody> <tr> <td>0H2427A0</td> <td>LAMIERA IMPIANTO LAVAGGIO XECC</td> <td>1.000</td> <td>PZ</td> </tr> <tr> <td>EL1346A0</td> <td>CLIP BLOCCA PINZETTA RACCORDI D10 TIERRE</td> <td>2.000</td> <td>PZ</td> </tr> <tr> <td>EL1440A0</td> <td>ELETTRORVALV OLA H2O AUTOPULENT E BAF EU</td> <td>1.000</td> <td>PZ</td> </tr> <tr> <td>GN1526A0</td> <td>O-RING D.INT6,9 SP1,8</td> <td>3.000</td> <td>PZ</td> </tr> <tr> <td>RC1018A0</td> <td>FASCETTA ELASTICA D12 ZINCATA</td> <td>4.000</td> <td>PZ</td> </tr> <tr> <td>RC1019A0</td> <td>FASCETTA ELASTICA D10 ZINCATA</td> <td>14.000</td> <td>PZ</td> </tr> <tr> <td>RC1130A0</td> <td>FASCETTA 130X2,6</td> <td>1.000</td> <td>PZ</td> </tr> <tr> <td>RC1242A0</td> <td>TERMINALE CHIUSO D10</td> <td>2.000</td> <td>PZ</td> </tr> <tr> <td>RC1414A1</td> <td>FASCETTA STRINGITUBO A SCATTO D11.5-12.5</td> <td>4.000</td> <td>PZ</td> </tr> <tr> <td>TB2821A0</td> <td>TB2820A-L=40 MM EPDM NER</td> <td>6.000</td> <td>PZ</td> </tr> <tr> <td>TB3004A0</td> <td>TB2820A-L=57 0MM EPDM NERO</td> <td>1.000</td> <td>PZ</td> </tr> <tr> <td>TB3252A0</td> <td>TB3132A-L=23 0MM EPDM BIANCO BLU</td> <td>1.000</td> <td>PZ</td> </tr> <tr> <td>TB3469A0</td> <td>TB3132A-L=38 0MM EPDM BIANCO-BLU</td> <td>1.000</td> <td>PZ</td> </tr> </tbody> </table>	Code	Description	Qty	UOM	0H2427A0	LAMIERA IMPIANTO LAVAGGIO XECC	1.000	PZ	EL1346A0	CLIP BLOCCA PINZETTA RACCORDI D10 TIERRE	2.000	PZ	EL1440A0	ELETTRORVALV OLA H2O AUTOPULENT E BAF EU	1.000	PZ	GN1526A0	O-RING D.INT6,9 SP1,8	3.000	PZ	RC1018A0	FASCETTA ELASTICA D12 ZINCATA	4.000	PZ	RC1019A0	FASCETTA ELASTICA D10 ZINCATA	14.000	PZ	RC1130A0	FASCETTA 130X2,6	1.000	PZ	RC1242A0	TERMINALE CHIUSO D10	2.000	PZ	RC1414A1	FASCETTA STRINGITUBO A SCATTO D11.5-12.5	4.000	PZ	TB2821A0	TB2820A-L=40 MM EPDM NER	6.000	PZ	TB3004A0	TB2820A-L=57 0MM EPDM NERO	1.000	PZ	TB3252A0	TB3132A-L=23 0MM EPDM BIANCO BLU	1.000	PZ	TB3469A0	TB3132A-L=38 0MM EPDM BIANCO-BLU	1.000	PZ
Code	Description	Qty	UOM																																																							
0H2427A0	LAMIERA IMPIANTO LAVAGGIO XECC	1.000	PZ																																																							
EL1346A0	CLIP BLOCCA PINZETTA RACCORDI D10 TIERRE	2.000	PZ																																																							
EL1440A0	ELETTRORVALV OLA H2O AUTOPULENT E BAF EU	1.000	PZ																																																							
GN1526A0	O-RING D.INT6,9 SP1,8	3.000	PZ																																																							
RC1018A0	FASCETTA ELASTICA D12 ZINCATA	4.000	PZ																																																							
RC1019A0	FASCETTA ELASTICA D10 ZINCATA	14.000	PZ																																																							
RC1130A0	FASCETTA 130X2,6	1.000	PZ																																																							
RC1242A0	TERMINALE CHIUSO D10	2.000	PZ																																																							
RC1414A1	FASCETTA STRINGITUBO A SCATTO D11.5-12.5	4.000	PZ																																																							
TB2821A0	TB2820A-L=40 MM EPDM NER	6.000	PZ																																																							
TB3004A0	TB2820A-L=57 0MM EPDM NERO	1.000	PZ																																																							
TB3252A0	TB3132A-L=23 0MM EPDM BIANCO BLU	1.000	PZ																																																							
TB3469A0	TB3132A-L=38 0MM EPDM BIANCO-BLU	1.000	PZ																																																							

COMPONENT			SPARE PART																																																						
Code	Description	Image	Code	Description	Kit components																																																				
EL1440A	ELETTRORVALVOLA H2O AUTOPULENTE BAF EU		KVL1211A	ONE COMPACT AND 0523-EP WASH. SYSTEM KIT	<table border="1"> <thead> <tr> <th>Code</th> <th>Description</th> <th>Qty</th> <th>UOM</th> </tr> </thead> <tbody> <tr> <td>VI1220A1</td> <td>VITE AUTOFIL. 4.2X11 TCS+ MARUTEX</td> <td>4.000</td> <td>PZ</td> </tr> <tr> <td>VL1019A0</td> <td>POMPA DETERGENTE VIBRAZIONE</td> <td>1.000</td> <td>PZ</td> </tr> <tr> <td>VL1047A1</td> <td>PORTAGOMM A D6 CODOLO D8</td> <td>1.000</td> <td>PZ</td> </tr> <tr> <td>VL1054B0</td> <td>DISTRIBUTOR E INGRESSI LAVAGGIO ON</td> <td>1.000</td> <td>PZ</td> </tr> <tr> <td>VL1102A1</td> <td>FILTRO IN LINEA DET. + VNR BARBED 6 MM</td> <td>1.000</td> <td>PZ</td> </tr> <tr> <td>VL1127A1</td> <td>RACCORDO A T BARBED 6</td> <td>1.000</td> <td>PZ</td> </tr> <tr> <td>VL1128A1</td> <td>VALVOLA VNR BARBED D6</td> <td>2.000</td> <td>PZ</td> </tr> <tr> <td>VL1165A0</td> <td>RACCORDO DRITTO BAM-BB6</td> <td>1.000</td> <td>PZ</td> </tr> <tr> <td>VL1166A0</td> <td>RACCORDO A L BAM-BB6</td> <td>1.000</td> <td>PZ</td> </tr> <tr> <td>VL1174C0</td> <td>UGELLO CALIBRATO D1.2 MM</td> <td>1.000</td> <td>PZ</td> </tr> <tr> <td>VL1191A0</td> <td>DISTRIBUTOR E USCITA LAVAGGIO ON</td> <td>1.000</td> <td>PZ</td> </tr> <tr> <td>VM2172A0</td> <td>CLIP BLOCCAGGIO POMPA CON CIRCUITO</td> <td>2.000</td> <td>PZ</td> </tr> </tbody> </table>	Code	Description	Qty	UOM	VI1220A1	VITE AUTOFIL. 4.2X11 TCS+ MARUTEX	4.000	PZ	VL1019A0	POMPA DETERGENTE VIBRAZIONE	1.000	PZ	VL1047A1	PORTAGOMM A D6 CODOLO D8	1.000	PZ	VL1054B0	DISTRIBUTOR E INGRESSI LAVAGGIO ON	1.000	PZ	VL1102A1	FILTRO IN LINEA DET. + VNR BARBED 6 MM	1.000	PZ	VL1127A1	RACCORDO A T BARBED 6	1.000	PZ	VL1128A1	VALVOLA VNR BARBED D6	2.000	PZ	VL1165A0	RACCORDO DRITTO BAM-BB6	1.000	PZ	VL1166A0	RACCORDO A L BAM-BB6	1.000	PZ	VL1174C0	UGELLO CALIBRATO D1.2 MM	1.000	PZ	VL1191A0	DISTRIBUTOR E USCITA LAVAGGIO ON	1.000	PZ	VM2172A0	CLIP BLOCCAGGIO POMPA CON CIRCUITO	2.000	PZ
			Code	Description	Qty	UOM																																																			
VI1220A1	VITE AUTOFIL. 4.2X11 TCS+ MARUTEX	4.000	PZ																																																						
VL1019A0	POMPA DETERGENTE VIBRAZIONE	1.000	PZ																																																						
VL1047A1	PORTAGOMM A D6 CODOLO D8	1.000	PZ																																																						
VL1054B0	DISTRIBUTOR E INGRESSI LAVAGGIO ON	1.000	PZ																																																						
VL1102A1	FILTRO IN LINEA DET. + VNR BARBED 6 MM	1.000	PZ																																																						
VL1127A1	RACCORDO A T BARBED 6	1.000	PZ																																																						
VL1128A1	VALVOLA VNR BARBED D6	2.000	PZ																																																						
VL1165A0	RACCORDO DRITTO BAM-BB6	1.000	PZ																																																						
VL1166A0	RACCORDO A L BAM-BB6	1.000	PZ																																																						
VL1174C0	UGELLO CALIBRATO D1.2 MM	1.000	PZ																																																						
VL1191A0	DISTRIBUTOR E USCITA LAVAGGIO ON	1.000	PZ																																																						
VM2172A0	CLIP BLOCCAGGIO POMPA CON CIRCUITO	2.000	PZ																																																						
KVL1198A	MM EU HOOD CLEANING SYSTEM KIT	<table border="1"> <thead> <tr> <th>Code</th> <th>Description</th> <th>Qty</th> <th>UOM</th> </tr> </thead> <tbody> <tr> <td>0H2213A1</td> <td>LAMIERA IMPIANTO IDRICO CAPP</td> <td>1.000</td> <td>PZ</td> </tr> <tr> <td>EL1346A0</td> <td>CLIP BLOCCA PINZETTA RACCORDI D10 TIERRE</td> <td>2.000</td> <td>PZ</td> </tr> <tr> <td>EL1440A0</td> <td>ELETTRORVALV OLA H2O AUTOPULENT E BAF EU</td> <td>2.000</td> <td>PZ</td> </tr> <tr> <td>GN1526A0</td> <td>O-RING D.INT6.9 SP1.8</td> <td>5.000</td> <td>PZ</td> </tr> <tr> <td>RC1018A0</td> <td>FASCETTA ELASTICA D12 ZINCATA</td> <td>1.000</td> <td>PZ</td> </tr> </tbody> </table>	Code	Description	Qty	UOM	0H2213A1	LAMIERA IMPIANTO IDRICO CAPP	1.000	PZ	EL1346A0	CLIP BLOCCA PINZETTA RACCORDI D10 TIERRE	2.000	PZ	EL1440A0	ELETTRORVALV OLA H2O AUTOPULENT E BAF EU	2.000	PZ	GN1526A0	O-RING D.INT6.9 SP1.8	5.000	PZ	RC1018A0	FASCETTA ELASTICA D12 ZINCATA	1.000	PZ																															
Code	Description	Qty	UOM																																																						
0H2213A1	LAMIERA IMPIANTO IDRICO CAPP	1.000	PZ																																																						
EL1346A0	CLIP BLOCCA PINZETTA RACCORDI D10 TIERRE	2.000	PZ																																																						
EL1440A0	ELETTRORVALV OLA H2O AUTOPULENT E BAF EU	2.000	PZ																																																						
GN1526A0	O-RING D.INT6.9 SP1.8	5.000	PZ																																																						
RC1018A0	FASCETTA ELASTICA D12 ZINCATA	1.000	PZ																																																						

COMPONENT			SPARE PART																																																																																						
Code	Description	Image	Code	Description	Kit components																																																																																				
EL1440A	ELETTRIVALVOLA H2O AUTOPULENTE BAF EU		KVL1198A	MM EU HOOD CLEANING SYSTEM KIT	<table border="1"> <thead> <tr> <th>Code</th> <th>Description</th> <th>Qty</th> <th>UOM</th> </tr> </thead> <tbody> <tr> <td>RC1019A0</td> <td>FASCETTA ELASTICA D10 ZINCATA</td> <td>14.000</td> <td>PZ</td> </tr> <tr> <td>RC1131A0</td> <td>FASCETTA 200X2.6 BIANCO</td> <td>1.000</td> <td>PZ</td> </tr> <tr> <td>RC1242A0</td> <td>TERMINALE CHIUSO D10</td> <td>2.000</td> <td>PZ</td> </tr> <tr> <td>RC1414A1</td> <td>FASCETTA STRINGITUBO A SCATTO D11.5-12.5</td> <td>5.000</td> <td>PZ</td> </tr> <tr> <td>TB2821A0</td> <td>TB2820A-L=40 MM EPDM NER</td> <td>4.000</td> <td>PZ</td> </tr> <tr> <td>TB2994A0</td> <td>TB2820A-TUB O EPDM NERO 1000MM</td> <td>2.000</td> <td>PZ</td> </tr> <tr> <td>TB3252A0</td> <td>TB3132A-L=23 0MM EPDM BIANCO BLU</td> <td>2.000</td> <td>PZ</td> </tr> <tr> <td>TB3614A0</td> <td>TB2820A-L=96 MM NERO EPD</td> <td>1.000</td> <td>PZ</td> </tr> <tr> <td>VI1220A1</td> <td>VITE AUTOFIL. 4.2X11 TCS+ MARUTEX</td> <td>3.000</td> <td>PZ</td> </tr> <tr> <td>VI2070A0</td> <td>VITE AUTOFIL 40X8 TCB+ SHEETTRACS</td> <td>2.000</td> <td>PZ</td> </tr> <tr> <td>VL1019A0</td> <td>POMPA DETERGENTE VIBRAZIONE</td> <td>1.000</td> <td>PZ</td> </tr> <tr> <td>VL1047A1</td> <td>PORTAGOMM A D6 CODOLO D8</td> <td>2.000</td> <td>PZ</td> </tr> <tr> <td>VL1054B0</td> <td>DISTRIBUTOR E INGRESSI LAVAGGIO ON</td> <td>1.000</td> <td>PZ</td> </tr> <tr> <td>VL1102A1</td> <td>FILTRO IN LINEA DET. + VNR BARBED 6 MM</td> <td>1.000</td> <td>PZ</td> </tr> <tr> <td>VL1127A1</td> <td>RACCORDO A T BARBED 6</td> <td>1.000</td> <td>PZ</td> </tr> <tr> <td>VL1128A1</td> <td>VALVOLA VNR BARBED D6</td> <td>1.000</td> <td>PZ</td> </tr> <tr> <td>VL1165A0</td> <td>RACCORDO DRITTO BAM-BB6</td> <td>1.000</td> <td>PZ</td> </tr> <tr> <td>VL1166A0</td> <td>RACCORDO A L BAM-BB6</td> <td>2.000</td> <td>PZ</td> </tr> <tr> <td>VL1174C0</td> <td>UGELLO CALIBRATO D1.2 MM</td> <td>1.000</td> <td>PZ</td> </tr> <tr> <td>VL1191A0</td> <td>DISTRIBUTOR E USCITA LAVAGGIO ON</td> <td>1.000</td> <td>PZ</td> </tr> </tbody> </table>	Code	Description	Qty	UOM	RC1019A0	FASCETTA ELASTICA D10 ZINCATA	14.000	PZ	RC1131A0	FASCETTA 200X2.6 BIANCO	1.000	PZ	RC1242A0	TERMINALE CHIUSO D10	2.000	PZ	RC1414A1	FASCETTA STRINGITUBO A SCATTO D11.5-12.5	5.000	PZ	TB2821A0	TB2820A-L=40 MM EPDM NER	4.000	PZ	TB2994A0	TB2820A-TUB O EPDM NERO 1000MM	2.000	PZ	TB3252A0	TB3132A-L=23 0MM EPDM BIANCO BLU	2.000	PZ	TB3614A0	TB2820A-L=96 MM NERO EPD	1.000	PZ	VI1220A1	VITE AUTOFIL. 4.2X11 TCS+ MARUTEX	3.000	PZ	VI2070A0	VITE AUTOFIL 40X8 TCB+ SHEETTRACS	2.000	PZ	VL1019A0	POMPA DETERGENTE VIBRAZIONE	1.000	PZ	VL1047A1	PORTAGOMM A D6 CODOLO D8	2.000	PZ	VL1054B0	DISTRIBUTOR E INGRESSI LAVAGGIO ON	1.000	PZ	VL1102A1	FILTRO IN LINEA DET. + VNR BARBED 6 MM	1.000	PZ	VL1127A1	RACCORDO A T BARBED 6	1.000	PZ	VL1128A1	VALVOLA VNR BARBED D6	1.000	PZ	VL1165A0	RACCORDO DRITTO BAM-BB6	1.000	PZ	VL1166A0	RACCORDO A L BAM-BB6	2.000	PZ	VL1174C0	UGELLO CALIBRATO D1.2 MM	1.000	PZ	VL1191A0	DISTRIBUTOR E USCITA LAVAGGIO ON	1.000	PZ
Code	Description	Qty	UOM																																																																																						
RC1019A0	FASCETTA ELASTICA D10 ZINCATA	14.000	PZ																																																																																						
RC1131A0	FASCETTA 200X2.6 BIANCO	1.000	PZ																																																																																						
RC1242A0	TERMINALE CHIUSO D10	2.000	PZ																																																																																						
RC1414A1	FASCETTA STRINGITUBO A SCATTO D11.5-12.5	5.000	PZ																																																																																						
TB2821A0	TB2820A-L=40 MM EPDM NER	4.000	PZ																																																																																						
TB2994A0	TB2820A-TUB O EPDM NERO 1000MM	2.000	PZ																																																																																						
TB3252A0	TB3132A-L=23 0MM EPDM BIANCO BLU	2.000	PZ																																																																																						
TB3614A0	TB2820A-L=96 MM NERO EPD	1.000	PZ																																																																																						
VI1220A1	VITE AUTOFIL. 4.2X11 TCS+ MARUTEX	3.000	PZ																																																																																						
VI2070A0	VITE AUTOFIL 40X8 TCB+ SHEETTRACS	2.000	PZ																																																																																						
VL1019A0	POMPA DETERGENTE VIBRAZIONE	1.000	PZ																																																																																						
VL1047A1	PORTAGOMM A D6 CODOLO D8	2.000	PZ																																																																																						
VL1054B0	DISTRIBUTOR E INGRESSI LAVAGGIO ON	1.000	PZ																																																																																						
VL1102A1	FILTRO IN LINEA DET. + VNR BARBED 6 MM	1.000	PZ																																																																																						
VL1127A1	RACCORDO A T BARBED 6	1.000	PZ																																																																																						
VL1128A1	VALVOLA VNR BARBED D6	1.000	PZ																																																																																						
VL1165A0	RACCORDO DRITTO BAM-BB6	1.000	PZ																																																																																						
VL1166A0	RACCORDO A L BAM-BB6	2.000	PZ																																																																																						
VL1174C0	UGELLO CALIBRATO D1.2 MM	1.000	PZ																																																																																						
VL1191A0	DISTRIBUTOR E USCITA LAVAGGIO ON	1.000	PZ																																																																																						

COMPONENT			SPARE PART																																																											
Code	Description	Image	Code	Description	Kit components																																																									
EL1440A	ELETTRORVALVOLA H2O AUTOPULENTE BAF EU		KVL1198A	MM EU HOOD CLEANING SYSTEM KIT	<table border="1"> <thead> <tr> <th>Code</th> <th>Description</th> <th>Qty</th> <th>UOM</th> </tr> </thead> <tbody> <tr> <td>VL1214A0</td> <td>VALVOLA VNR BB6-BAIONET TA</td> <td>1.000</td> <td>PZ</td> </tr> <tr> <td>VM1605A0</td> <td>CLIP TWIST LOCK DIAM. 10,2-12,7 MM</td> <td>2.000</td> <td>PZ</td> </tr> <tr> <td>VM2172A0</td> <td>CLIP BLOCCAGGIO POMPA CON CIRCUITO</td> <td>3.000</td> <td>PZ</td> </tr> </tbody> </table>	Code	Description	Qty	UOM	VL1214A0	VALVOLA VNR BB6-BAIONET TA	1.000	PZ	VM1605A0	CLIP TWIST LOCK DIAM. 10,2-12,7 MM	2.000	PZ	VM2172A0	CLIP BLOCCAGGIO POMPA CON CIRCUITO	3.000	PZ																																									
			Code	Description	Qty	UOM																																																								
VL1214A0	VALVOLA VNR BB6-BAIONET TA	1.000	PZ																																																											
VM1605A0	CLIP TWIST LOCK DIAM. 10,2-12,7 MM	2.000	PZ																																																											
VM2172A0	CLIP BLOCCAGGIO POMPA CON CIRCUITO	3.000	PZ																																																											
KVL1187A	3 ROTOR ARMS PLUS EU CLEANING SYSTEM KIT	<table border="1"> <thead> <tr> <th>Code</th> <th>Description</th> <th>Qty</th> <th>UOM</th> </tr> </thead> <tbody> <tr> <td>0H2354A2</td> <td>LAMIERA IMPIANTO LAVAGGIO PLUS XEVC-XEVL</td> <td>1.000</td> <td>PZ</td> </tr> <tr> <td>EL1346A0</td> <td>CLIP BLOCCA PINZETTA RACCORDI D10 TIERRE</td> <td>2.000</td> <td>PZ</td> </tr> <tr> <td>EL1440A0</td> <td>ELETTRORVALV OLA H2O AUTOPULENT E BAF EU</td> <td>4.000</td> <td>PZ</td> </tr> <tr> <td>GN1526A0</td> <td>O-RING D.INT6,9 SP1,8</td> <td>9.000</td> <td>PZ</td> </tr> <tr> <td>RC1018A0</td> <td>FASCETTA ELASTICA D12 ZINCATA</td> <td>11.000</td> <td>PZ</td> </tr> <tr> <td>RC1019A0</td> <td>FASCETTA ELASTICA D10 ZINCATA</td> <td>14.000</td> <td>PZ</td> </tr> <tr> <td>RC1130A0</td> <td>FASCETTA 130X2,6</td> <td>1.000</td> <td>PZ</td> </tr> <tr> <td>RC1131A0</td> <td>FASCETTA 200X2,6 BIANC</td> <td>3.000</td> <td>PZ</td> </tr> <tr> <td>RC1242A0</td> <td>TERMINALE CHIUSO D10</td> <td>2.000</td> <td>PZ</td> </tr> <tr> <td>RC1356A0</td> <td>RACCORDO DRITTO FIL. FEMM 8X1/4 BSP</td> <td>1.000</td> <td>PZ</td> </tr> <tr> <td>RC1414A1</td> <td>FASCETTA STRINGITUBO A SCATTO D11,5-12,5</td> <td>1.000</td> <td>PZ</td> </tr> <tr> <td>TB2652A0</td> <td>TB3132A-L750 MM BIANCO BLU EPDM</td> <td>1.000</td> <td>PZ</td> </tr> <tr> <td>TB2677A0</td> <td>TB2820A-TUB O TANICA DET-FDET L1300MM</td> <td>1.000</td> <td>PZ</td> </tr> <tr> <td>TB2821A0</td> <td>TB2820A-L=40 MM EPDM NER</td> <td>4.000</td> <td>PZ</td> </tr> </tbody> </table>	Code	Description	Qty	UOM	0H2354A2	LAMIERA IMPIANTO LAVAGGIO PLUS XEVC-XEVL	1.000	PZ	EL1346A0	CLIP BLOCCA PINZETTA RACCORDI D10 TIERRE	2.000	PZ	EL1440A0	ELETTRORVALV OLA H2O AUTOPULENT E BAF EU	4.000	PZ	GN1526A0	O-RING D.INT6,9 SP1,8	9.000	PZ	RC1018A0	FASCETTA ELASTICA D12 ZINCATA	11.000	PZ	RC1019A0	FASCETTA ELASTICA D10 ZINCATA	14.000	PZ	RC1130A0	FASCETTA 130X2,6	1.000	PZ	RC1131A0	FASCETTA 200X2,6 BIANC	3.000	PZ	RC1242A0	TERMINALE CHIUSO D10	2.000	PZ	RC1356A0	RACCORDO DRITTO FIL. FEMM 8X1/4 BSP	1.000	PZ	RC1414A1	FASCETTA STRINGITUBO A SCATTO D11,5-12,5	1.000	PZ	TB2652A0	TB3132A-L750 MM BIANCO BLU EPDM	1.000	PZ	TB2677A0	TB2820A-TUB O TANICA DET-FDET L1300MM	1.000	PZ	TB2821A0	TB2820A-L=40 MM EPDM NER	4.000	PZ
Code	Description	Qty	UOM																																																											
0H2354A2	LAMIERA IMPIANTO LAVAGGIO PLUS XEVC-XEVL	1.000	PZ																																																											
EL1346A0	CLIP BLOCCA PINZETTA RACCORDI D10 TIERRE	2.000	PZ																																																											
EL1440A0	ELETTRORVALV OLA H2O AUTOPULENT E BAF EU	4.000	PZ																																																											
GN1526A0	O-RING D.INT6,9 SP1,8	9.000	PZ																																																											
RC1018A0	FASCETTA ELASTICA D12 ZINCATA	11.000	PZ																																																											
RC1019A0	FASCETTA ELASTICA D10 ZINCATA	14.000	PZ																																																											
RC1130A0	FASCETTA 130X2,6	1.000	PZ																																																											
RC1131A0	FASCETTA 200X2,6 BIANC	3.000	PZ																																																											
RC1242A0	TERMINALE CHIUSO D10	2.000	PZ																																																											
RC1356A0	RACCORDO DRITTO FIL. FEMM 8X1/4 BSP	1.000	PZ																																																											
RC1414A1	FASCETTA STRINGITUBO A SCATTO D11,5-12,5	1.000	PZ																																																											
TB2652A0	TB3132A-L750 MM BIANCO BLU EPDM	1.000	PZ																																																											
TB2677A0	TB2820A-TUB O TANICA DET-FDET L1300MM	1.000	PZ																																																											
TB2821A0	TB2820A-L=40 MM EPDM NER	4.000	PZ																																																											

COMPONENT			SPARE PART																																																																														
Code	Description	Image	Code	Description	Kit components																																																																												
EL1440A	ELETTRIVALVOLA H2O AUTOPULENTE BAF EU		KVL1187A	3 ROTOR ARMS PLUS EU CLEANING SYSTEM KIT	<table border="1"> <thead> <tr> <th>Code</th> <th>Description</th> <th>Qty</th> <th>UOM</th> </tr> </thead> <tbody> <tr> <td>TB3004A0</td> <td>TB2820A-L=57 0MM EPDM NERO</td> <td>2.000</td> <td>PZ</td> </tr> <tr> <td>TB3024C0</td> <td>TB3132A-TUB O BLU 6X12 L=55MM</td> <td>3.000</td> <td>PZ</td> </tr> <tr> <td>TB3226A0</td> <td>TB2820A-L110 MM COLLEGAMEN TO TANICA-LA</td> <td>1.000</td> <td>PZ</td> </tr> <tr> <td>TB3440A0</td> <td>TB3132A-L=10 50MM EPDM BIANCO-BLU</td> <td>1.000</td> <td>PZ</td> </tr> <tr> <td>TB3614A0</td> <td>TB2820A-L=96 MM NERO EPD</td> <td>1.000</td> <td>PZ</td> </tr> <tr> <td>VI1220A1</td> <td>VITE AUTOFIL. 4.2X11 TCS+ MARUTEX</td> <td>1.000</td> <td>PZ</td> </tr> <tr> <td>VL1019A0</td> <td>POMPA DETERGENTE VIBRAZIONE</td> <td>1.000</td> <td>PZ</td> </tr> <tr> <td>VL1047A1</td> <td>PORTAGOMM A D6 CODOLO D8</td> <td>1.000</td> <td>PZ</td> </tr> <tr> <td>VL1102A1</td> <td>FILTRO IN LINEA DET. + VNR BARBED 6 MM</td> <td>1.000</td> <td>PZ</td> </tr> <tr> <td>VL1127A1</td> <td>RACCORDO A T BARBED 6</td> <td>2.000</td> <td>PZ</td> </tr> <tr> <td>VL1128A1</td> <td>VALVOLA VNR BARBED D6</td> <td>2.000</td> <td>PZ</td> </tr> <tr> <td>VL1166A0</td> <td>RACCORDO A L BAM-BB6</td> <td>4.000</td> <td>PZ</td> </tr> <tr> <td>VL1167A2</td> <td>FLOW RESTRICTOR 3 GIRANTI GN21 B-B</td> <td>1.000</td> <td>PZ</td> </tr> <tr> <td>VL1174C0</td> <td>UGELLO CALIBRATO D1.2 MM</td> <td>1.000</td> <td>PZ</td> </tr> <tr> <td>VL1186A0</td> <td>DISTRIBUTOR E LAVAGGIO PLUS 3 VIE UGELLO</td> <td>1.000</td> <td>PZ</td> </tr> <tr> <td>VL1190A0</td> <td>DISTRIBUTOR E INGRESSI LAVAGGIO PLUS</td> <td>1.000</td> <td>PZ</td> </tr> <tr> <td>VL1214A0</td> <td>VALVOLA VNR BB6-BAIONET TA</td> <td>1.000</td> <td>PZ</td> </tr> <tr> <td>VL1398A0</td> <td>PRESSOSTAT O N.O. 1/4 M CI</td> <td>1.000</td> <td>PZ</td> </tr> </tbody> </table>	Code	Description	Qty	UOM	TB3004A0	TB2820A-L=57 0MM EPDM NERO	2.000	PZ	TB3024C0	TB3132A-TUB O BLU 6X12 L=55MM	3.000	PZ	TB3226A0	TB2820A-L110 MM COLLEGAMEN TO TANICA-LA	1.000	PZ	TB3440A0	TB3132A-L=10 50MM EPDM BIANCO-BLU	1.000	PZ	TB3614A0	TB2820A-L=96 MM NERO EPD	1.000	PZ	VI1220A1	VITE AUTOFIL. 4.2X11 TCS+ MARUTEX	1.000	PZ	VL1019A0	POMPA DETERGENTE VIBRAZIONE	1.000	PZ	VL1047A1	PORTAGOMM A D6 CODOLO D8	1.000	PZ	VL1102A1	FILTRO IN LINEA DET. + VNR BARBED 6 MM	1.000	PZ	VL1127A1	RACCORDO A T BARBED 6	2.000	PZ	VL1128A1	VALVOLA VNR BARBED D6	2.000	PZ	VL1166A0	RACCORDO A L BAM-BB6	4.000	PZ	VL1167A2	FLOW RESTRICTOR 3 GIRANTI GN21 B-B	1.000	PZ	VL1174C0	UGELLO CALIBRATO D1.2 MM	1.000	PZ	VL1186A0	DISTRIBUTOR E LAVAGGIO PLUS 3 VIE UGELLO	1.000	PZ	VL1190A0	DISTRIBUTOR E INGRESSI LAVAGGIO PLUS	1.000	PZ	VL1214A0	VALVOLA VNR BB6-BAIONET TA	1.000	PZ	VL1398A0	PRESSOSTAT O N.O. 1/4 M CI	1.000	PZ
Code	Description	Qty	UOM																																																																														
TB3004A0	TB2820A-L=57 0MM EPDM NERO	2.000	PZ																																																																														
TB3024C0	TB3132A-TUB O BLU 6X12 L=55MM	3.000	PZ																																																																														
TB3226A0	TB2820A-L110 MM COLLEGAMEN TO TANICA-LA	1.000	PZ																																																																														
TB3440A0	TB3132A-L=10 50MM EPDM BIANCO-BLU	1.000	PZ																																																																														
TB3614A0	TB2820A-L=96 MM NERO EPD	1.000	PZ																																																																														
VI1220A1	VITE AUTOFIL. 4.2X11 TCS+ MARUTEX	1.000	PZ																																																																														
VL1019A0	POMPA DETERGENTE VIBRAZIONE	1.000	PZ																																																																														
VL1047A1	PORTAGOMM A D6 CODOLO D8	1.000	PZ																																																																														
VL1102A1	FILTRO IN LINEA DET. + VNR BARBED 6 MM	1.000	PZ																																																																														
VL1127A1	RACCORDO A T BARBED 6	2.000	PZ																																																																														
VL1128A1	VALVOLA VNR BARBED D6	2.000	PZ																																																																														
VL1166A0	RACCORDO A L BAM-BB6	4.000	PZ																																																																														
VL1167A2	FLOW RESTRICTOR 3 GIRANTI GN21 B-B	1.000	PZ																																																																														
VL1174C0	UGELLO CALIBRATO D1.2 MM	1.000	PZ																																																																														
VL1186A0	DISTRIBUTOR E LAVAGGIO PLUS 3 VIE UGELLO	1.000	PZ																																																																														
VL1190A0	DISTRIBUTOR E INGRESSI LAVAGGIO PLUS	1.000	PZ																																																																														
VL1214A0	VALVOLA VNR BB6-BAIONET TA	1.000	PZ																																																																														
VL1398A0	PRESSOSTAT O N.O. 1/4 M CI	1.000	PZ																																																																														

COMPONENT			SPARE PART																																																															
Code	Description	Image	Code	Description	Kit components																																																													
EL1440A	ELETTRIVALVOLA H2O AUTOPULENTE BAF EU		KVL1187A	3 ROTOR ARMS PLUS EU CLEANING SYSTEM KIT	<table border="1"> <thead> <tr> <th>Code</th> <th>Description</th> <th>Qty</th> <th>UOM</th> </tr> </thead> <tbody> <tr> <td>VM1605A0</td> <td>CLIP TWIST LOCK DIAM. 10,2-12,7 MM</td> <td>3.000</td> <td>PZ</td> </tr> <tr> <td>VM2172A0</td> <td>CLIP BLOCCAGGIO POMPA CON CIRCUITO</td> <td>5.000</td> <td>PZ</td> </tr> </tbody> </table>	Code	Description	Qty	UOM	VM1605A0	CLIP TWIST LOCK DIAM. 10,2-12,7 MM	3.000	PZ	VM2172A0	CLIP BLOCCAGGIO POMPA CON CIRCUITO	5.000	PZ																																																	
			Code	Description	Qty	UOM																																																												
VM1605A0	CLIP TWIST LOCK DIAM. 10,2-12,7 MM	3.000	PZ																																																															
VM2172A0	CLIP BLOCCAGGIO POMPA CON CIRCUITO	5.000	PZ																																																															
KVL1184A	2 ROTOR ARMS PLUS EU CLEANING SYSTEM KIT	<table border="1"> <thead> <tr> <th>Code</th> <th>Description</th> <th>Qty</th> <th>UOM</th> </tr> </thead> <tbody> <tr> <td>0H2354A2</td> <td>LAMIERA IMPIANTO LAVAGGIO PLUS XEVC-XEVL</td> <td>1.000</td> <td>PZ</td> </tr> <tr> <td>EL1346A0</td> <td>CLIP BLOCCA PINZETTA RACCORDI D10 TIERRE</td> <td>2.000</td> <td>PZ</td> </tr> <tr> <td>EL1440A0</td> <td>ELETTRIVALV OLA H2O AUTOPULENT E BAF EU</td> <td>4.000</td> <td>PZ</td> </tr> <tr> <td>GN1526A0</td> <td>O-RING D.INT6,9 SP1.8</td> <td>9.000</td> <td>PZ</td> </tr> <tr> <td>RC1018A0</td> <td>FASCETTA ELASTICA D12 ZINCATA</td> <td>2.000</td> <td>PZ</td> </tr> <tr> <td>RC1019A0</td> <td>FASCETTA ELASTICA D10 ZINCATA</td> <td>13.000</td> <td>PZ</td> </tr> <tr> <td>RC1130A0</td> <td>FASCETTA 130X2,6</td> <td>1.000</td> <td>PZ</td> </tr> <tr> <td>RC1131A0</td> <td>FASCETTA 200X2,6 BIANC</td> <td>3.000</td> <td>PZ</td> </tr> <tr> <td>RC1242A0</td> <td>TERMINALE CHIUSO D10</td> <td>2.000</td> <td>PZ</td> </tr> <tr> <td>RC1356A0</td> <td>RACCORDO DRITTO FIL. FEMM 8X1/4 BSP</td> <td>1.000</td> <td>PZ</td> </tr> <tr> <td>RC1414A1</td> <td>FASCETTA STRINGITUBO A SCATTO D11.5-12.5</td> <td>1.000</td> <td>PZ</td> </tr> <tr> <td>TB2821A0</td> <td>TB2820A-L=40 MM EPDM NER</td> <td>4.000</td> <td>PZ</td> </tr> <tr> <td>TB2994A0</td> <td>TB2820A-TUB O EPDM NERO 1000MM</td> <td>1.000</td> <td>PZ</td> </tr> <tr> <td>TB3004A0</td> <td>TB2820A-L=57 0MM EPDM NERO</td> <td>2.000</td> <td>PZ</td> </tr> <tr> <td>TB3005B0</td> <td>TB3132A-L=55 0MM EPDM BIANCO BLU</td> <td>1.000</td> <td>PZ</td> </tr> </tbody> </table>	Code	Description	Qty	UOM	0H2354A2	LAMIERA IMPIANTO LAVAGGIO PLUS XEVC-XEVL	1.000	PZ	EL1346A0	CLIP BLOCCA PINZETTA RACCORDI D10 TIERRE	2.000	PZ	EL1440A0	ELETTRIVALV OLA H2O AUTOPULENT E BAF EU	4.000	PZ	GN1526A0	O-RING D.INT6,9 SP1.8	9.000	PZ	RC1018A0	FASCETTA ELASTICA D12 ZINCATA	2.000	PZ	RC1019A0	FASCETTA ELASTICA D10 ZINCATA	13.000	PZ	RC1130A0	FASCETTA 130X2,6	1.000	PZ	RC1131A0	FASCETTA 200X2,6 BIANC	3.000	PZ	RC1242A0	TERMINALE CHIUSO D10	2.000	PZ	RC1356A0	RACCORDO DRITTO FIL. FEMM 8X1/4 BSP	1.000	PZ	RC1414A1	FASCETTA STRINGITUBO A SCATTO D11.5-12.5	1.000	PZ	TB2821A0	TB2820A-L=40 MM EPDM NER	4.000	PZ	TB2994A0	TB2820A-TUB O EPDM NERO 1000MM	1.000	PZ	TB3004A0	TB2820A-L=57 0MM EPDM NERO	2.000	PZ	TB3005B0	TB3132A-L=55 0MM EPDM BIANCO BLU	1.000	PZ
Code	Description	Qty	UOM																																																															
0H2354A2	LAMIERA IMPIANTO LAVAGGIO PLUS XEVC-XEVL	1.000	PZ																																																															
EL1346A0	CLIP BLOCCA PINZETTA RACCORDI D10 TIERRE	2.000	PZ																																																															
EL1440A0	ELETTRIVALV OLA H2O AUTOPULENT E BAF EU	4.000	PZ																																																															
GN1526A0	O-RING D.INT6,9 SP1.8	9.000	PZ																																																															
RC1018A0	FASCETTA ELASTICA D12 ZINCATA	2.000	PZ																																																															
RC1019A0	FASCETTA ELASTICA D10 ZINCATA	13.000	PZ																																																															
RC1130A0	FASCETTA 130X2,6	1.000	PZ																																																															
RC1131A0	FASCETTA 200X2,6 BIANC	3.000	PZ																																																															
RC1242A0	TERMINALE CHIUSO D10	2.000	PZ																																																															
RC1356A0	RACCORDO DRITTO FIL. FEMM 8X1/4 BSP	1.000	PZ																																																															
RC1414A1	FASCETTA STRINGITUBO A SCATTO D11.5-12.5	1.000	PZ																																																															
TB2821A0	TB2820A-L=40 MM EPDM NER	4.000	PZ																																																															
TB2994A0	TB2820A-TUB O EPDM NERO 1000MM	1.000	PZ																																																															
TB3004A0	TB2820A-L=57 0MM EPDM NERO	2.000	PZ																																																															
TB3005B0	TB3132A-L=55 0MM EPDM BIANCO BLU	1.000	PZ																																																															



COMPONENT			SPARE PART																																																																													
Code	Description	Image	Code	Description	Kit components																																																																											
EL1440A	ELETTRORVALVOLA H2O AUTOPULENTE BAF EU		KVL1184A	2 ROTOR ARMS PLUS EU CLEANING SYSTEM KIT	<table border="1"> <thead> <tr> <th>Code</th> <th>Description</th> <th>Qty</th> <th>UOM</th> </tr> </thead> <tbody> <tr> <td>TB3440A0</td> <td>TB3132A-L=10 50MM EPDM BIANCO-BLU</td> <td>1.000</td> <td>PZ</td> </tr> <tr> <td>TB3614A0</td> <td>TB2820A-L=96 MM NERO EPD</td> <td>1.000</td> <td>PZ</td> </tr> <tr> <td>VI1220A1</td> <td>VITE AUTOFIL. 4.2X11 TCS+ MARUTEX</td> <td>1.000</td> <td>PZ</td> </tr> <tr> <td>VL1019A0</td> <td>POMPA DETERGENTE VIBRAZIONE</td> <td>1.000</td> <td>PZ</td> </tr> <tr> <td>VL1047A1</td> <td>PORTAGOMM A D6 CODOLO D8</td> <td>1.000</td> <td>PZ</td> </tr> <tr> <td>VL1102A1</td> <td>FILTRO IN LINEA DET. + VNR BARBED 6 MM</td> <td>1.000</td> <td>PZ</td> </tr> <tr> <td>VL1128A1</td> <td>VALVOLA VNR BARBED D6</td> <td>1.000</td> <td>PZ</td> </tr> <tr> <td>VL1166A0</td> <td>RACCORDO A L BAM-BB6</td> <td>4.000</td> <td>PZ</td> </tr> <tr> <td>VL1174C0</td> <td>UGELLO CALIBRATO D1.2 MM</td> <td>1.000</td> <td>PZ</td> </tr> <tr> <td>VL1186A0</td> <td>DISTRIBUTOR E LAVAGGIO PLUS 3 VIE UGELLO</td> <td>1.000</td> <td>PZ</td> </tr> <tr> <td>VL1190A0</td> <td>DISTRIBUTOR E INGRESSI LAVAGGIO PLUS</td> <td>1.000</td> <td>PZ</td> </tr> <tr> <td>VL1214A0</td> <td>VALVOLA VNR BB6-BAIONET TA</td> <td>1.000</td> <td>PZ</td> </tr> <tr> <td>VL1398A0</td> <td>PRESSOSTAT O.N.O. 1/4 M CI</td> <td>1.000</td> <td>PZ</td> </tr> <tr> <td>VM1605A0</td> <td>CLIP TWIST LOCK DIAM. 10,2-12,7 MM</td> <td>3.000</td> <td>PZ</td> </tr> <tr> <td>VM2172A0</td> <td>CLIP BLOCCAGGIO POMPA CON CIRCUITO</td> <td>5.000</td> <td>PZ</td> </tr> </tbody> </table>	Code	Description	Qty	UOM	TB3440A0	TB3132A-L=10 50MM EPDM BIANCO-BLU	1.000	PZ	TB3614A0	TB2820A-L=96 MM NERO EPD	1.000	PZ	VI1220A1	VITE AUTOFIL. 4.2X11 TCS+ MARUTEX	1.000	PZ	VL1019A0	POMPA DETERGENTE VIBRAZIONE	1.000	PZ	VL1047A1	PORTAGOMM A D6 CODOLO D8	1.000	PZ	VL1102A1	FILTRO IN LINEA DET. + VNR BARBED 6 MM	1.000	PZ	VL1128A1	VALVOLA VNR BARBED D6	1.000	PZ	VL1166A0	RACCORDO A L BAM-BB6	4.000	PZ	VL1174C0	UGELLO CALIBRATO D1.2 MM	1.000	PZ	VL1186A0	DISTRIBUTOR E LAVAGGIO PLUS 3 VIE UGELLO	1.000	PZ	VL1190A0	DISTRIBUTOR E INGRESSI LAVAGGIO PLUS	1.000	PZ	VL1214A0	VALVOLA VNR BB6-BAIONET TA	1.000	PZ	VL1398A0	PRESSOSTAT O.N.O. 1/4 M CI	1.000	PZ	VM1605A0	CLIP TWIST LOCK DIAM. 10,2-12,7 MM	3.000	PZ	VM2172A0	CLIP BLOCCAGGIO POMPA CON CIRCUITO	5.000	PZ	KVL1183A	1 ROTOR ARM PLUS CLEANING SYSTEM KIT	<table border="1"> <thead> <tr> <th>Code</th> <th>Description</th> <th>Qty</th> <th>UOM</th> </tr> </thead> <tbody> <tr> <td>0H2354A2</td> <td>LAMIERA IMPIANTO LAVAGGIO PLUS XEVC-XEVL</td> <td>1.000</td> <td>PZ</td> </tr> </tbody> </table>	Code	Description	Qty	UOM	0H2354A2	LAMIERA IMPIANTO LAVAGGIO PLUS XEVC-XEVL	1.000	PZ
			Code	Description	Qty	UOM																																																																										
TB3440A0	TB3132A-L=10 50MM EPDM BIANCO-BLU	1.000	PZ																																																																													
TB3614A0	TB2820A-L=96 MM NERO EPD	1.000	PZ																																																																													
VI1220A1	VITE AUTOFIL. 4.2X11 TCS+ MARUTEX	1.000	PZ																																																																													
VL1019A0	POMPA DETERGENTE VIBRAZIONE	1.000	PZ																																																																													
VL1047A1	PORTAGOMM A D6 CODOLO D8	1.000	PZ																																																																													
VL1102A1	FILTRO IN LINEA DET. + VNR BARBED 6 MM	1.000	PZ																																																																													
VL1128A1	VALVOLA VNR BARBED D6	1.000	PZ																																																																													
VL1166A0	RACCORDO A L BAM-BB6	4.000	PZ																																																																													
VL1174C0	UGELLO CALIBRATO D1.2 MM	1.000	PZ																																																																													
VL1186A0	DISTRIBUTOR E LAVAGGIO PLUS 3 VIE UGELLO	1.000	PZ																																																																													
VL1190A0	DISTRIBUTOR E INGRESSI LAVAGGIO PLUS	1.000	PZ																																																																													
VL1214A0	VALVOLA VNR BB6-BAIONET TA	1.000	PZ																																																																													
VL1398A0	PRESSOSTAT O.N.O. 1/4 M CI	1.000	PZ																																																																													
VM1605A0	CLIP TWIST LOCK DIAM. 10,2-12,7 MM	3.000	PZ																																																																													
VM2172A0	CLIP BLOCCAGGIO POMPA CON CIRCUITO	5.000	PZ																																																																													
Code	Description	Qty	UOM																																																																													
0H2354A2	LAMIERA IMPIANTO LAVAGGIO PLUS XEVC-XEVL	1.000	PZ																																																																													

COMPONENT			SPARE PART																																																																										
Code	Description	Image	Code	Description	Kit components																																																																								
EL1440A	ELETTRORVALVOLA H2O AUTOPULENTE BAF EU		KVL1183A	1 ROTOR ARM PLUS CLEANING SYSTEM KIT	<table border="1"> <thead> <tr> <th>Code</th> <th>Description</th> <th>Qty</th> <th>UOM</th> </tr> </thead> <tbody> <tr> <td>EL1346A0</td> <td>CLIP BLOCCA PINZETTA RACCORDI D10 TIERRE</td> <td>2.000</td> <td>PZ</td> </tr> <tr> <td>EL1440A0</td> <td>ELETTRORVALV OLA H2O AUTOPULENTE E BAF EU</td> <td>3.000</td> <td>PZ</td> </tr> <tr> <td>GN1526A0</td> <td>O-RING D.INT6.9 SP1.8</td> <td>7.000</td> <td>PZ</td> </tr> <tr> <td>RC1018A0</td> <td>FASCETTA ELASTICA D12 ZINCATA</td> <td>1.000</td> <td>PZ</td> </tr> <tr> <td>RC1019A0</td> <td>FASCETTA ELASTICA D10 ZINCATA</td> <td>12.000</td> <td>PZ</td> </tr> <tr> <td>RC1130A0</td> <td>FASCETTA 130X2,6</td> <td>1.000</td> <td>PZ</td> </tr> <tr> <td>RC1131A0</td> <td>FASCETTA 200X2,6 BIANCO</td> <td>2.000</td> <td>PZ</td> </tr> <tr> <td>RC1242A0</td> <td>TERMINALE CHIUSO D10</td> <td>2.000</td> <td>PZ</td> </tr> <tr> <td>RC1356A0</td> <td>RACCORDO DRITTO FIL. FEMM 8X1/4 BSP</td> <td>1.000</td> <td>PZ</td> </tr> <tr> <td>RC1414A1</td> <td>FASCETTA STRINGITUBO A SCATTO D11,5-12,5</td> <td>4.000</td> <td>PZ</td> </tr> <tr> <td>TB2821A0</td> <td>TB2820A-L=40 MM EPDM NER</td> <td>4.000</td> <td>PZ</td> </tr> <tr> <td>TB3004A0</td> <td>TB2820A-L=57 0MM EPDM NERO</td> <td>1.000</td> <td>PZ</td> </tr> <tr> <td>TB3252A0</td> <td>TB3132A-L=23 0MM EPDM BIANCO BLU</td> <td>1.000</td> <td>PZ</td> </tr> <tr> <td>TB3614A0</td> <td>TB2820A-L=96 MM NERO EPD</td> <td>1.000</td> <td>PZ</td> </tr> <tr> <td>TB5360A0</td> <td>TB3132A-TUB O EPDM TELATO BIANCO-BLU 550M</td> <td>1.000</td> <td>PZ</td> </tr> <tr> <td>TB5362A0</td> <td>TB3132A-TUB O EPDM TELATO BIANCO-BLU 230M</td> <td>1.000</td> <td>PZ</td> </tr> <tr> <td>VI1220A1</td> <td>VITE AUTOFIL. 4.2X11 TCS+ MARUTEX</td> <td>1.000</td> <td>PZ</td> </tr> </tbody> </table>	Code	Description	Qty	UOM	EL1346A0	CLIP BLOCCA PINZETTA RACCORDI D10 TIERRE	2.000	PZ	EL1440A0	ELETTRORVALV OLA H2O AUTOPULENTE E BAF EU	3.000	PZ	GN1526A0	O-RING D.INT6.9 SP1.8	7.000	PZ	RC1018A0	FASCETTA ELASTICA D12 ZINCATA	1.000	PZ	RC1019A0	FASCETTA ELASTICA D10 ZINCATA	12.000	PZ	RC1130A0	FASCETTA 130X2,6	1.000	PZ	RC1131A0	FASCETTA 200X2,6 BIANCO	2.000	PZ	RC1242A0	TERMINALE CHIUSO D10	2.000	PZ	RC1356A0	RACCORDO DRITTO FIL. FEMM 8X1/4 BSP	1.000	PZ	RC1414A1	FASCETTA STRINGITUBO A SCATTO D11,5-12,5	4.000	PZ	TB2821A0	TB2820A-L=40 MM EPDM NER	4.000	PZ	TB3004A0	TB2820A-L=57 0MM EPDM NERO	1.000	PZ	TB3252A0	TB3132A-L=23 0MM EPDM BIANCO BLU	1.000	PZ	TB3614A0	TB2820A-L=96 MM NERO EPD	1.000	PZ	TB5360A0	TB3132A-TUB O EPDM TELATO BIANCO-BLU 550M	1.000	PZ	TB5362A0	TB3132A-TUB O EPDM TELATO BIANCO-BLU 230M	1.000	PZ	VI1220A1	VITE AUTOFIL. 4.2X11 TCS+ MARUTEX	1.000	PZ
Code	Description	Qty	UOM																																																																										
EL1346A0	CLIP BLOCCA PINZETTA RACCORDI D10 TIERRE	2.000	PZ																																																																										
EL1440A0	ELETTRORVALV OLA H2O AUTOPULENTE E BAF EU	3.000	PZ																																																																										
GN1526A0	O-RING D.INT6.9 SP1.8	7.000	PZ																																																																										
RC1018A0	FASCETTA ELASTICA D12 ZINCATA	1.000	PZ																																																																										
RC1019A0	FASCETTA ELASTICA D10 ZINCATA	12.000	PZ																																																																										
RC1130A0	FASCETTA 130X2,6	1.000	PZ																																																																										
RC1131A0	FASCETTA 200X2,6 BIANCO	2.000	PZ																																																																										
RC1242A0	TERMINALE CHIUSO D10	2.000	PZ																																																																										
RC1356A0	RACCORDO DRITTO FIL. FEMM 8X1/4 BSP	1.000	PZ																																																																										
RC1414A1	FASCETTA STRINGITUBO A SCATTO D11,5-12,5	4.000	PZ																																																																										
TB2821A0	TB2820A-L=40 MM EPDM NER	4.000	PZ																																																																										
TB3004A0	TB2820A-L=57 0MM EPDM NERO	1.000	PZ																																																																										
TB3252A0	TB3132A-L=23 0MM EPDM BIANCO BLU	1.000	PZ																																																																										
TB3614A0	TB2820A-L=96 MM NERO EPD	1.000	PZ																																																																										
TB5360A0	TB3132A-TUB O EPDM TELATO BIANCO-BLU 550M	1.000	PZ																																																																										
TB5362A0	TB3132A-TUB O EPDM TELATO BIANCO-BLU 230M	1.000	PZ																																																																										
VI1220A1	VITE AUTOFIL. 4.2X11 TCS+ MARUTEX	1.000	PZ																																																																										

COMPONENT			SPARE PART																																																						
Code	Description	Image	Code	Description	Kit components																																																				
EL1440A	ELETTRORVALVOLA H2O AUTOPULENTE BAF EU		KVL1183A	1 ROTOR ARM PLUS CLEANING SYSTEM KIT	<table border="1"> <thead> <tr> <th>Code</th> <th>Description</th> <th>Qty</th> <th>UOM</th> </tr> </thead> <tbody> <tr> <td>VL1019A0</td> <td>POMPA DETERGENTE VIBRAZIONE</td> <td>1.000</td> <td>PZ</td> </tr> <tr> <td>VL1047A1</td> <td>PORTAGOMM A D6 CODOLO D8</td> <td>1.000</td> <td>PZ</td> </tr> <tr> <td>VL1102A1</td> <td>FILTRO IN LINEA DET. + VNR BARBED 6 MM</td> <td>1.000</td> <td>PZ</td> </tr> <tr> <td>VL1128A1</td> <td>VALVOLA VNR BARBED D6</td> <td>1.000</td> <td>PZ</td> </tr> <tr> <td>VL1166A0</td> <td>RACCORDO A L BAM-BB6</td> <td>3.000</td> <td>PZ</td> </tr> <tr> <td>VL1174C0</td> <td>UGELLO CALIBRATO D1.2 MM</td> <td>1.000</td> <td>PZ</td> </tr> <tr> <td>VL1185A0</td> <td>DISTRIBUTOR E LAVAGGIO PLUS 2 VIE UGELLO</td> <td>1.000</td> <td>PZ</td> </tr> <tr> <td>VL1190A0</td> <td>DISTRIBUTOR E INGRESSI LAVAGGIO PLUS</td> <td>1.000</td> <td>PZ</td> </tr> <tr> <td>VL1214A0</td> <td>VALVOLA VNR BB6-BAIONET TA</td> <td>1.000</td> <td>PZ</td> </tr> <tr> <td>VL1398A0</td> <td>PRESSOSTAT O.N.O. 1/4 M CI</td> <td>1.000</td> <td>PZ</td> </tr> <tr> <td>VM1605A0</td> <td>CLIP TWIST LOCK DIAM. 10.2-12.7 MM</td> <td>3.000</td> <td>PZ</td> </tr> <tr> <td>VM2172A0</td> <td>CLIP BLOCCAGGIO POMPA CON CIRCUITO</td> <td>4.000</td> <td>PZ</td> </tr> </tbody> </table>	Code	Description	Qty	UOM	VL1019A0	POMPA DETERGENTE VIBRAZIONE	1.000	PZ	VL1047A1	PORTAGOMM A D6 CODOLO D8	1.000	PZ	VL1102A1	FILTRO IN LINEA DET. + VNR BARBED 6 MM	1.000	PZ	VL1128A1	VALVOLA VNR BARBED D6	1.000	PZ	VL1166A0	RACCORDO A L BAM-BB6	3.000	PZ	VL1174C0	UGELLO CALIBRATO D1.2 MM	1.000	PZ	VL1185A0	DISTRIBUTOR E LAVAGGIO PLUS 2 VIE UGELLO	1.000	PZ	VL1190A0	DISTRIBUTOR E INGRESSI LAVAGGIO PLUS	1.000	PZ	VL1214A0	VALVOLA VNR BB6-BAIONET TA	1.000	PZ	VL1398A0	PRESSOSTAT O.N.O. 1/4 M CI	1.000	PZ	VM1605A0	CLIP TWIST LOCK DIAM. 10.2-12.7 MM	3.000	PZ	VM2172A0	CLIP BLOCCAGGIO POMPA CON CIRCUITO	4.000	PZ
			Code	Description	Qty	UOM																																																			
VL1019A0	POMPA DETERGENTE VIBRAZIONE	1.000	PZ																																																						
VL1047A1	PORTAGOMM A D6 CODOLO D8	1.000	PZ																																																						
VL1102A1	FILTRO IN LINEA DET. + VNR BARBED 6 MM	1.000	PZ																																																						
VL1128A1	VALVOLA VNR BARBED D6	1.000	PZ																																																						
VL1166A0	RACCORDO A L BAM-BB6	3.000	PZ																																																						
VL1174C0	UGELLO CALIBRATO D1.2 MM	1.000	PZ																																																						
VL1185A0	DISTRIBUTOR E LAVAGGIO PLUS 2 VIE UGELLO	1.000	PZ																																																						
VL1190A0	DISTRIBUTOR E INGRESSI LAVAGGIO PLUS	1.000	PZ																																																						
VL1214A0	VALVOLA VNR BB6-BAIONET TA	1.000	PZ																																																						
VL1398A0	PRESSOSTAT O.N.O. 1/4 M CI	1.000	PZ																																																						
VM1605A0	CLIP TWIST LOCK DIAM. 10.2-12.7 MM	3.000	PZ																																																						
VM2172A0	CLIP BLOCCAGGIO POMPA CON CIRCUITO	4.000	PZ																																																						
KVL1182A	ONE 1ROT CLEANING SYSTEM KIT (0311 EXC.)	<table border="1"> <thead> <tr> <th>Code</th> <th>Description</th> <th>Qty</th> <th>UOM</th> </tr> </thead> <tbody> <tr> <td>0H2202A1</td> <td>STAFFA LAVAGGIO ONE CON ELV STEAM</td> <td>1.000</td> <td>PZ</td> </tr> <tr> <td>EL1346A0</td> <td>CLIP BLOCCA PINZETTA RACCORDI D10 TIERRE</td> <td>2.000</td> <td>PZ</td> </tr> <tr> <td>EL1440A0</td> <td>ELETTRORVALV OLA H2O AUTOPULENTE E BAF EU</td> <td>1.000</td> <td>PZ</td> </tr> <tr> <td>GN1526A0</td> <td>O-RING D.INT6.9 SP1.8</td> <td>3.000</td> <td>PZ</td> </tr> </tbody> </table>	Code	Description	Qty	UOM	0H2202A1	STAFFA LAVAGGIO ONE CON ELV STEAM	1.000	PZ	EL1346A0	CLIP BLOCCA PINZETTA RACCORDI D10 TIERRE	2.000	PZ	EL1440A0	ELETTRORVALV OLA H2O AUTOPULENTE E BAF EU	1.000	PZ	GN1526A0	O-RING D.INT6.9 SP1.8	3.000	PZ																																			
Code	Description	Qty	UOM																																																						
0H2202A1	STAFFA LAVAGGIO ONE CON ELV STEAM	1.000	PZ																																																						
EL1346A0	CLIP BLOCCA PINZETTA RACCORDI D10 TIERRE	2.000	PZ																																																						
EL1440A0	ELETTRORVALV OLA H2O AUTOPULENTE E BAF EU	1.000	PZ																																																						
GN1526A0	O-RING D.INT6.9 SP1.8	3.000	PZ																																																						

COMPONENT			SPARE PART																																																																																		
Code	Description	Image	Code	Description	Kit components																																																																																
EL1440A	ELETTRORVALVOLA H2O AUTOPULENTE BAF EU		KVL1182A	ONE 1ROT CLEANING SYSTEM KIT (0311 EXC.)	<table border="1"> <thead> <tr> <th>Code</th> <th>Description</th> <th>Qty</th> <th>UOM</th> </tr> </thead> <tbody> <tr> <td>RC1019A0</td> <td>FASCETTA ELASTICA D10 ZINCATA</td> <td>12.000</td> <td>PZ</td> </tr> <tr> <td>RC1242A0</td> <td>TERMINALE CHIUSO D10</td> <td>2.000</td> <td>PZ</td> </tr> <tr> <td>RC1414A1</td> <td>FASCETTA STRINGITUBO A SCATTO D11,5-12,5</td> <td>4.000</td> <td>PZ</td> </tr> <tr> <td>TB2821A0</td> <td>TB2820A-L=40 MM EPDM NER</td> <td>4.000</td> <td>PZ</td> </tr> <tr> <td>TB3004A0</td> <td>TB2820A-L=57 0MM EPDM NERO</td> <td>1.000</td> <td>PZ</td> </tr> <tr> <td>TB3225B0</td> <td>TB2820A-TUB O EPDM NERO 670MM</td> <td>1.000</td> <td>PZ</td> </tr> <tr> <td>TB3614A0</td> <td>TB2820A-L=96 MM NERO EPD</td> <td>1.000</td> <td>PZ</td> </tr> <tr> <td>TB5361A0</td> <td>TB3132A-TUB O EPDM TELAIO BIANCO-BLU 670M</td> <td>1.000</td> <td>PZ</td> </tr> <tr> <td>VI1220A1</td> <td>VITE AUTOFIL. 4.2X11 TCS+ MARUTEX</td> <td>2.000</td> <td>PZ</td> </tr> <tr> <td>VL1019A0</td> <td>POMPA DETERGENTE VIBRAZIONE</td> <td>1.000</td> <td>PZ</td> </tr> <tr> <td>VL1047A1</td> <td>PORTAGOMM A D6 CODOLO D8</td> <td>1.000</td> <td>PZ</td> </tr> <tr> <td>VL1054B0</td> <td>DISTRIBUTOR E INGRESSI LAVAGGIO ON</td> <td>1.000</td> <td>PZ</td> </tr> <tr> <td>VL1102A1</td> <td>FILTRO IN LINEA DET. + VNR BARBED 6 MM</td> <td>1.000</td> <td>PZ</td> </tr> <tr> <td>VL1128A1</td> <td>VALVOLA VNR BARBED D6</td> <td>1.000</td> <td>PZ</td> </tr> <tr> <td>VL1166A0</td> <td>RACCORDO A L BAM-BB6</td> <td>1.000</td> <td>PZ</td> </tr> <tr> <td>VL1174C0</td> <td>UGELLO CALIBRATO D1.2 MM</td> <td>1.000</td> <td>PZ</td> </tr> <tr> <td>VL1191A0</td> <td>DISTRIBUTOR E USCITA LAVAGGIO ON</td> <td>1.000</td> <td>PZ</td> </tr> <tr> <td>VL1214A0</td> <td>VALVOLA VNR BB6-BAIONET TA</td> <td>1.000</td> <td>PZ</td> </tr> <tr> <td>VM2172A0</td> <td>CLIP BLOCCAGGIO POMPA CON CIRCUITO</td> <td>2.000</td> <td>PZ</td> </tr> </tbody> </table>	Code	Description	Qty	UOM	RC1019A0	FASCETTA ELASTICA D10 ZINCATA	12.000	PZ	RC1242A0	TERMINALE CHIUSO D10	2.000	PZ	RC1414A1	FASCETTA STRINGITUBO A SCATTO D11,5-12,5	4.000	PZ	TB2821A0	TB2820A-L=40 MM EPDM NER	4.000	PZ	TB3004A0	TB2820A-L=57 0MM EPDM NERO	1.000	PZ	TB3225B0	TB2820A-TUB O EPDM NERO 670MM	1.000	PZ	TB3614A0	TB2820A-L=96 MM NERO EPD	1.000	PZ	TB5361A0	TB3132A-TUB O EPDM TELAIO BIANCO-BLU 670M	1.000	PZ	VI1220A1	VITE AUTOFIL. 4.2X11 TCS+ MARUTEX	2.000	PZ	VL1019A0	POMPA DETERGENTE VIBRAZIONE	1.000	PZ	VL1047A1	PORTAGOMM A D6 CODOLO D8	1.000	PZ	VL1054B0	DISTRIBUTOR E INGRESSI LAVAGGIO ON	1.000	PZ	VL1102A1	FILTRO IN LINEA DET. + VNR BARBED 6 MM	1.000	PZ	VL1128A1	VALVOLA VNR BARBED D6	1.000	PZ	VL1166A0	RACCORDO A L BAM-BB6	1.000	PZ	VL1174C0	UGELLO CALIBRATO D1.2 MM	1.000	PZ	VL1191A0	DISTRIBUTOR E USCITA LAVAGGIO ON	1.000	PZ	VL1214A0	VALVOLA VNR BB6-BAIONET TA	1.000	PZ	VM2172A0	CLIP BLOCCAGGIO POMPA CON CIRCUITO	2.000	PZ
Code	Description	Qty	UOM																																																																																		
RC1019A0	FASCETTA ELASTICA D10 ZINCATA	12.000	PZ																																																																																		
RC1242A0	TERMINALE CHIUSO D10	2.000	PZ																																																																																		
RC1414A1	FASCETTA STRINGITUBO A SCATTO D11,5-12,5	4.000	PZ																																																																																		
TB2821A0	TB2820A-L=40 MM EPDM NER	4.000	PZ																																																																																		
TB3004A0	TB2820A-L=57 0MM EPDM NERO	1.000	PZ																																																																																		
TB3225B0	TB2820A-TUB O EPDM NERO 670MM	1.000	PZ																																																																																		
TB3614A0	TB2820A-L=96 MM NERO EPD	1.000	PZ																																																																																		
TB5361A0	TB3132A-TUB O EPDM TELAIO BIANCO-BLU 670M	1.000	PZ																																																																																		
VI1220A1	VITE AUTOFIL. 4.2X11 TCS+ MARUTEX	2.000	PZ																																																																																		
VL1019A0	POMPA DETERGENTE VIBRAZIONE	1.000	PZ																																																																																		
VL1047A1	PORTAGOMM A D6 CODOLO D8	1.000	PZ																																																																																		
VL1054B0	DISTRIBUTOR E INGRESSI LAVAGGIO ON	1.000	PZ																																																																																		
VL1102A1	FILTRO IN LINEA DET. + VNR BARBED 6 MM	1.000	PZ																																																																																		
VL1128A1	VALVOLA VNR BARBED D6	1.000	PZ																																																																																		
VL1166A0	RACCORDO A L BAM-BB6	1.000	PZ																																																																																		
VL1174C0	UGELLO CALIBRATO D1.2 MM	1.000	PZ																																																																																		
VL1191A0	DISTRIBUTOR E USCITA LAVAGGIO ON	1.000	PZ																																																																																		
VL1214A0	VALVOLA VNR BB6-BAIONET TA	1.000	PZ																																																																																		
VM2172A0	CLIP BLOCCAGGIO POMPA CON CIRCUITO	2.000	PZ																																																																																		

COMPONENT			SPARE PART																						
Code	Description	Image	Code	Description	Kit components																				
EL1440A	ELETTROVALVOLA H2O AUTOPULENTE BAF EU		KEL1440A	SELF CLEANING WATER VALVE KIT	<table border="1"> <thead> <tr> <th>Code</th> <th>Description</th> <th>Qty</th> <th>UOM</th> </tr> </thead> <tbody> <tr> <td>EL1440A0</td> <td>ELETTROVALV OLA H2O AUTOPULENTE E BAF EU</td> <td>1.000</td> <td>PZ</td> </tr> <tr> <td>GN1526A0</td> <td>O-RING D.INT6.9 SP1.8</td> <td>2.000</td> <td>PZ</td> </tr> <tr> <td>RC1131A0</td> <td>FASCETTA 200X2.6 BIANC</td> <td>1.000</td> <td>PZ</td> </tr> <tr> <td>VM2172A0</td> <td>CLIP BLOCCAGGIO POMPA CON CIRCUITO</td> <td>1.000</td> <td>PZ</td> </tr> </tbody> </table>	Code	Description	Qty	UOM	EL1440A0	ELETTROVALV OLA H2O AUTOPULENTE E BAF EU	1.000	PZ	GN1526A0	O-RING D.INT6.9 SP1.8	2.000	PZ	RC1131A0	FASCETTA 200X2.6 BIANC	1.000	PZ	VM2172A0	CLIP BLOCCAGGIO POMPA CON CIRCUITO	1.000	PZ
Code	Description	Qty	UOM																						
EL1440A0	ELETTROVALV OLA H2O AUTOPULENTE E BAF EU	1.000	PZ																						
GN1526A0	O-RING D.INT6.9 SP1.8	2.000	PZ																						
RC1131A0	FASCETTA 200X2.6 BIANC	1.000	PZ																						
VM2172A0	CLIP BLOCCAGGIO POMPA CON CIRCUITO	1.000	PZ																						
GN1526A	O-RING D.INT6.9 SP1.8		KGN1526A	O-RING INT D6.9 THICK1.8 10PCS KIT	<table border="1"> <thead> <tr> <th>Code</th> <th>Description</th> <th>Qty</th> <th>UOM</th> </tr> </thead> <tbody> <tr> <td>GN1526A0</td> <td>O-RING D.INT6.9 SP1.8</td> <td>10.000</td> <td>PZ</td> </tr> </tbody> </table>	Code	Description	Qty	UOM	GN1526A0	O-RING D.INT6.9 SP1.8	10.000	PZ												
Code	Description	Qty	UOM																						
GN1526A0	O-RING D.INT6.9 SP1.8	10.000	PZ																						
RC1019A	FASCETTA ELASTICA D10 ZINCATA		KRC1019A	Ø10 ZINC PLATED ELASTIC CLAMP 15 PCS KIT	<table border="1"> <thead> <tr> <th>Code</th> <th>Description</th> <th>Qty</th> <th>UOM</th> </tr> </thead> <tbody> <tr> <td>RC1019A0</td> <td>FASCETTA ELASTICA D10 ZINCATA</td> <td>15.000</td> <td>PZ</td> </tr> </tbody> </table>	Code	Description	Qty	UOM	RC1019A0	FASCETTA ELASTICA D10 ZINCATA	15.000	PZ												
Code	Description	Qty	UOM																						
RC1019A0	FASCETTA ELASTICA D10 ZINCATA	15.000	PZ																						
RC1414A	FASCETTA STRINGITUBO A SCATTO D11.5-12.5		KRC1414A	D11-12 HOSE SNAP CLAMP 50 PCS KIT	<table border="1"> <thead> <tr> <th>Code</th> <th>Description</th> <th>Qty</th> <th>UOM</th> </tr> </thead> <tbody> <tr> <td>RC1414A1</td> <td>FASCETTA STRINGITUBO A SCATTO D11.5-12.5</td> <td>50.000</td> <td>PZ</td> </tr> </tbody> </table>	Code	Description	Qty	UOM	RC1414A1	FASCETTA STRINGITUBO A SCATTO D11.5-12.5	50.000	PZ												
Code	Description	Qty	UOM																						
RC1414A1	FASCETTA STRINGITUBO A SCATTO D11.5-12.5	50.000	PZ																						
TB3004A	TB2820A-L=570MM EPDM NERO		KTB1343A	TB2820A0 6x10 EPM DETERGENT PIPE 3M KIT	<table border="1"> <thead> <tr> <th>Code</th> <th>Description</th> <th>Qty</th> <th>UOM</th> </tr> </thead> <tbody> <tr> <td>TB2820A0</td> <td>TUBO EPDM 6X10</td> <td>3.000</td> <td>M</td> </tr> </tbody> </table>	Code	Description	Qty	UOM	TB2820A0	TUBO EPDM 6X10	3.000	M												
Code	Description	Qty	UOM																						
TB2820A0	TUBO EPDM 6X10	3.000	M																						

COMPONENT			SPARE PART																										
Code	Description	Image	Code	Description	Kit components																								
TB3225B	TB2820A-TUBO EPDM NERO 670MM		KTB1343A	TB2820A0 6x10 EPM DETERGENT PIPE 3M KIT	<table border="1"> <thead> <tr> <th>Code</th> <th>Description</th> <th>Qty</th> <th>UOM</th> </tr> </thead> <tbody> <tr> <td>TB2820A0</td> <td>TUBO EPDM 6X10</td> <td>3.000</td> <td>M</td> </tr> </tbody> </table>	Code	Description	Qty	UOM	TB2820A0	TUBO EPDM 6X10	3.000	M																
Code	Description	Qty	UOM																										
TB2820A0	TUBO EPDM 6X10	3.000	M																										
VL1102A	FILTRO IN LINEA DET. + VNR BARBED 6 MM		XRF074	UC 5511 DOUBLE DET FILTER RETROFIT KIT	<table border="1"> <thead> <tr> <th>Code</th> <th>Description</th> <th>Qty</th> <th>UOM</th> </tr> </thead> <tbody> <tr> <td>EL1185A0</td> <td>RACCORDO A GOMITO J.GUEST Ø8F - Ø8F</td> <td>1.000</td> <td>PZ</td> </tr> <tr> <td>RC1019A0</td> <td>FASCETTA ELASTICA D10 ZINCATA</td> <td>4.000</td> <td>PZ</td> </tr> <tr> <td>VL1047A1</td> <td>PORTAGOMM A D6 CODOLO D8</td> <td>2.000</td> <td>PZ</td> </tr> <tr> <td>VL1102A1</td> <td>FILTRO IN LINEA DET. + VNR BARBED 6 MM</td> <td>2.000</td> <td>PZ</td> </tr> </tbody> </table>	Code	Description	Qty	UOM	EL1185A0	RACCORDO A GOMITO J.GUEST Ø8F - Ø8F	1.000	PZ	RC1019A0	FASCETTA ELASTICA D10 ZINCATA	4.000	PZ	VL1047A1	PORTAGOMM A D6 CODOLO D8	2.000	PZ	VL1102A1	FILTRO IN LINEA DET. + VNR BARBED 6 MM	2.000	PZ				
Code	Description	Qty	UOM																										
EL1185A0	RACCORDO A GOMITO J.GUEST Ø8F - Ø8F	1.000	PZ																										
RC1019A0	FASCETTA ELASTICA D10 ZINCATA	4.000	PZ																										
VL1047A1	PORTAGOMM A D6 CODOLO D8	2.000	PZ																										
VL1102A1	FILTRO IN LINEA DET. + VNR BARBED 6 MM	2.000	PZ																										
			XRF073	VL1102A DOUBLE DET FILTER RETROFIT KIT	<table border="1"> <thead> <tr> <th>Code</th> <th>Description</th> <th>Qty</th> <th>UOM</th> </tr> </thead> <tbody> <tr> <td>RC1019A0</td> <td>FASCETTA ELASTICA D10 ZINCATA</td> <td>4.000</td> <td>PZ</td> </tr> <tr> <td>VL1102A1</td> <td>FILTRO IN LINEA DET. + VNR BARBED 6 MM</td> <td>2.000</td> <td>PZ</td> </tr> </tbody> </table>	Code	Description	Qty	UOM	RC1019A0	FASCETTA ELASTICA D10 ZINCATA	4.000	PZ	VL1102A1	FILTRO IN LINEA DET. + VNR BARBED 6 MM	2.000	PZ												
Code	Description	Qty	UOM																										
RC1019A0	FASCETTA ELASTICA D10 ZINCATA	4.000	PZ																										
VL1102A1	FILTRO IN LINEA DET. + VNR BARBED 6 MM	2.000	PZ																										
VL1166A	RACCORDO A L BAM-BB6		KVL2618A	2 ROTOR ARMS ONE CLEANING SYSTEM KIT	<table border="1"> <thead> <tr> <th>Code</th> <th>Description</th> <th>Qty</th> <th>UOM</th> </tr> </thead> <tbody> <tr> <td>0H2202A1</td> <td>STAFFA LAVAGGIO ONE CON ELV STEAM</td> <td>2.000</td> <td>PZ</td> </tr> <tr> <td>CE1030A0</td> <td>FASTON FEMMINA 6.3X0.8 0.5-1mmq</td> <td>4.000</td> <td>PZ</td> </tr> <tr> <td>CE1395A0</td> <td>FASTON MASCHIO 6,3 X 0,8 RAME STAGNATO</td> <td>2.000</td> <td>PZ</td> </tr> <tr> <td>CE1545A0</td> <td>CAVO UNIP AWG18 ST.3135 BLU</td> <td>2.000</td> <td>M</td> </tr> <tr> <td>CE1570A0</td> <td>CAVO UNIP AWG18 ST.3135 BIANC</td> <td>2.000</td> <td>M</td> </tr> </tbody> </table>	Code	Description	Qty	UOM	0H2202A1	STAFFA LAVAGGIO ONE CON ELV STEAM	2.000	PZ	CE1030A0	FASTON FEMMINA 6.3X0.8 0.5-1mmq	4.000	PZ	CE1395A0	FASTON MASCHIO 6,3 X 0,8 RAME STAGNATO	2.000	PZ	CE1545A0	CAVO UNIP AWG18 ST.3135 BLU	2.000	M	CE1570A0	CAVO UNIP AWG18 ST.3135 BIANC	2.000	M
Code	Description	Qty	UOM																										
0H2202A1	STAFFA LAVAGGIO ONE CON ELV STEAM	2.000	PZ																										
CE1030A0	FASTON FEMMINA 6.3X0.8 0.5-1mmq	4.000	PZ																										
CE1395A0	FASTON MASCHIO 6,3 X 0,8 RAME STAGNATO	2.000	PZ																										
CE1545A0	CAVO UNIP AWG18 ST.3135 BLU	2.000	M																										
CE1570A0	CAVO UNIP AWG18 ST.3135 BIANC	2.000	M																										

COMPONENT			SPARE PART																																																																														
Code	Description	Image	Code	Description	Kit components																																																																												
VL1166A	RACCORDO A L BAM-BB6		KVL2618A	2 ROTOR ARMS ONE CLEANING SYSTEM KIT	<table border="1"> <thead> <tr> <th>Code</th> <th>Description</th> <th>Qty</th> <th>UOM</th> </tr> </thead> <tbody> <tr> <td>CE1660A0</td> <td>COPRI FASTON FEMMINA 6.3X0.8</td> <td>4.000</td> <td>PZ</td> </tr> <tr> <td>CE1661A0</td> <td>COPRI FASTON MASCCHIO 6.3X0.8</td> <td>2.000</td> <td>PZ</td> </tr> <tr> <td>EL1020A1</td> <td>RACCORDO INTERMEDIO "T" TUBO D8 J</td> <td>1.000</td> <td>PZ</td> </tr> <tr> <td>EL1346A0</td> <td>CLIP BLOCCA PINZETTA RACCORDI D10 TIERRE</td> <td>4.000</td> <td>PZ</td> </tr> <tr> <td>EL1440A0</td> <td>ELETTROVALV OLA H2O AUTOPULENT E BAF EU</td> <td>2.000</td> <td>PZ</td> </tr> <tr> <td>GN1526A0</td> <td>O-RING D.INT6.9 SP1.8</td> <td>6.000</td> <td>PZ</td> </tr> <tr> <td>RC1018A0</td> <td>FASCETTA ELASTICA D12 ZINCATA</td> <td>2.000</td> <td>PZ</td> </tr> <tr> <td>RC1019A0</td> <td>FASCETTA ELASTICA D10 ZINCATA</td> <td>3.000</td> <td>PZ</td> </tr> <tr> <td>RC1130A0</td> <td>FASCETTA 130X2,6</td> <td>4.000</td> <td>PZ</td> </tr> <tr> <td>RC1242A0</td> <td>TERMINALE CHIUSO D10</td> <td>4.000</td> <td>PZ</td> </tr> <tr> <td>RC1414A1</td> <td>FASCETTA STRINGITUBO A SCATTO D11.5-12.5</td> <td>5.000</td> <td>PZ</td> </tr> <tr> <td>TB2821A0</td> <td>TB2820A-L=40 MM EPDM NER</td> <td>12.000</td> <td>PZ</td> </tr> <tr> <td>TB3004A0</td> <td>TB2820A-L=57 0MM EPDM NERO</td> <td>2.000</td> <td>PZ</td> </tr> <tr> <td>TB3009B0</td> <td>TB3132A-L=67 0MM EPDM BIANCO BLU</td> <td>2.000</td> <td>PZ</td> </tr> <tr> <td>TB3225B0</td> <td>TB2820A-TUB O EPDM NERO 670MM</td> <td>2.000</td> <td>PZ</td> </tr> <tr> <td>VI1220A1</td> <td>VITE AUTOFIL. 4.2X11 TCS+ MARUTEX</td> <td>2.000</td> <td>PZ</td> </tr> <tr> <td>VL1019A0</td> <td>POMPA DETERGENTE VIBRAZIONE</td> <td>2.000</td> <td>PZ</td> </tr> <tr> <td>VL1047A1</td> <td>PORTAGOMM A D6 CODOLO D8</td> <td>2.000</td> <td>PZ</td> </tr> </tbody> </table>	Code	Description	Qty	UOM	CE1660A0	COPRI FASTON FEMMINA 6.3X0.8	4.000	PZ	CE1661A0	COPRI FASTON MASCCHIO 6.3X0.8	2.000	PZ	EL1020A1	RACCORDO INTERMEDIO "T" TUBO D8 J	1.000	PZ	EL1346A0	CLIP BLOCCA PINZETTA RACCORDI D10 TIERRE	4.000	PZ	EL1440A0	ELETTROVALV OLA H2O AUTOPULENT E BAF EU	2.000	PZ	GN1526A0	O-RING D.INT6.9 SP1.8	6.000	PZ	RC1018A0	FASCETTA ELASTICA D12 ZINCATA	2.000	PZ	RC1019A0	FASCETTA ELASTICA D10 ZINCATA	3.000	PZ	RC1130A0	FASCETTA 130X2,6	4.000	PZ	RC1242A0	TERMINALE CHIUSO D10	4.000	PZ	RC1414A1	FASCETTA STRINGITUBO A SCATTO D11.5-12.5	5.000	PZ	TB2821A0	TB2820A-L=40 MM EPDM NER	12.000	PZ	TB3004A0	TB2820A-L=57 0MM EPDM NERO	2.000	PZ	TB3009B0	TB3132A-L=67 0MM EPDM BIANCO BLU	2.000	PZ	TB3225B0	TB2820A-TUB O EPDM NERO 670MM	2.000	PZ	VI1220A1	VITE AUTOFIL. 4.2X11 TCS+ MARUTEX	2.000	PZ	VL1019A0	POMPA DETERGENTE VIBRAZIONE	2.000	PZ	VL1047A1	PORTAGOMM A D6 CODOLO D8	2.000	PZ
Code	Description	Qty	UOM																																																																														
CE1660A0	COPRI FASTON FEMMINA 6.3X0.8	4.000	PZ																																																																														
CE1661A0	COPRI FASTON MASCCHIO 6.3X0.8	2.000	PZ																																																																														
EL1020A1	RACCORDO INTERMEDIO "T" TUBO D8 J	1.000	PZ																																																																														
EL1346A0	CLIP BLOCCA PINZETTA RACCORDI D10 TIERRE	4.000	PZ																																																																														
EL1440A0	ELETTROVALV OLA H2O AUTOPULENT E BAF EU	2.000	PZ																																																																														
GN1526A0	O-RING D.INT6.9 SP1.8	6.000	PZ																																																																														
RC1018A0	FASCETTA ELASTICA D12 ZINCATA	2.000	PZ																																																																														
RC1019A0	FASCETTA ELASTICA D10 ZINCATA	3.000	PZ																																																																														
RC1130A0	FASCETTA 130X2,6	4.000	PZ																																																																														
RC1242A0	TERMINALE CHIUSO D10	4.000	PZ																																																																														
RC1414A1	FASCETTA STRINGITUBO A SCATTO D11.5-12.5	5.000	PZ																																																																														
TB2821A0	TB2820A-L=40 MM EPDM NER	12.000	PZ																																																																														
TB3004A0	TB2820A-L=57 0MM EPDM NERO	2.000	PZ																																																																														
TB3009B0	TB3132A-L=67 0MM EPDM BIANCO BLU	2.000	PZ																																																																														
TB3225B0	TB2820A-TUB O EPDM NERO 670MM	2.000	PZ																																																																														
VI1220A1	VITE AUTOFIL. 4.2X11 TCS+ MARUTEX	2.000	PZ																																																																														
VL1019A0	POMPA DETERGENTE VIBRAZIONE	2.000	PZ																																																																														
VL1047A1	PORTAGOMM A D6 CODOLO D8	2.000	PZ																																																																														

COMPONENT			SPARE PART																																										
Code	Description	Image	Code	Description	Kit components																																								
VL1166A	RACCORDO A L BAM-BB6		KVL2618A	2 ROTOR ARMS ONE CLEANING SYSTEM KIT	<table border="1"> <thead> <tr> <th>Code</th> <th>Description</th> <th>Qty</th> <th>UOM</th> </tr> </thead> <tbody> <tr> <td>VL1054B0</td> <td>DISTRIBUTOR E INGRESSI LAVAGGIO ON</td> <td>2.000</td> <td>PZ</td> </tr> <tr> <td>VL1102A1</td> <td>FILTRO IN LINEA DET. + VNR BARBED 6 MM</td> <td>2.000</td> <td>PZ</td> </tr> <tr> <td>VL1127A1</td> <td>RACCORDO A T BARBED 6</td> <td>1.000</td> <td>PZ</td> </tr> <tr> <td>VL1128A1</td> <td>VALVOLA VNR BARBED D6</td> <td>4.000</td> <td>PZ</td> </tr> <tr> <td>VL1166A0</td> <td>RACCORDO A L BAM-BB6</td> <td>2.000</td> <td>PZ</td> </tr> <tr> <td>VL1174C0</td> <td>UGELLO CALIBRATO D1.2 MM</td> <td>2.000</td> <td>PZ</td> </tr> <tr> <td>VL1191A0</td> <td>DISTRIBUTOR E USCITA LAVAGGIO ON</td> <td>2.000</td> <td>PZ</td> </tr> <tr> <td>VL1214A0</td> <td>VALVOLA VNR BB6-BAIONET TA</td> <td>2.000</td> <td>PZ</td> </tr> <tr> <td>VM2172A0</td> <td>CLIP BLOCCAGGIO POMPA CON CIRCUITO</td> <td>4.000</td> <td>PZ</td> </tr> </tbody> </table>	Code	Description	Qty	UOM	VL1054B0	DISTRIBUTOR E INGRESSI LAVAGGIO ON	2.000	PZ	VL1102A1	FILTRO IN LINEA DET. + VNR BARBED 6 MM	2.000	PZ	VL1127A1	RACCORDO A T BARBED 6	1.000	PZ	VL1128A1	VALVOLA VNR BARBED D6	4.000	PZ	VL1166A0	RACCORDO A L BAM-BB6	2.000	PZ	VL1174C0	UGELLO CALIBRATO D1.2 MM	2.000	PZ	VL1191A0	DISTRIBUTOR E USCITA LAVAGGIO ON	2.000	PZ	VL1214A0	VALVOLA VNR BB6-BAIONET TA	2.000	PZ	VM2172A0	CLIP BLOCCAGGIO POMPA CON CIRCUITO	4.000	PZ
			Code		Description	Qty	UOM																																						
VL1054B0	DISTRIBUTOR E INGRESSI LAVAGGIO ON	2.000	PZ																																										
VL1102A1	FILTRO IN LINEA DET. + VNR BARBED 6 MM	2.000	PZ																																										
VL1127A1	RACCORDO A T BARBED 6	1.000	PZ																																										
VL1128A1	VALVOLA VNR BARBED D6	4.000	PZ																																										
VL1166A0	RACCORDO A L BAM-BB6	2.000	PZ																																										
VL1174C0	UGELLO CALIBRATO D1.2 MM	2.000	PZ																																										
VL1191A0	DISTRIBUTOR E USCITA LAVAGGIO ON	2.000	PZ																																										
VL1214A0	VALVOLA VNR BB6-BAIONET TA	2.000	PZ																																										
VM2172A0	CLIP BLOCCAGGIO POMPA CON CIRCUITO	4.000	PZ																																										
KVL1225A	US HOOD WASHING SYSTEM KIT	<table border="1"> <thead> <tr> <th>Code</th> <th>Description</th> <th>Qty</th> <th>UOM</th> </tr> </thead> <tbody> <tr> <td>0H2213A1</td> <td>LAMIERA IMPIANTO IDRICO CAPPA</td> <td>1.000</td> <td>PZ</td> </tr> <tr> <td>EL1346A0</td> <td>CLIP BLOCCA PINZETTA RACCORDI D10 TIERRE</td> <td>2.000</td> <td>PZ</td> </tr> <tr> <td>EL1450A0</td> <td>ELETTROVALV OLA H2O AUTOPULENT E BAF USA</td> <td>2.000</td> <td>PZ</td> </tr> <tr> <td>GN1526A0</td> <td>O-RING D.INT6.9 SP1.8</td> <td>5.000</td> <td>PZ</td> </tr> <tr> <td>RC1019A0</td> <td>FASCETTA ELASTICA D10 ZINCATA</td> <td>14.000</td> <td>PZ</td> </tr> <tr> <td>RC1131A0</td> <td>FASCETTA 200X2.6 BIANC</td> <td>1.000</td> <td>PZ</td> </tr> <tr> <td>RC1242A0</td> <td>TERMINALE CHIUSO D10</td> <td>2.000</td> <td>PZ</td> </tr> <tr> <td>RC1414A1</td> <td>FASCETTA STRINGITUBO A SCATTO D11.5-12.5</td> <td>4.000</td> <td>PZ</td> </tr> <tr> <td>TB2821A0</td> <td>TB2820A-L=40 MM EPDM NER</td> <td>4.000</td> <td>PZ</td> </tr> </tbody> </table>	Code	Description	Qty	UOM	0H2213A1	LAMIERA IMPIANTO IDRICO CAPPA	1.000	PZ	EL1346A0	CLIP BLOCCA PINZETTA RACCORDI D10 TIERRE	2.000	PZ	EL1450A0	ELETTROVALV OLA H2O AUTOPULENT E BAF USA	2.000	PZ	GN1526A0	O-RING D.INT6.9 SP1.8	5.000	PZ	RC1019A0	FASCETTA ELASTICA D10 ZINCATA	14.000	PZ	RC1131A0	FASCETTA 200X2.6 BIANC	1.000	PZ	RC1242A0	TERMINALE CHIUSO D10	2.000	PZ	RC1414A1	FASCETTA STRINGITUBO A SCATTO D11.5-12.5	4.000	PZ	TB2821A0	TB2820A-L=40 MM EPDM NER	4.000	PZ			
Code		Description	Qty	UOM																																									
0H2213A1		LAMIERA IMPIANTO IDRICO CAPPA	1.000	PZ																																									
EL1346A0		CLIP BLOCCA PINZETTA RACCORDI D10 TIERRE	2.000	PZ																																									
EL1450A0		ELETTROVALV OLA H2O AUTOPULENT E BAF USA	2.000	PZ																																									
GN1526A0		O-RING D.INT6.9 SP1.8	5.000	PZ																																									
RC1019A0		FASCETTA ELASTICA D10 ZINCATA	14.000	PZ																																									
RC1131A0		FASCETTA 200X2.6 BIANC	1.000	PZ																																									
RC1242A0		TERMINALE CHIUSO D10	2.000	PZ																																									
RC1414A1		FASCETTA STRINGITUBO A SCATTO D11.5-12.5	4.000	PZ																																									
TB2821A0	TB2820A-L=40 MM EPDM NER	4.000	PZ																																										

COMPONENT			SPARE PART																																																																														
Code	Description	Image	Code	Description	Kit components																																																																												
VL1166A	RACCORDO A L BAM-BB6		KVL1225A	US HOOD WASHING SYSTEM KIT	<table border="1"> <thead> <tr> <th>Code</th> <th>Description</th> <th>Qty</th> <th>UOM</th> </tr> </thead> <tbody> <tr> <td>TB2994A0</td> <td>TB2820A-TUB O EPDM NERO 1000MM</td> <td>2.000</td> <td>PZ</td> </tr> <tr> <td>TB3252A0</td> <td>TB3132A-L=23 0MM EPDM BIANCO BLU</td> <td>2.000</td> <td>PZ</td> </tr> <tr> <td>TB3614A0</td> <td>TB2820A-L=96 MM NERO EPD</td> <td>1.000</td> <td>PZ</td> </tr> <tr> <td>VI1220A1</td> <td>VITE AUTOFIL. 4.2X11 TCS+ MARUTEX</td> <td>3.000</td> <td>PZ</td> </tr> <tr> <td>VI2070A0</td> <td>VITE AUTOFIL 40X8 TCB+ SHEETTRACS</td> <td>2.000</td> <td>PZ</td> </tr> <tr> <td>VL1019A0</td> <td>POMPA DETERGENTE VIBRAZIONE</td> <td>1.000</td> <td>PZ</td> </tr> <tr> <td>VL1047A1</td> <td>PORTAGOMM A D6 CODOLO D8</td> <td>1.000</td> <td>PZ</td> </tr> <tr> <td>VL1054B0</td> <td>DISTRIBUTOR E INGRESSI LAVAGGIO ON</td> <td>1.000</td> <td>PZ</td> </tr> <tr> <td>VL1102A1</td> <td>FILTRO IN LINEA DET. + VNR BARBED 6 MM</td> <td>1.000</td> <td>PZ</td> </tr> <tr> <td>VL1127A1</td> <td>RACCORDO A T BARBED 6</td> <td>1.000</td> <td>PZ</td> </tr> <tr> <td>VL1128A1</td> <td>VALVOLA VNR BARBED D6</td> <td>1.000</td> <td>PZ</td> </tr> <tr> <td>VL1165A0</td> <td>RACCORDO DRITTO BAM-BB6</td> <td>1.000</td> <td>PZ</td> </tr> <tr> <td>VL1166A0</td> <td>RACCORDO A L BAM-BB6</td> <td>2.000</td> <td>PZ</td> </tr> <tr> <td>VL1174C0</td> <td>UGELLO CALIBRATO D1.2 MM</td> <td>1.000</td> <td>PZ</td> </tr> <tr> <td>VL1191A0</td> <td>DISTRIBUTOR E USCITA LAVAGGIO ON</td> <td>1.000</td> <td>PZ</td> </tr> <tr> <td>VL1214A0</td> <td>VALVOLA VNR BB6-BAIONET TA</td> <td>1.000</td> <td>PZ</td> </tr> <tr> <td>VM1605A0</td> <td>CLIP TWIST LOCK DIAM. 10,2-12,7 MM</td> <td>2.000</td> <td>PZ</td> </tr> <tr> <td>VM2172A0</td> <td>CLIP BLOCCAGGIO POMPA CON CIRCUITO</td> <td>3.000</td> <td>PZ</td> </tr> </tbody> </table>	Code	Description	Qty	UOM	TB2994A0	TB2820A-TUB O EPDM NERO 1000MM	2.000	PZ	TB3252A0	TB3132A-L=23 0MM EPDM BIANCO BLU	2.000	PZ	TB3614A0	TB2820A-L=96 MM NERO EPD	1.000	PZ	VI1220A1	VITE AUTOFIL. 4.2X11 TCS+ MARUTEX	3.000	PZ	VI2070A0	VITE AUTOFIL 40X8 TCB+ SHEETTRACS	2.000	PZ	VL1019A0	POMPA DETERGENTE VIBRAZIONE	1.000	PZ	VL1047A1	PORTAGOMM A D6 CODOLO D8	1.000	PZ	VL1054B0	DISTRIBUTOR E INGRESSI LAVAGGIO ON	1.000	PZ	VL1102A1	FILTRO IN LINEA DET. + VNR BARBED 6 MM	1.000	PZ	VL1127A1	RACCORDO A T BARBED 6	1.000	PZ	VL1128A1	VALVOLA VNR BARBED D6	1.000	PZ	VL1165A0	RACCORDO DRITTO BAM-BB6	1.000	PZ	VL1166A0	RACCORDO A L BAM-BB6	2.000	PZ	VL1174C0	UGELLO CALIBRATO D1.2 MM	1.000	PZ	VL1191A0	DISTRIBUTOR E USCITA LAVAGGIO ON	1.000	PZ	VL1214A0	VALVOLA VNR BB6-BAIONET TA	1.000	PZ	VM1605A0	CLIP TWIST LOCK DIAM. 10,2-12,7 MM	2.000	PZ	VM2172A0	CLIP BLOCCAGGIO POMPA CON CIRCUITO	3.000	PZ
Code	Description	Qty	UOM																																																																														
TB2994A0	TB2820A-TUB O EPDM NERO 1000MM	2.000	PZ																																																																														
TB3252A0	TB3132A-L=23 0MM EPDM BIANCO BLU	2.000	PZ																																																																														
TB3614A0	TB2820A-L=96 MM NERO EPD	1.000	PZ																																																																														
VI1220A1	VITE AUTOFIL. 4.2X11 TCS+ MARUTEX	3.000	PZ																																																																														
VI2070A0	VITE AUTOFIL 40X8 TCB+ SHEETTRACS	2.000	PZ																																																																														
VL1019A0	POMPA DETERGENTE VIBRAZIONE	1.000	PZ																																																																														
VL1047A1	PORTAGOMM A D6 CODOLO D8	1.000	PZ																																																																														
VL1054B0	DISTRIBUTOR E INGRESSI LAVAGGIO ON	1.000	PZ																																																																														
VL1102A1	FILTRO IN LINEA DET. + VNR BARBED 6 MM	1.000	PZ																																																																														
VL1127A1	RACCORDO A T BARBED 6	1.000	PZ																																																																														
VL1128A1	VALVOLA VNR BARBED D6	1.000	PZ																																																																														
VL1165A0	RACCORDO DRITTO BAM-BB6	1.000	PZ																																																																														
VL1166A0	RACCORDO A L BAM-BB6	2.000	PZ																																																																														
VL1174C0	UGELLO CALIBRATO D1.2 MM	1.000	PZ																																																																														
VL1191A0	DISTRIBUTOR E USCITA LAVAGGIO ON	1.000	PZ																																																																														
VL1214A0	VALVOLA VNR BB6-BAIONET TA	1.000	PZ																																																																														
VM1605A0	CLIP TWIST LOCK DIAM. 10,2-12,7 MM	2.000	PZ																																																																														
VM2172A0	CLIP BLOCCAGGIO POMPA CON CIRCUITO	3.000	PZ																																																																														

COMPONENT			SPARE PART																																																																														
Code	Description	Image	Code	Description	Kit components																																																																												
VL1166A	RACCORDO A L BAM-BB6		KVL1222A	EUR 0311 ONE PLUS CLEANING SYSTEM KIT	<table border="1"> <thead> <tr> <th>Code</th> <th>Description</th> <th>Qty</th> <th>UOM</th> </tr> </thead> <tbody> <tr> <td>0H2486A0</td> <td>LAMIERA IMPIANTO LAVAGGIO 031</td> <td>1.000</td> <td>PZ</td> </tr> <tr> <td>EL1346A0</td> <td>CLIP BLOCCA PINZETTA RACCORDI D10 TIERRE</td> <td>2.000</td> <td>PZ</td> </tr> <tr> <td>EL1440A0</td> <td>ELETTROVALV OLA H2O AUTOPULENT E BAF EU</td> <td>1.000</td> <td>PZ</td> </tr> <tr> <td>GN1526A0</td> <td>O-RING D.INT6.9 SP1.8</td> <td>3.000</td> <td>PZ</td> </tr> <tr> <td>RC1019A0</td> <td>FASCETTA ELASTICA D10 ZINCATA</td> <td>12.000</td> <td>PZ</td> </tr> <tr> <td>RC1242A0</td> <td>TERMINALE CHIUSO D10</td> <td>2.000</td> <td>PZ</td> </tr> <tr> <td>RC1414A1</td> <td>FASCETTA STRINGITUBO A SCATTO D11.5-12.5</td> <td>1.000</td> <td>PZ</td> </tr> <tr> <td>TB2821A0</td> <td>TB2820A-L=40 MM EPDM NER</td> <td>4.000</td> <td>PZ</td> </tr> <tr> <td>TB3004A0</td> <td>TB2820A-L=57 0MM EPDM NERO</td> <td>1.000</td> <td>PZ</td> </tr> <tr> <td>TB3009B0</td> <td>TB3132A-L=67 0MM EPDM BIANCO BLU</td> <td>1.000</td> <td>PZ</td> </tr> <tr> <td>TB3225B0</td> <td>TB2820A-TUB O EPDM NERO 670MM</td> <td>1.000</td> <td>PZ</td> </tr> <tr> <td>TB3614A0</td> <td>TB2820A-L=96 MM NERO EPD</td> <td>1.000</td> <td>PZ</td> </tr> <tr> <td>VI1220A1</td> <td>VITE AUTOFIL. 4.2X11 TCS+ MARUTEX</td> <td>4.000</td> <td>PZ</td> </tr> <tr> <td>VI2070A0</td> <td>VITE AUTOFIL. 40X8 TCB+ SHEETTRACS</td> <td>2.000</td> <td>PZ</td> </tr> <tr> <td>VL1019A0</td> <td>POMPA DETERGENTE VIBRAZIONE</td> <td>1.000</td> <td>PZ</td> </tr> <tr> <td>VL1047A1</td> <td>PORTAGOMM A D6 CODOLO D8</td> <td>1.000</td> <td>PZ</td> </tr> <tr> <td>VL1054B0</td> <td>DISTRIBUTOR E INGRESSI LAVAGGIO ON</td> <td>1.000</td> <td>PZ</td> </tr> <tr> <td>VL1102A1</td> <td>FILTRO IN LINEA DET. + VNR BARBED 6 MM</td> <td>1.000</td> <td>PZ</td> </tr> </tbody> </table>	Code	Description	Qty	UOM	0H2486A0	LAMIERA IMPIANTO LAVAGGIO 031	1.000	PZ	EL1346A0	CLIP BLOCCA PINZETTA RACCORDI D10 TIERRE	2.000	PZ	EL1440A0	ELETTROVALV OLA H2O AUTOPULENT E BAF EU	1.000	PZ	GN1526A0	O-RING D.INT6.9 SP1.8	3.000	PZ	RC1019A0	FASCETTA ELASTICA D10 ZINCATA	12.000	PZ	RC1242A0	TERMINALE CHIUSO D10	2.000	PZ	RC1414A1	FASCETTA STRINGITUBO A SCATTO D11.5-12.5	1.000	PZ	TB2821A0	TB2820A-L=40 MM EPDM NER	4.000	PZ	TB3004A0	TB2820A-L=57 0MM EPDM NERO	1.000	PZ	TB3009B0	TB3132A-L=67 0MM EPDM BIANCO BLU	1.000	PZ	TB3225B0	TB2820A-TUB O EPDM NERO 670MM	1.000	PZ	TB3614A0	TB2820A-L=96 MM NERO EPD	1.000	PZ	VI1220A1	VITE AUTOFIL. 4.2X11 TCS+ MARUTEX	4.000	PZ	VI2070A0	VITE AUTOFIL. 40X8 TCB+ SHEETTRACS	2.000	PZ	VL1019A0	POMPA DETERGENTE VIBRAZIONE	1.000	PZ	VL1047A1	PORTAGOMM A D6 CODOLO D8	1.000	PZ	VL1054B0	DISTRIBUTOR E INGRESSI LAVAGGIO ON	1.000	PZ	VL1102A1	FILTRO IN LINEA DET. + VNR BARBED 6 MM	1.000	PZ
Code	Description	Qty	UOM																																																																														
0H2486A0	LAMIERA IMPIANTO LAVAGGIO 031	1.000	PZ																																																																														
EL1346A0	CLIP BLOCCA PINZETTA RACCORDI D10 TIERRE	2.000	PZ																																																																														
EL1440A0	ELETTROVALV OLA H2O AUTOPULENT E BAF EU	1.000	PZ																																																																														
GN1526A0	O-RING D.INT6.9 SP1.8	3.000	PZ																																																																														
RC1019A0	FASCETTA ELASTICA D10 ZINCATA	12.000	PZ																																																																														
RC1242A0	TERMINALE CHIUSO D10	2.000	PZ																																																																														
RC1414A1	FASCETTA STRINGITUBO A SCATTO D11.5-12.5	1.000	PZ																																																																														
TB2821A0	TB2820A-L=40 MM EPDM NER	4.000	PZ																																																																														
TB3004A0	TB2820A-L=57 0MM EPDM NERO	1.000	PZ																																																																														
TB3009B0	TB3132A-L=67 0MM EPDM BIANCO BLU	1.000	PZ																																																																														
TB3225B0	TB2820A-TUB O EPDM NERO 670MM	1.000	PZ																																																																														
TB3614A0	TB2820A-L=96 MM NERO EPD	1.000	PZ																																																																														
VI1220A1	VITE AUTOFIL. 4.2X11 TCS+ MARUTEX	4.000	PZ																																																																														
VI2070A0	VITE AUTOFIL. 40X8 TCB+ SHEETTRACS	2.000	PZ																																																																														
VL1019A0	POMPA DETERGENTE VIBRAZIONE	1.000	PZ																																																																														
VL1047A1	PORTAGOMM A D6 CODOLO D8	1.000	PZ																																																																														
VL1054B0	DISTRIBUTOR E INGRESSI LAVAGGIO ON	1.000	PZ																																																																														
VL1102A1	FILTRO IN LINEA DET. + VNR BARBED 6 MM	1.000	PZ																																																																														

COMPONENT			SPARE PART																																															
Code	Description	Image	Code	Description	Kit components																																													
VL1166A	RACCORDO A L BAM-BB6		KVL1222A	EUR 0311 ONE PLUS CLEANING SYSTEM KIT	<table border="1"> <thead> <tr> <th>Code</th> <th>Description</th> <th>Qty</th> <th>UOM</th> </tr> </thead> <tbody> <tr> <td>VL1128A1</td> <td>VALVOLA VNR BARBED D6</td> <td>1.000</td> <td>PZ</td> </tr> <tr> <td>VL1166A0</td> <td>RACCORDO A L BAM-BB6</td> <td>1.000</td> <td>PZ</td> </tr> <tr> <td>VL1174C0</td> <td>UGELLO CALIBRATO D1.2 MM</td> <td>1.000</td> <td>PZ</td> </tr> <tr> <td>VL1191A0</td> <td>DISTRIBUTOR E USCITA LAVAGGIO ON</td> <td>1.000</td> <td>PZ</td> </tr> <tr> <td>VL1214A0</td> <td>VALVOLA VNR BB6-BAIONET TA</td> <td>1.000</td> <td>PZ</td> </tr> <tr> <td>VM2172A0</td> <td>CLIP BLOCCAGGIO POMPA CON CIRCUITO</td> <td>2.000</td> <td>PZ</td> </tr> </tbody> </table>	Code	Description	Qty	UOM	VL1128A1	VALVOLA VNR BARBED D6	1.000	PZ	VL1166A0	RACCORDO A L BAM-BB6	1.000	PZ	VL1174C0	UGELLO CALIBRATO D1.2 MM	1.000	PZ	VL1191A0	DISTRIBUTOR E USCITA LAVAGGIO ON	1.000	PZ	VL1214A0	VALVOLA VNR BB6-BAIONET TA	1.000	PZ	VM2172A0	CLIP BLOCCAGGIO POMPA CON CIRCUITO	2.000	PZ																	
			Code	Description	Qty	UOM																																												
VL1128A1	VALVOLA VNR BARBED D6	1.000	PZ																																															
VL1166A0	RACCORDO A L BAM-BB6	1.000	PZ																																															
VL1174C0	UGELLO CALIBRATO D1.2 MM	1.000	PZ																																															
VL1191A0	DISTRIBUTOR E USCITA LAVAGGIO ON	1.000	PZ																																															
VL1214A0	VALVOLA VNR BB6-BAIONET TA	1.000	PZ																																															
VM2172A0	CLIP BLOCCAGGIO POMPA CON CIRCUITO	2.000	PZ																																															
KVL1213A	US PLUS COMPACT WASHING SYSTEM KIT	<table border="1"> <thead> <tr> <th>Code</th> <th>Description</th> <th>Qty</th> <th>UOM</th> </tr> </thead> <tbody> <tr> <td>0H2428A2</td> <td>LAMIERA IMPIANTO LAVAGGIO XECC PLUS</td> <td>1.000</td> <td>PZ</td> </tr> <tr> <td>EL1346A0</td> <td>CLIP BLOCCA PINZETTA RACCORDI D10 TIERRE</td> <td>2.000</td> <td>PZ</td> </tr> <tr> <td>EL1450A0</td> <td>ELETTROVALV OLA H2O AUTOPULENT E BAF USA</td> <td>3.000</td> <td>PZ</td> </tr> <tr> <td>GN1311A0</td> <td>PASSACAVO GOMMA DE=25 DI=12 SP=6.5</td> <td>1.000</td> <td>PZ</td> </tr> <tr> <td>GN1526A0</td> <td>O-RING D.INT6.9 SP1.8</td> <td>7.000</td> <td>PZ</td> </tr> <tr> <td>RC1018A0</td> <td>FASCETTA ELASTICA D12 ZINCATA</td> <td>5.000</td> <td>PZ</td> </tr> <tr> <td>RC1019A0</td> <td>FASCETTA ELASTICA D10 ZINCATA</td> <td>14.000</td> <td>PZ</td> </tr> <tr> <td>RC1130A0</td> <td>FASCETTA 130X2.6</td> <td>1.000</td> <td>PZ</td> </tr> <tr> <td>RC1131A0</td> <td>FASCETTA 200X2.6 BIANC</td> <td>1.000</td> <td>PZ</td> </tr> <tr> <td>RC1242A0</td> <td>TERMINALE CHIUSO D10</td> <td>2.000</td> <td>PZ</td> </tr> <tr> <td>RC1356A0</td> <td>RACCORDO DRITTO FIL. FEMM 8X1/4 BSP</td> <td>1.000</td> <td>PZ</td> </tr> </tbody> </table>	Code	Description	Qty	UOM	0H2428A2	LAMIERA IMPIANTO LAVAGGIO XECC PLUS	1.000	PZ	EL1346A0	CLIP BLOCCA PINZETTA RACCORDI D10 TIERRE	2.000	PZ	EL1450A0	ELETTROVALV OLA H2O AUTOPULENT E BAF USA	3.000	PZ	GN1311A0	PASSACAVO GOMMA DE=25 DI=12 SP=6.5	1.000	PZ	GN1526A0	O-RING D.INT6.9 SP1.8	7.000	PZ	RC1018A0	FASCETTA ELASTICA D12 ZINCATA	5.000	PZ	RC1019A0	FASCETTA ELASTICA D10 ZINCATA	14.000	PZ	RC1130A0	FASCETTA 130X2.6	1.000	PZ	RC1131A0	FASCETTA 200X2.6 BIANC	1.000	PZ	RC1242A0	TERMINALE CHIUSO D10	2.000	PZ	RC1356A0	RACCORDO DRITTO FIL. FEMM 8X1/4 BSP	1.000	PZ
Code	Description	Qty	UOM																																															
0H2428A2	LAMIERA IMPIANTO LAVAGGIO XECC PLUS	1.000	PZ																																															
EL1346A0	CLIP BLOCCA PINZETTA RACCORDI D10 TIERRE	2.000	PZ																																															
EL1450A0	ELETTROVALV OLA H2O AUTOPULENT E BAF USA	3.000	PZ																																															
GN1311A0	PASSACAVO GOMMA DE=25 DI=12 SP=6.5	1.000	PZ																																															
GN1526A0	O-RING D.INT6.9 SP1.8	7.000	PZ																																															
RC1018A0	FASCETTA ELASTICA D12 ZINCATA	5.000	PZ																																															
RC1019A0	FASCETTA ELASTICA D10 ZINCATA	14.000	PZ																																															
RC1130A0	FASCETTA 130X2.6	1.000	PZ																																															
RC1131A0	FASCETTA 200X2.6 BIANC	1.000	PZ																																															
RC1242A0	TERMINALE CHIUSO D10	2.000	PZ																																															
RC1356A0	RACCORDO DRITTO FIL. FEMM 8X1/4 BSP	1.000	PZ																																															

COMPONENT			SPARE PART					
Code	Description	Image	Code	Description	Kit components			
VL1166A	RACCORDO A L BAM-BB6		KVL1213A	US PLUS COMPACT WASHING SYSTEM KIT	Code	Description	Qty	UOM
					RC1414A1	FASCETTA STRINGITUBO A SCATTO D11.5-12.5	4.000	PZ
					TB2821A0	TB2820A-L=40 MM EPDM NER	6.000	PZ
					TB3004A0	TB2820A-L=57 0MM EPDM NERO	2.000	PZ
					TB3005B0	TB3132A-L=55 0MM EPDM BIANCO BLU	1.000	PZ
					TB3252A0	TB3132A-L=23 0MM EPDM BIANCO BLU	1.000	PZ
					TB3469A0	TB3132A-L=38 0MM EPDM BIANCO-BLU	1.000	PZ
					VI1220A1	VITE AUTOFIL. 4.2X11 TCS+ MARUTEX	3.000	PZ
					VL1019A0	POMPA DETERGENTE VIBRAZIONE	1.000	PZ
					VL1047A1	PORTAGOMM A D6 CODOLO D8	1.000	PZ
					VL1054B0	DISTRIBUTOR E INGRESSI LAVAGGIO ON	1.000	PZ
					VL1102A1	FILTRO IN LINEA DET. + VNR BARBED 6 MM	1.000	PZ
					VL1127A1	RACCORDO A T BARBED 6	1.000	PZ
					VL1128A1	VALVOLA VNR BARBED D6	2.000	PZ
					VL1165A0	RACCORDO DRITTO BAM-BB6	1.000	PZ
					VL1166A0	RACCORDO A L BAM-BB6	3.000	PZ
					VL1174C0	UGELLO CALIBRATO D1.2 MM	1.000	PZ
					VL1185A0	DISTRIBUTOR E LAVAGGIO PLUS 2 VIE UGELLO	1.000	PZ
					VL1398A0	PRESSOSTAT O.N.O. 1/4 M CI	1.000	PZ
					VM2172A0	CLIP BLOCCAGGIO POMPA CON CIRCUITO	3.000	PZ

COMPONENT			SPARE PART																																																																														
Code	Description	Image	Code	Description	Kit components																																																																												
VL1166A	RACCORDO A L BAM-BB6		KVL1212A	EUR COMPACT PLUS CLEANING SYSTEM KIT	<table border="1"> <thead> <tr> <th>Code</th> <th>Description</th> <th>Qty</th> <th>UOM</th> </tr> </thead> <tbody> <tr> <td>0H2428A2</td> <td>LAMIERA IMPIANTO LAVAGGIO XECC PLUS</td> <td>1.000</td> <td>PZ</td> </tr> <tr> <td>EL1346A0</td> <td>CLIP BLOCCA PINZETTA RACCORDI D10 TIERRE</td> <td>2.000</td> <td>PZ</td> </tr> <tr> <td>EL1440A0</td> <td>ELETTROVALV OLA H2O AUTOPULENT E BAF EU</td> <td>3.000</td> <td>PZ</td> </tr> <tr> <td>GN1311A0</td> <td>PASSACAVO GOMMA DE=25 DI=12 SP=6.5</td> <td>1.000</td> <td>PZ</td> </tr> <tr> <td>GN1526A0</td> <td>O-RING D.INT6.9 SP1.8</td> <td>7.000</td> <td>PZ</td> </tr> <tr> <td>RC1018A0</td> <td>FASCETTA ELASTICA D12 ZINCATA</td> <td>5.000</td> <td>PZ</td> </tr> <tr> <td>RC1019A0</td> <td>FASCETTA ELASTICA D10 ZINCATA</td> <td>14.000</td> <td>PZ</td> </tr> <tr> <td>RC1130A0</td> <td>FASCETTA 130X2,6</td> <td>1.000</td> <td>PZ</td> </tr> <tr> <td>RC1131A0</td> <td>FASCETTA 200X2,6 BIANC</td> <td>1.000</td> <td>PZ</td> </tr> <tr> <td>RC1242A0</td> <td>TERMINALE CHIUSO D10</td> <td>2.000</td> <td>PZ</td> </tr> <tr> <td>RC1356A0</td> <td>RACCORDO DRITTO FIL. FEMM 8X1/4 BSP</td> <td>1.000</td> <td>PZ</td> </tr> <tr> <td>RC1414A1</td> <td>FASCETTA STRINGITUBO A SCATTO D11.5-12.5</td> <td>4.000</td> <td>PZ</td> </tr> <tr> <td>TB2821A0</td> <td>TB2820A-L=40 MM EPDM NER</td> <td>6.000</td> <td>PZ</td> </tr> <tr> <td>TB3004A0</td> <td>TB2820A-L=57 0MM EPDM NERO</td> <td>2.000</td> <td>PZ</td> </tr> <tr> <td>TB3005B0</td> <td>TB3132A-L=55 0MM EPDM BIANCO BLU</td> <td>1.000</td> <td>PZ</td> </tr> <tr> <td>TB3252A0</td> <td>TB3132A-L=23 0MM EPDM BIANCO BLU</td> <td>1.000</td> <td>PZ</td> </tr> <tr> <td>TB3469A0</td> <td>TB3132A-L=38 0MM EPDM BIANCO-BLU</td> <td>1.000</td> <td>PZ</td> </tr> <tr> <td>VH1220A1</td> <td>VITE AUTOFIL. 4.2X11 TCS+ MARUTEX</td> <td>3.000</td> <td>PZ</td> </tr> </tbody> </table>	Code	Description	Qty	UOM	0H2428A2	LAMIERA IMPIANTO LAVAGGIO XECC PLUS	1.000	PZ	EL1346A0	CLIP BLOCCA PINZETTA RACCORDI D10 TIERRE	2.000	PZ	EL1440A0	ELETTROVALV OLA H2O AUTOPULENT E BAF EU	3.000	PZ	GN1311A0	PASSACAVO GOMMA DE=25 DI=12 SP=6.5	1.000	PZ	GN1526A0	O-RING D.INT6.9 SP1.8	7.000	PZ	RC1018A0	FASCETTA ELASTICA D12 ZINCATA	5.000	PZ	RC1019A0	FASCETTA ELASTICA D10 ZINCATA	14.000	PZ	RC1130A0	FASCETTA 130X2,6	1.000	PZ	RC1131A0	FASCETTA 200X2,6 BIANC	1.000	PZ	RC1242A0	TERMINALE CHIUSO D10	2.000	PZ	RC1356A0	RACCORDO DRITTO FIL. FEMM 8X1/4 BSP	1.000	PZ	RC1414A1	FASCETTA STRINGITUBO A SCATTO D11.5-12.5	4.000	PZ	TB2821A0	TB2820A-L=40 MM EPDM NER	6.000	PZ	TB3004A0	TB2820A-L=57 0MM EPDM NERO	2.000	PZ	TB3005B0	TB3132A-L=55 0MM EPDM BIANCO BLU	1.000	PZ	TB3252A0	TB3132A-L=23 0MM EPDM BIANCO BLU	1.000	PZ	TB3469A0	TB3132A-L=38 0MM EPDM BIANCO-BLU	1.000	PZ	VH1220A1	VITE AUTOFIL. 4.2X11 TCS+ MARUTEX	3.000	PZ
Code	Description	Qty	UOM																																																																														
0H2428A2	LAMIERA IMPIANTO LAVAGGIO XECC PLUS	1.000	PZ																																																																														
EL1346A0	CLIP BLOCCA PINZETTA RACCORDI D10 TIERRE	2.000	PZ																																																																														
EL1440A0	ELETTROVALV OLA H2O AUTOPULENT E BAF EU	3.000	PZ																																																																														
GN1311A0	PASSACAVO GOMMA DE=25 DI=12 SP=6.5	1.000	PZ																																																																														
GN1526A0	O-RING D.INT6.9 SP1.8	7.000	PZ																																																																														
RC1018A0	FASCETTA ELASTICA D12 ZINCATA	5.000	PZ																																																																														
RC1019A0	FASCETTA ELASTICA D10 ZINCATA	14.000	PZ																																																																														
RC1130A0	FASCETTA 130X2,6	1.000	PZ																																																																														
RC1131A0	FASCETTA 200X2,6 BIANC	1.000	PZ																																																																														
RC1242A0	TERMINALE CHIUSO D10	2.000	PZ																																																																														
RC1356A0	RACCORDO DRITTO FIL. FEMM 8X1/4 BSP	1.000	PZ																																																																														
RC1414A1	FASCETTA STRINGITUBO A SCATTO D11.5-12.5	4.000	PZ																																																																														
TB2821A0	TB2820A-L=40 MM EPDM NER	6.000	PZ																																																																														
TB3004A0	TB2820A-L=57 0MM EPDM NERO	2.000	PZ																																																																														
TB3005B0	TB3132A-L=55 0MM EPDM BIANCO BLU	1.000	PZ																																																																														
TB3252A0	TB3132A-L=23 0MM EPDM BIANCO BLU	1.000	PZ																																																																														
TB3469A0	TB3132A-L=38 0MM EPDM BIANCO-BLU	1.000	PZ																																																																														
VH1220A1	VITE AUTOFIL. 4.2X11 TCS+ MARUTEX	3.000	PZ																																																																														

COMPONENT			SPARE PART																																																						
Code	Description	Image	Code	Description	Kit components																																																				
VL1166A	RACCORDO A L BAM-BB6		KVL1212A	EUR COMPACT PLUS CLEANING SYSTEM KIT	<table border="1"> <thead> <tr> <th>Code</th> <th>Description</th> <th>Qty</th> <th>UOM</th> </tr> </thead> <tbody> <tr> <td>VL1019A0</td> <td>POMPA DETERGENTE VIBRAZIONE</td> <td>1.000</td> <td>PZ</td> </tr> <tr> <td>VL1047A1</td> <td>PORTAGOMM A D6 CODOLO D8</td> <td>1.000</td> <td>PZ</td> </tr> <tr> <td>VL1054B0</td> <td>DISTRIBUTOR E INGRESSI LAVAGGIO ON</td> <td>1.000</td> <td>PZ</td> </tr> <tr> <td>VL1102A1</td> <td>FILTRO IN LINEA DET. + VNR BARBED 6 MM</td> <td>1.000</td> <td>PZ</td> </tr> <tr> <td>VL1127A1</td> <td>RACCORDO A T BARBED 6</td> <td>1.000</td> <td>PZ</td> </tr> <tr> <td>VL1128A1</td> <td>VALVOLA VNR BARBED D6</td> <td>2.000</td> <td>PZ</td> </tr> <tr> <td>VL1165A0</td> <td>RACCORDO DRITTO BAM-BB6</td> <td>1.000</td> <td>PZ</td> </tr> <tr> <td>VL1166A0</td> <td>RACCORDO A L BAM-BB6</td> <td>3.000</td> <td>PZ</td> </tr> <tr> <td>VL1174C0</td> <td>UGELLO CALIBRATO D1.2 MM</td> <td>1.000</td> <td>PZ</td> </tr> <tr> <td>VL1185A0</td> <td>DISTRIBUTOR E LAVAGGIO PLUS 2 VIE UGELLO</td> <td>1.000</td> <td>PZ</td> </tr> <tr> <td>VL1398A0</td> <td>PRESSOSTAT O.N.O. 1/4 M CI</td> <td>1.000</td> <td>PZ</td> </tr> <tr> <td>VM2172A0</td> <td>CLIP BLOCCAGGIO POMPA CON CIRCUITO</td> <td>3.000</td> <td>PZ</td> </tr> </tbody> </table>	Code	Description	Qty	UOM	VL1019A0	POMPA DETERGENTE VIBRAZIONE	1.000	PZ	VL1047A1	PORTAGOMM A D6 CODOLO D8	1.000	PZ	VL1054B0	DISTRIBUTOR E INGRESSI LAVAGGIO ON	1.000	PZ	VL1102A1	FILTRO IN LINEA DET. + VNR BARBED 6 MM	1.000	PZ	VL1127A1	RACCORDO A T BARBED 6	1.000	PZ	VL1128A1	VALVOLA VNR BARBED D6	2.000	PZ	VL1165A0	RACCORDO DRITTO BAM-BB6	1.000	PZ	VL1166A0	RACCORDO A L BAM-BB6	3.000	PZ	VL1174C0	UGELLO CALIBRATO D1.2 MM	1.000	PZ	VL1185A0	DISTRIBUTOR E LAVAGGIO PLUS 2 VIE UGELLO	1.000	PZ	VL1398A0	PRESSOSTAT O.N.O. 1/4 M CI	1.000	PZ	VM2172A0	CLIP BLOCCAGGIO POMPA CON CIRCUITO	3.000	PZ
Code	Description	Qty	UOM																																																						
VL1019A0	POMPA DETERGENTE VIBRAZIONE	1.000	PZ																																																						
VL1047A1	PORTAGOMM A D6 CODOLO D8	1.000	PZ																																																						
VL1054B0	DISTRIBUTOR E INGRESSI LAVAGGIO ON	1.000	PZ																																																						
VL1102A1	FILTRO IN LINEA DET. + VNR BARBED 6 MM	1.000	PZ																																																						
VL1127A1	RACCORDO A T BARBED 6	1.000	PZ																																																						
VL1128A1	VALVOLA VNR BARBED D6	2.000	PZ																																																						
VL1165A0	RACCORDO DRITTO BAM-BB6	1.000	PZ																																																						
VL1166A0	RACCORDO A L BAM-BB6	3.000	PZ																																																						
VL1174C0	UGELLO CALIBRATO D1.2 MM	1.000	PZ																																																						
VL1185A0	DISTRIBUTOR E LAVAGGIO PLUS 2 VIE UGELLO	1.000	PZ																																																						
VL1398A0	PRESSOSTAT O.N.O. 1/4 M CI	1.000	PZ																																																						
VM2172A0	CLIP BLOCCAGGIO POMPA CON CIRCUITO	3.000	PZ																																																						
			KVL1211A	ONE COMPACT AND 0523-EP WASH. SYSTEM KIT	<table border="1"> <thead> <tr> <th>Code</th> <th>Description</th> <th>Qty</th> <th>UOM</th> </tr> </thead> <tbody> <tr> <td>0H2427A0</td> <td>LAMIERA IMPIANTO LAVAGGIO XECC</td> <td>1.000</td> <td>PZ</td> </tr> <tr> <td>EL1346A0</td> <td>CLIP BLOCCA PINZETTA RACCORDI D10 TIERRE</td> <td>2.000</td> <td>PZ</td> </tr> <tr> <td>EL1440A0</td> <td>ELETTROVALV OLA H2O AUTOPULENT E BAF EU</td> <td>1.000</td> <td>PZ</td> </tr> <tr> <td>GN1526A0</td> <td>O-RING D.INT6.9 SP1.8</td> <td>3.000</td> <td>PZ</td> </tr> <tr> <td>RC1018A0</td> <td>FASCETTA ELASTICA D12 ZINCATA</td> <td>4.000</td> <td>PZ</td> </tr> </tbody> </table>	Code	Description	Qty	UOM	0H2427A0	LAMIERA IMPIANTO LAVAGGIO XECC	1.000	PZ	EL1346A0	CLIP BLOCCA PINZETTA RACCORDI D10 TIERRE	2.000	PZ	EL1440A0	ELETTROVALV OLA H2O AUTOPULENT E BAF EU	1.000	PZ	GN1526A0	O-RING D.INT6.9 SP1.8	3.000	PZ	RC1018A0	FASCETTA ELASTICA D12 ZINCATA	4.000	PZ																												
Code	Description	Qty	UOM																																																						
0H2427A0	LAMIERA IMPIANTO LAVAGGIO XECC	1.000	PZ																																																						
EL1346A0	CLIP BLOCCA PINZETTA RACCORDI D10 TIERRE	2.000	PZ																																																						
EL1440A0	ELETTROVALV OLA H2O AUTOPULENT E BAF EU	1.000	PZ																																																						
GN1526A0	O-RING D.INT6.9 SP1.8	3.000	PZ																																																						
RC1018A0	FASCETTA ELASTICA D12 ZINCATA	4.000	PZ																																																						

COMPONENT			SPARE PART			
Code	Description	Image	Code	Description	Kit components	
VL1166A	RACCORDO A L BAM-BB6		KVL1211A	ONE COMPACT AND 0523-EP WASH. SYSTEM KIT	Code	Description Qty UOM
					RC1019A0	FASCETTA 14.000 PZ ELASTICA D10 ZINCATA
					RC1130A0	FASCETTA 1.000 PZ 130X2,6
					RC1242A0	TERMINALE 2.000 PZ CHIUSO D10
					RC1414A1	FASCETTA 4.000 PZ STRINGITUBO A SCATTO D11.5-12.5
					TB2821A0	TB2820A-L=40 6.000 PZ MM EPDM NER
					TB3004A0	TB2820A-L=57 1.000 PZ 0MM EPDM NERO
					TB3252A0	TB3132A-L=23 1.000 PZ 0MM EPDM BIANCO BLU
					TB3469A0	TB3132A-L=38 1.000 PZ 0MM EPDM BIANCO-BLU
					VH1220A1	VITE AUTOFIL. 4.000 PZ 4.2X11 TCS+ MARUTEX
					VL1019A0	POMPA 1.000 PZ DETERGENTE VIBRAZIONE
					VL1047A1	PORTAGOMM 1.000 PZ A D6 CODOLO D8
					VL1054B0	DISTRIBUTOR 1.000 PZ E INGRESSI LAVAGGIO ON
					VL1102A1	FILTRO IN 1.000 PZ LINEA DET. + VNR BARBED 6 MM
					VL1127A1	RACCORDO A 1.000 PZ T BARBED 6
					VL1128A1	VALVOLA VNR 2.000 PZ BARBED D6
					VL1165A0	RACCORDO 1.000 PZ DRITTO BAM-BB6
					VL1166A0	RACCORDO A 1.000 PZ L BAM-BB6
					VL1174C0	UGELLO 1.000 PZ CALIBRATO D1.2 MM
					VL1191A0	DISTRIBUTOR 1.000 PZ E USCITA LAVAGGIO ON
					VM2172A0	CLIP 2.000 PZ BLOCCAGGIO POMPA CON CIRCUITO

COMPONENT			SPARE PART					
Code	Description	Image	Code	Description	Kit components			
VL1166A	RACCORDO A L BAM-BB6		KVL1209A	US PLUS 3 ROTOR ARMS WASHING SYSTEM KIT	Code	Description	Qty	UOM
					0H2354A2	LAMIERA IMPIANTO LAVAGGIO PLUS XEVC-XEVL	1.000	PZ
					EL1346A0	CLIP BLOCCA PINZETTA RACCORDI D10 TIERRE	2.000	PZ
					EL1450A0	ELETTROVALV OLA H2O AUTOPULENT E BAF USA	4.000	PZ
					GN1526A0	O-RING D.INT6.9 SP1.8	9.000	PZ
					RC1018A0	FASCETTA ELASTICA D12 ZINCATA	11.000	PZ
					RC1019A0	FASCETTA ELASTICA D10 ZINCATA	14.000	PZ
					RC1130A0	FASCETTA 130X2,6	1.000	PZ
					RC1131A0	FASCETTA 200X2,6 BIANC	3.000	PZ
					RC1242A0	TERMINALE CHIUSO D10	2.000	PZ
					RC1356A0	RACCORDO DRITTO FIL. FEMM 8X1/4 BSP	1.000	PZ
					RC1414A1	FASCETTA STRINGITUBO A SCATTO D11.5-12.5	1.000	PZ
					TB2652A0	TB3132A-L750 MM BIANCO BLU EPDM	1.000	PZ
					TB2677A0	TB2820A-TUB O TANICA DET-FDET L1300MM	1.000	PZ
					TB2821A0	TB2820A-L=40 MM EPDM NER	4.000	PZ
					TB3004A0	TB2820A-L=57 0MM EPDM NERO	2.000	PZ
					TB3024C0	TB3132A-TUB O BLU 6X12 L=55MM	3.000	PZ
					TB3226A0	TB2820A-L110 MM COLLEGAMEN TO TANICA-LA	1.000	PZ





COMPONENT			SPARE PART																																																																																	
Code	Description	Image	Code	Description	Kit components																																																																															
VL1166A	RACCORDO A L BAM-BB6		KVL1209A	US PLUS 3 ROTOR ARMS WASHING SYSTEM KIT	<table border="1"> <thead> <tr> <th>Code</th> <th>Description</th> <th>Qty</th> <th>UOM</th> </tr> </thead> <tbody> <tr> <td>TB3440A0</td> <td>TB3132A-L=10 50MM EPDM BIANCO-BLU</td> <td>1.000</td> <td>PZ</td> </tr> <tr> <td>TB3614A0</td> <td>TB2820A-L=96 MM NERO EPD</td> <td>1.000</td> <td>PZ</td> </tr> <tr> <td>VI1220A1</td> <td>VITE AUTOFIL. 4.2X11 TCS+ MARUTEX</td> <td>1.000</td> <td>PZ</td> </tr> <tr> <td>VL1019A0</td> <td>POMPA DETERGENTE VIBRAZIONE</td> <td>1.000</td> <td>PZ</td> </tr> <tr> <td>VL1102A1</td> <td>FILTRO IN LINEA DET. + VNR BARBED 6 MM</td> <td>1.000</td> <td>PZ</td> </tr> <tr> <td>VL1127A1</td> <td>RACCORDO A T BARBED 6</td> <td>2.000</td> <td>PZ</td> </tr> <tr> <td>VL1128A1</td> <td>VALVOLA VNR BARBED D6</td> <td>2.000</td> <td>PZ</td> </tr> <tr> <td>VL1166A0</td> <td>RACCORDO A L BAM-BB6</td> <td>4.000</td> <td>PZ</td> </tr> <tr> <td>VL1167A2</td> <td>FLOW RESTRICTOR 3 GIRANTI GN21 B-B</td> <td>1.000</td> <td>PZ</td> </tr> <tr> <td>VL1174C0</td> <td>UGELLO CALIBRATO D1.2 MM</td> <td>1.000</td> <td>PZ</td> </tr> <tr> <td>VL1186A0</td> <td>DISTRIBUTOR E LAVAGGIO PLUS 3 VIE UGELLO</td> <td>1.000</td> <td>PZ</td> </tr> <tr> <td>VL1190A0</td> <td>DISTRIBUTOR E INGRESSI LAVAGGIO PLUS</td> <td>1.000</td> <td>PZ</td> </tr> <tr> <td>VL1214A0</td> <td>VALVOLA VNR BB6-BAIONET TA</td> <td>1.000</td> <td>PZ</td> </tr> <tr> <td>VL1398A0</td> <td>PRESSOSTAT O.N.O. 1/4 M CI</td> <td>1.000</td> <td>PZ</td> </tr> <tr> <td>VM1605A0</td> <td>CLIP TWIST LOCK DIAM. 10,2-12,7 MM</td> <td>3.000</td> <td>PZ</td> </tr> <tr> <td>VM2172A0</td> <td>CLIP BLOCCAGGIO POMPA CON CIRCUITO</td> <td>5.000</td> <td>PZ</td> </tr> </tbody> </table>	Code	Description	Qty	UOM	TB3440A0	TB3132A-L=10 50MM EPDM BIANCO-BLU	1.000	PZ	TB3614A0	TB2820A-L=96 MM NERO EPD	1.000	PZ	VI1220A1	VITE AUTOFIL. 4.2X11 TCS+ MARUTEX	1.000	PZ	VL1019A0	POMPA DETERGENTE VIBRAZIONE	1.000	PZ	VL1102A1	FILTRO IN LINEA DET. + VNR BARBED 6 MM	1.000	PZ	VL1127A1	RACCORDO A T BARBED 6	2.000	PZ	VL1128A1	VALVOLA VNR BARBED D6	2.000	PZ	VL1166A0	RACCORDO A L BAM-BB6	4.000	PZ	VL1167A2	FLOW RESTRICTOR 3 GIRANTI GN21 B-B	1.000	PZ	VL1174C0	UGELLO CALIBRATO D1.2 MM	1.000	PZ	VL1186A0	DISTRIBUTOR E LAVAGGIO PLUS 3 VIE UGELLO	1.000	PZ	VL1190A0	DISTRIBUTOR E INGRESSI LAVAGGIO PLUS	1.000	PZ	VL1214A0	VALVOLA VNR BB6-BAIONET TA	1.000	PZ	VL1398A0	PRESSOSTAT O.N.O. 1/4 M CI	1.000	PZ	VM1605A0	CLIP TWIST LOCK DIAM. 10,2-12,7 MM	3.000	PZ	VM2172A0	CLIP BLOCCAGGIO POMPA CON CIRCUITO	5.000	PZ	KVL1208A	US PLUS 2 ROTOR ARMS WASHING SYSTEM KIT	<table border="1"> <thead> <tr> <th>Code</th> <th>Description</th> <th>Qty</th> <th>UOM</th> </tr> </thead> <tbody> <tr> <td>0H2354A2</td> <td>LAMIERA IMPIANTO LAVAGGIO PLUS XEVC-XEVL</td> <td>1.000</td> <td>PZ</td> </tr> </tbody> </table>	Code	Description	Qty	UOM	0H2354A2	LAMIERA IMPIANTO LAVAGGIO PLUS XEVC-XEVL	1.000	PZ
			Code		Description	Qty	UOM																																																																													
TB3440A0	TB3132A-L=10 50MM EPDM BIANCO-BLU	1.000	PZ																																																																																	
TB3614A0	TB2820A-L=96 MM NERO EPD	1.000	PZ																																																																																	
VI1220A1	VITE AUTOFIL. 4.2X11 TCS+ MARUTEX	1.000	PZ																																																																																	
VL1019A0	POMPA DETERGENTE VIBRAZIONE	1.000	PZ																																																																																	
VL1102A1	FILTRO IN LINEA DET. + VNR BARBED 6 MM	1.000	PZ																																																																																	
VL1127A1	RACCORDO A T BARBED 6	2.000	PZ																																																																																	
VL1128A1	VALVOLA VNR BARBED D6	2.000	PZ																																																																																	
VL1166A0	RACCORDO A L BAM-BB6	4.000	PZ																																																																																	
VL1167A2	FLOW RESTRICTOR 3 GIRANTI GN21 B-B	1.000	PZ																																																																																	
VL1174C0	UGELLO CALIBRATO D1.2 MM	1.000	PZ																																																																																	
VL1186A0	DISTRIBUTOR E LAVAGGIO PLUS 3 VIE UGELLO	1.000	PZ																																																																																	
VL1190A0	DISTRIBUTOR E INGRESSI LAVAGGIO PLUS	1.000	PZ																																																																																	
VL1214A0	VALVOLA VNR BB6-BAIONET TA	1.000	PZ																																																																																	
VL1398A0	PRESSOSTAT O.N.O. 1/4 M CI	1.000	PZ																																																																																	
VM1605A0	CLIP TWIST LOCK DIAM. 10,2-12,7 MM	3.000	PZ																																																																																	
VM2172A0	CLIP BLOCCAGGIO POMPA CON CIRCUITO	5.000	PZ																																																																																	
Code	Description	Qty	UOM																																																																																	
0H2354A2	LAMIERA IMPIANTO LAVAGGIO PLUS XEVC-XEVL	1.000	PZ																																																																																	

COMPONENT			SPARE PART																																																																														
Code	Description	Image	Code	Description	Kit components																																																																												
VL1166A	RACCORDO A L BAM-BB6		KVL1208A	US PLUS 2 ROTOR ARMS WASHING SYSTEM KIT	<table border="1"> <thead> <tr> <th>Code</th> <th>Description</th> <th>Qty</th> <th>UOM</th> </tr> </thead> <tbody> <tr> <td>EL1346A0</td> <td>CLIP BLOCCA PINZETTA RACCORDI D10 TIERRE</td> <td>2.000</td> <td>PZ</td> </tr> <tr> <td>EL1450A0</td> <td>ELETTROVALV OLA H2O AUTOPULENT E BAF USA</td> <td>4.000</td> <td>PZ</td> </tr> <tr> <td>GN1526A0</td> <td>O-RING D.INT6.9 SP1.8</td> <td>9.000</td> <td>PZ</td> </tr> <tr> <td>RC1018A0</td> <td>FASCETTA ELASTICA D12 ZINCATA</td> <td>3.000</td> <td>PZ</td> </tr> <tr> <td>RC1019A0</td> <td>FASCETTA ELASTICA D10 ZINCATA</td> <td>2.000</td> <td>PZ</td> </tr> <tr> <td>RC1130A0</td> <td>FASCETTA 130X2,6</td> <td>1.000</td> <td>PZ</td> </tr> <tr> <td>RC1131A0</td> <td>FASCETTA 200X2,6 BIANC</td> <td>3.000</td> <td>PZ</td> </tr> <tr> <td>RC1242A0</td> <td>TERMINALE CHIUSO D10</td> <td>2.000</td> <td>PZ</td> </tr> <tr> <td>RC1356A0</td> <td>RACCORDO DRITTO FIL. FEMM 8X1/4 BSP</td> <td>1.000</td> <td>PZ</td> </tr> <tr> <td>RC1414A1</td> <td>FASCETTA STRINGITUBO A SCATTO D11,5-12,5</td> <td>4.000</td> <td>PZ</td> </tr> <tr> <td>TB2821A0</td> <td>TB2820A-L=40 MM EPDM NER</td> <td>6.000</td> <td>PZ</td> </tr> <tr> <td>TB2994A0</td> <td>TB2820A-TUB O EPDM NERO 1000MM</td> <td>1.000</td> <td>PZ</td> </tr> <tr> <td>TB3004A0</td> <td>TB2820A-L=57 0MM EPDM NERO</td> <td>2.000</td> <td>PZ</td> </tr> <tr> <td>TB3005B0</td> <td>TB3132A-L=55 0MM EPDM BIANCO BLU</td> <td>1.000</td> <td>PZ</td> </tr> <tr> <td>TB3440A0</td> <td>TB3132A-L=10 50MM EPDM BIANCO-BLU</td> <td>1.000</td> <td>PZ</td> </tr> <tr> <td>VL1019A0</td> <td>POMPA DETERGENTE VIBRAZIONE</td> <td>1.000</td> <td>PZ</td> </tr> <tr> <td>VL1047A1</td> <td>PORTAGOMM A D6 CODOLO D8</td> <td>1.000</td> <td>PZ</td> </tr> <tr> <td>VL1102A1</td> <td>FILTRO IN LINEA DET. + VNR BARBED 6 MM</td> <td>1.000</td> <td>PZ</td> </tr> </tbody> </table>	Code	Description	Qty	UOM	EL1346A0	CLIP BLOCCA PINZETTA RACCORDI D10 TIERRE	2.000	PZ	EL1450A0	ELETTROVALV OLA H2O AUTOPULENT E BAF USA	4.000	PZ	GN1526A0	O-RING D.INT6.9 SP1.8	9.000	PZ	RC1018A0	FASCETTA ELASTICA D12 ZINCATA	3.000	PZ	RC1019A0	FASCETTA ELASTICA D10 ZINCATA	2.000	PZ	RC1130A0	FASCETTA 130X2,6	1.000	PZ	RC1131A0	FASCETTA 200X2,6 BIANC	3.000	PZ	RC1242A0	TERMINALE CHIUSO D10	2.000	PZ	RC1356A0	RACCORDO DRITTO FIL. FEMM 8X1/4 BSP	1.000	PZ	RC1414A1	FASCETTA STRINGITUBO A SCATTO D11,5-12,5	4.000	PZ	TB2821A0	TB2820A-L=40 MM EPDM NER	6.000	PZ	TB2994A0	TB2820A-TUB O EPDM NERO 1000MM	1.000	PZ	TB3004A0	TB2820A-L=57 0MM EPDM NERO	2.000	PZ	TB3005B0	TB3132A-L=55 0MM EPDM BIANCO BLU	1.000	PZ	TB3440A0	TB3132A-L=10 50MM EPDM BIANCO-BLU	1.000	PZ	VL1019A0	POMPA DETERGENTE VIBRAZIONE	1.000	PZ	VL1047A1	PORTAGOMM A D6 CODOLO D8	1.000	PZ	VL1102A1	FILTRO IN LINEA DET. + VNR BARBED 6 MM	1.000	PZ
Code	Description	Qty	UOM																																																																														
EL1346A0	CLIP BLOCCA PINZETTA RACCORDI D10 TIERRE	2.000	PZ																																																																														
EL1450A0	ELETTROVALV OLA H2O AUTOPULENT E BAF USA	4.000	PZ																																																																														
GN1526A0	O-RING D.INT6.9 SP1.8	9.000	PZ																																																																														
RC1018A0	FASCETTA ELASTICA D12 ZINCATA	3.000	PZ																																																																														
RC1019A0	FASCETTA ELASTICA D10 ZINCATA	2.000	PZ																																																																														
RC1130A0	FASCETTA 130X2,6	1.000	PZ																																																																														
RC1131A0	FASCETTA 200X2,6 BIANC	3.000	PZ																																																																														
RC1242A0	TERMINALE CHIUSO D10	2.000	PZ																																																																														
RC1356A0	RACCORDO DRITTO FIL. FEMM 8X1/4 BSP	1.000	PZ																																																																														
RC1414A1	FASCETTA STRINGITUBO A SCATTO D11,5-12,5	4.000	PZ																																																																														
TB2821A0	TB2820A-L=40 MM EPDM NER	6.000	PZ																																																																														
TB2994A0	TB2820A-TUB O EPDM NERO 1000MM	1.000	PZ																																																																														
TB3004A0	TB2820A-L=57 0MM EPDM NERO	2.000	PZ																																																																														
TB3005B0	TB3132A-L=55 0MM EPDM BIANCO BLU	1.000	PZ																																																																														
TB3440A0	TB3132A-L=10 50MM EPDM BIANCO-BLU	1.000	PZ																																																																														
VL1019A0	POMPA DETERGENTE VIBRAZIONE	1.000	PZ																																																																														
VL1047A1	PORTAGOMM A D6 CODOLO D8	1.000	PZ																																																																														
VL1102A1	FILTRO IN LINEA DET. + VNR BARBED 6 MM	1.000	PZ																																																																														

COMPONENT			SPARE PART																																														
Code	Description	Image	Code	Description	Kit components																																												
VL1166A	RACCORDO A L BAM-BB6		KVL1208A	US PLUS 2 ROTOR ARMS WASHING SYSTEM KIT	<table border="1"> <thead> <tr> <th>Code</th> <th>Description</th> <th>Qty</th> <th>UOM</th> </tr> </thead> <tbody> <tr> <td>VL1128A1</td> <td>VALVOLA VNR BARBED D6</td> <td>2.000</td> <td>PZ</td> </tr> <tr> <td>VL1141A1</td> <td>RACCORDO DRITTO BB6-BB6</td> <td>1.000</td> <td>PZ</td> </tr> <tr> <td>VL1166A0</td> <td>RACCORDO A L BAM-BB6</td> <td>4.000</td> <td>PZ</td> </tr> <tr> <td>VL1174C0</td> <td>UGELLO CALIBRATO D1.2 MM</td> <td>1.000</td> <td>PZ</td> </tr> <tr> <td>VL1186A0</td> <td>DISTRIBUTOR E LAVAGGIO PLUS 3 VIE UGELLO</td> <td>1.000</td> <td>PZ</td> </tr> <tr> <td>VL1190A0</td> <td>DISTRIBUTOR E INGRESSI LAVAGGIO PLUS</td> <td>1.000</td> <td>PZ</td> </tr> <tr> <td>VL1214A0</td> <td>VALVOLA VNR BB6-BAIONET TA</td> <td>1.000</td> <td>PZ</td> </tr> <tr> <td>VL1398A0</td> <td>PRESSOSTAT O.N.O. 1/4 M CI</td> <td>1.000</td> <td>PZ</td> </tr> <tr> <td>VM1605A0</td> <td>CLIP TWIST LOCK DIAM. 10,2-12,7 MM</td> <td>3.000</td> <td>PZ</td> </tr> <tr> <td>VM2172A0</td> <td>CLIP BLOCCAGGIO POMPA CON CIRCUITO</td> <td>5.000</td> <td>PZ</td> </tr> </tbody> </table>	Code	Description	Qty	UOM	VL1128A1	VALVOLA VNR BARBED D6	2.000	PZ	VL1141A1	RACCORDO DRITTO BB6-BB6	1.000	PZ	VL1166A0	RACCORDO A L BAM-BB6	4.000	PZ	VL1174C0	UGELLO CALIBRATO D1.2 MM	1.000	PZ	VL1186A0	DISTRIBUTOR E LAVAGGIO PLUS 3 VIE UGELLO	1.000	PZ	VL1190A0	DISTRIBUTOR E INGRESSI LAVAGGIO PLUS	1.000	PZ	VL1214A0	VALVOLA VNR BB6-BAIONET TA	1.000	PZ	VL1398A0	PRESSOSTAT O.N.O. 1/4 M CI	1.000	PZ	VM1605A0	CLIP TWIST LOCK DIAM. 10,2-12,7 MM	3.000	PZ	VM2172A0	CLIP BLOCCAGGIO POMPA CON CIRCUITO	5.000	PZ
			Code	Description	Qty	UOM																																											
VL1128A1	VALVOLA VNR BARBED D6	2.000	PZ																																														
VL1141A1	RACCORDO DRITTO BB6-BB6	1.000	PZ																																														
VL1166A0	RACCORDO A L BAM-BB6	4.000	PZ																																														
VL1174C0	UGELLO CALIBRATO D1.2 MM	1.000	PZ																																														
VL1186A0	DISTRIBUTOR E LAVAGGIO PLUS 3 VIE UGELLO	1.000	PZ																																														
VL1190A0	DISTRIBUTOR E INGRESSI LAVAGGIO PLUS	1.000	PZ																																														
VL1214A0	VALVOLA VNR BB6-BAIONET TA	1.000	PZ																																														
VL1398A0	PRESSOSTAT O.N.O. 1/4 M CI	1.000	PZ																																														
VM1605A0	CLIP TWIST LOCK DIAM. 10,2-12,7 MM	3.000	PZ																																														
VM2172A0	CLIP BLOCCAGGIO POMPA CON CIRCUITO	5.000	PZ																																														
KVL1207A	US PLUS 1 ROTOR ARM WASHING SYSTEM KIT	<table border="1"> <thead> <tr> <th>Code</th> <th>Description</th> <th>Qty</th> <th>UOM</th> </tr> </thead> <tbody> <tr> <td>0H2354A2</td> <td>LAMIERA IMPIANTO LAVAGGIO PLUS XEVC-XEVL</td> <td>1.000</td> <td>PZ</td> </tr> <tr> <td>EL1346A0</td> <td>CLIP BLOCCA PINZETTA RACCORDI D10 TIERRE</td> <td>2.000</td> <td>PZ</td> </tr> <tr> <td>EL1450A0</td> <td>ELETTROVALV OLA H2O AUTOPULENT E BAF USA</td> <td>3.000</td> <td>PZ</td> </tr> <tr> <td>GN1526A0</td> <td>O-RING D.INT6.9 SP1.8</td> <td>7.000</td> <td>PZ</td> </tr> <tr> <td>RC1018A0</td> <td>FASCETTA ELASTICA D12 ZINCATA</td> <td>1.000</td> <td>PZ</td> </tr> <tr> <td>RC1019A0</td> <td>FASCETTA ELASTICA D10 ZINCATA</td> <td>12.000</td> <td>PZ</td> </tr> <tr> <td>RC1130A0</td> <td>FASCETTA 130X2,6</td> <td>1.000</td> <td>PZ</td> </tr> </tbody> </table>	Code	Description	Qty	UOM	0H2354A2	LAMIERA IMPIANTO LAVAGGIO PLUS XEVC-XEVL	1.000	PZ	EL1346A0	CLIP BLOCCA PINZETTA RACCORDI D10 TIERRE	2.000	PZ	EL1450A0	ELETTROVALV OLA H2O AUTOPULENT E BAF USA	3.000	PZ	GN1526A0	O-RING D.INT6.9 SP1.8	7.000	PZ	RC1018A0	FASCETTA ELASTICA D12 ZINCATA	1.000	PZ	RC1019A0	FASCETTA ELASTICA D10 ZINCATA	12.000	PZ	RC1130A0	FASCETTA 130X2,6	1.000	PZ															
Code	Description	Qty	UOM																																														
0H2354A2	LAMIERA IMPIANTO LAVAGGIO PLUS XEVC-XEVL	1.000	PZ																																														
EL1346A0	CLIP BLOCCA PINZETTA RACCORDI D10 TIERRE	2.000	PZ																																														
EL1450A0	ELETTROVALV OLA H2O AUTOPULENT E BAF USA	3.000	PZ																																														
GN1526A0	O-RING D.INT6.9 SP1.8	7.000	PZ																																														
RC1018A0	FASCETTA ELASTICA D12 ZINCATA	1.000	PZ																																														
RC1019A0	FASCETTA ELASTICA D10 ZINCATA	12.000	PZ																																														
RC1130A0	FASCETTA 130X2,6	1.000	PZ																																														

COMPONENT			SPARE PART																																																																																		
Code	Description	Image	Code	Description	Kit components																																																																																
VL1166A	RACCORDO A L		KVL1207A	US PLUS 1 ROTOR ARM WASHING SYSTEM KIT	<table border="1"> <thead> <tr> <th>Code</th> <th>Description</th> <th>Qty</th> <th>UOM</th> </tr> </thead> <tbody> <tr> <td>RC1131A0</td> <td>FASCETTA 200X2,6 BIANC</td> <td>2.000</td> <td>PZ</td> </tr> <tr> <td>RC1242A0</td> <td>TERMINALE CHIUSO D10</td> <td>2.000</td> <td>PZ</td> </tr> <tr> <td>RC1356A0</td> <td>RACCORDO DRITTO FIL. FEMM 8X1/4 BSP</td> <td>1.000</td> <td>PZ</td> </tr> <tr> <td>RC1414A1</td> <td>FASCETTA STRINGITUBO A SCATTO D11,5-12,5</td> <td>4.000</td> <td>PZ</td> </tr> <tr> <td>TB2821A0</td> <td>TB2820A-L=40 MM EPDM NER</td> <td>4.000</td> <td>PZ</td> </tr> <tr> <td>TB3004A0</td> <td>TB2820A-L=57 0MM EPDM NERO</td> <td>1.000</td> <td>PZ</td> </tr> <tr> <td>TB3005B0</td> <td>TB3132A-L=55 0MM EPDM BIANCO BLU</td> <td>2.000</td> <td>PZ</td> </tr> <tr> <td>TB3024C0</td> <td>TB3132A-TUB O BLU 6X12 L=55MM</td> <td>1.000</td> <td>PZ</td> </tr> <tr> <td>TB3225B0</td> <td>TB2820A-TUB O EPDM NERO 670MM</td> <td>1.000</td> <td>PZ</td> </tr> <tr> <td>TB3252A0</td> <td>TB3132A-L=23 0MM EPDM BIANCO BLU</td> <td>1.000</td> <td>PZ</td> </tr> <tr> <td>TB3614A0</td> <td>TB2820A-L=96 MM NERO EPD</td> <td>1.000</td> <td>PZ</td> </tr> <tr> <td>VH1220A1</td> <td>VITE AUTOFIL. 4.2X11 TCS+ MARUTEX</td> <td>1.000</td> <td>PZ</td> </tr> <tr> <td>VL1019A0</td> <td>POMPA DETERGENTE VIBRAZIONE</td> <td>1.000</td> <td>PZ</td> </tr> <tr> <td>VL1047A1</td> <td>PORTAGOMM A D6 CODOLO D8</td> <td>1.000</td> <td>PZ</td> </tr> <tr> <td>VL1102A1</td> <td>FILTRO IN LINEA DET. + VNR BARBED 6 MM</td> <td>1.000</td> <td>PZ</td> </tr> <tr> <td>VL1127A1</td> <td>RACCORDO A T BARBED 6</td> <td>1.000</td> <td>PZ</td> </tr> <tr> <td>VL1128A1</td> <td>VALVOLA VNR BARBED D6</td> <td>1.000</td> <td>PZ</td> </tr> <tr> <td>VL1166A0</td> <td>RACCORDO A L BAM-BB6</td> <td>3.000</td> <td>PZ</td> </tr> <tr> <td>VL1174C0</td> <td>UGELLO CALIBRATO D1.2 MM</td> <td>1.000</td> <td>PZ</td> </tr> </tbody> </table>	Code	Description	Qty	UOM	RC1131A0	FASCETTA 200X2,6 BIANC	2.000	PZ	RC1242A0	TERMINALE CHIUSO D10	2.000	PZ	RC1356A0	RACCORDO DRITTO FIL. FEMM 8X1/4 BSP	1.000	PZ	RC1414A1	FASCETTA STRINGITUBO A SCATTO D11,5-12,5	4.000	PZ	TB2821A0	TB2820A-L=40 MM EPDM NER	4.000	PZ	TB3004A0	TB2820A-L=57 0MM EPDM NERO	1.000	PZ	TB3005B0	TB3132A-L=55 0MM EPDM BIANCO BLU	2.000	PZ	TB3024C0	TB3132A-TUB O BLU 6X12 L=55MM	1.000	PZ	TB3225B0	TB2820A-TUB O EPDM NERO 670MM	1.000	PZ	TB3252A0	TB3132A-L=23 0MM EPDM BIANCO BLU	1.000	PZ	TB3614A0	TB2820A-L=96 MM NERO EPD	1.000	PZ	VH1220A1	VITE AUTOFIL. 4.2X11 TCS+ MARUTEX	1.000	PZ	VL1019A0	POMPA DETERGENTE VIBRAZIONE	1.000	PZ	VL1047A1	PORTAGOMM A D6 CODOLO D8	1.000	PZ	VL1102A1	FILTRO IN LINEA DET. + VNR BARBED 6 MM	1.000	PZ	VL1127A1	RACCORDO A T BARBED 6	1.000	PZ	VL1128A1	VALVOLA VNR BARBED D6	1.000	PZ	VL1166A0	RACCORDO A L BAM-BB6	3.000	PZ	VL1174C0	UGELLO CALIBRATO D1.2 MM	1.000	PZ
	Code				Description	Qty	UOM																																																																														
RC1131A0	FASCETTA 200X2,6 BIANC	2.000	PZ																																																																																		
RC1242A0	TERMINALE CHIUSO D10	2.000	PZ																																																																																		
RC1356A0	RACCORDO DRITTO FIL. FEMM 8X1/4 BSP	1.000	PZ																																																																																		
RC1414A1	FASCETTA STRINGITUBO A SCATTO D11,5-12,5	4.000	PZ																																																																																		
TB2821A0	TB2820A-L=40 MM EPDM NER	4.000	PZ																																																																																		
TB3004A0	TB2820A-L=57 0MM EPDM NERO	1.000	PZ																																																																																		
TB3005B0	TB3132A-L=55 0MM EPDM BIANCO BLU	2.000	PZ																																																																																		
TB3024C0	TB3132A-TUB O BLU 6X12 L=55MM	1.000	PZ																																																																																		
TB3225B0	TB2820A-TUB O EPDM NERO 670MM	1.000	PZ																																																																																		
TB3252A0	TB3132A-L=23 0MM EPDM BIANCO BLU	1.000	PZ																																																																																		
TB3614A0	TB2820A-L=96 MM NERO EPD	1.000	PZ																																																																																		
VH1220A1	VITE AUTOFIL. 4.2X11 TCS+ MARUTEX	1.000	PZ																																																																																		
VL1019A0	POMPA DETERGENTE VIBRAZIONE	1.000	PZ																																																																																		
VL1047A1	PORTAGOMM A D6 CODOLO D8	1.000	PZ																																																																																		
VL1102A1	FILTRO IN LINEA DET. + VNR BARBED 6 MM	1.000	PZ																																																																																		
VL1127A1	RACCORDO A T BARBED 6	1.000	PZ																																																																																		
VL1128A1	VALVOLA VNR BARBED D6	1.000	PZ																																																																																		
VL1166A0	RACCORDO A L BAM-BB6	3.000	PZ																																																																																		
VL1174C0	UGELLO CALIBRATO D1.2 MM	1.000	PZ																																																																																		

COMPONENT			SPARE PART																																															
Code	Description	Image	Code	Description	Kit components																																													
VL1166A	RACCORDO A L BAM-BB6		KVL1207A	US PLUS 1 ROTOR ARM WASHING SYSTEM KIT	<table border="1"> <thead> <tr> <th>Code</th> <th>Description</th> <th>Qty</th> <th>UOM</th> </tr> </thead> <tbody> <tr> <td>VL1185A0</td> <td>DISTRIBUTOR E LAVAGGIO PLUS 2 VIE UGELLO</td> <td>1.000</td> <td>PZ</td> </tr> <tr> <td>VL1190A0</td> <td>DISTRIBUTOR E INGRESSI LAVAGGIO PLUS</td> <td>1.000</td> <td>PZ</td> </tr> <tr> <td>VL1214A0</td> <td>VALVOLA VNR BB6-BAIONET TA</td> <td>1.000</td> <td>PZ</td> </tr> <tr> <td>VL1398A0</td> <td>PRESSOSTAT O.N.O. 1/4 M CI</td> <td>1.000</td> <td>PZ</td> </tr> <tr> <td>VM1605A0</td> <td>CLIP TWIST LOCK DIAM. 10,2-12,7 MM</td> <td>3.000</td> <td>PZ</td> </tr> <tr> <td>VM2172A0</td> <td>CLIP BLOCCAGGIO POMPA CON CIRCUITO</td> <td>4.000</td> <td>PZ</td> </tr> </tbody> </table>	Code	Description	Qty	UOM	VL1185A0	DISTRIBUTOR E LAVAGGIO PLUS 2 VIE UGELLO	1.000	PZ	VL1190A0	DISTRIBUTOR E INGRESSI LAVAGGIO PLUS	1.000	PZ	VL1214A0	VALVOLA VNR BB6-BAIONET TA	1.000	PZ	VL1398A0	PRESSOSTAT O.N.O. 1/4 M CI	1.000	PZ	VM1605A0	CLIP TWIST LOCK DIAM. 10,2-12,7 MM	3.000	PZ	VM2172A0	CLIP BLOCCAGGIO POMPA CON CIRCUITO	4.000	PZ																	
			Code		Description	Qty	UOM																																											
VL1185A0	DISTRIBUTOR E LAVAGGIO PLUS 2 VIE UGELLO	1.000	PZ																																															
VL1190A0	DISTRIBUTOR E INGRESSI LAVAGGIO PLUS	1.000	PZ																																															
VL1214A0	VALVOLA VNR BB6-BAIONET TA	1.000	PZ																																															
VL1398A0	PRESSOSTAT O.N.O. 1/4 M CI	1.000	PZ																																															
VM1605A0	CLIP TWIST LOCK DIAM. 10,2-12,7 MM	3.000	PZ																																															
VM2172A0	CLIP BLOCCAGGIO POMPA CON CIRCUITO	4.000	PZ																																															
KVL1198A	MM EU HOOD CLEANING SYSTEM KIT	<table border="1"> <thead> <tr> <th>Code</th> <th>Description</th> <th>Qty</th> <th>UOM</th> </tr> </thead> <tbody> <tr> <td>0H2213A1</td> <td>LAMIERA IMPIANTO IDRICO CAPPA</td> <td>1.000</td> <td>PZ</td> </tr> <tr> <td>EL1346A0</td> <td>CLIP BLOCCA PINZETTA RACCORDI D10 TIERRE</td> <td>2.000</td> <td>PZ</td> </tr> <tr> <td>EL1440A0</td> <td>ELETTROVALV OLA H2O AUTOPULENT E BAF EU</td> <td>2.000</td> <td>PZ</td> </tr> <tr> <td>GN1526A0</td> <td>O-RING D.INT6,9 SP1.8</td> <td>5.000</td> <td>PZ</td> </tr> <tr> <td>RC1018A0</td> <td>FASCETTA ELASTICA D12 ZINCATA</td> <td>1.000</td> <td>PZ</td> </tr> <tr> <td>RC1019A0</td> <td>FASCETTA ELASTICA D10 ZINCATA</td> <td>14.000</td> <td>PZ</td> </tr> <tr> <td>RC1131A0</td> <td>FASCETTA 200X2,6 BIANC</td> <td>1.000</td> <td>PZ</td> </tr> <tr> <td>RC1242A0</td> <td>TERMINALE CHIUSO D10</td> <td>2.000</td> <td>PZ</td> </tr> <tr> <td>RC1414A1</td> <td>FASCETTA STRINGITUBO A SCATTO D11,5-12,5</td> <td>5.000</td> <td>PZ</td> </tr> <tr> <td>TB2821A0</td> <td>TB2820A-L=40 MM EPDM NER</td> <td>4.000</td> <td>PZ</td> </tr> <tr> <td>TB2994A0</td> <td>TB2820A-TUB O EPDM NERO 1000MM</td> <td>2.000</td> <td>PZ</td> </tr> </tbody> </table>	Code	Description	Qty	UOM	0H2213A1	LAMIERA IMPIANTO IDRICO CAPPA	1.000	PZ	EL1346A0	CLIP BLOCCA PINZETTA RACCORDI D10 TIERRE	2.000	PZ	EL1440A0	ELETTROVALV OLA H2O AUTOPULENT E BAF EU	2.000	PZ	GN1526A0	O-RING D.INT6,9 SP1.8	5.000	PZ	RC1018A0	FASCETTA ELASTICA D12 ZINCATA	1.000	PZ	RC1019A0	FASCETTA ELASTICA D10 ZINCATA	14.000	PZ	RC1131A0	FASCETTA 200X2,6 BIANC	1.000	PZ	RC1242A0	TERMINALE CHIUSO D10	2.000	PZ	RC1414A1	FASCETTA STRINGITUBO A SCATTO D11,5-12,5	5.000	PZ	TB2821A0	TB2820A-L=40 MM EPDM NER	4.000	PZ	TB2994A0	TB2820A-TUB O EPDM NERO 1000MM	2.000	PZ
Code		Description	Qty	UOM																																														
0H2213A1		LAMIERA IMPIANTO IDRICO CAPPA	1.000	PZ																																														
EL1346A0		CLIP BLOCCA PINZETTA RACCORDI D10 TIERRE	2.000	PZ																																														
EL1440A0		ELETTROVALV OLA H2O AUTOPULENT E BAF EU	2.000	PZ																																														
GN1526A0		O-RING D.INT6,9 SP1.8	5.000	PZ																																														
RC1018A0		FASCETTA ELASTICA D12 ZINCATA	1.000	PZ																																														
RC1019A0		FASCETTA ELASTICA D10 ZINCATA	14.000	PZ																																														
RC1131A0		FASCETTA 200X2,6 BIANC	1.000	PZ																																														
RC1242A0		TERMINALE CHIUSO D10	2.000	PZ																																														
RC1414A1		FASCETTA STRINGITUBO A SCATTO D11,5-12,5	5.000	PZ																																														
TB2821A0		TB2820A-L=40 MM EPDM NER	4.000	PZ																																														
TB2994A0		TB2820A-TUB O EPDM NERO 1000MM	2.000	PZ																																														

COMPONENT			SPARE PART																																																																										
Code	Description	Image	Code	Description	Kit components																																																																								
VL1166A	RACCORDO A L BAM-BB6		KVL1198A	MM EU HOOD CLEANING SYSTEM KIT	<table border="1"> <thead> <tr> <th>Code</th> <th>Description</th> <th>Qty</th> <th>UOM</th> </tr> </thead> <tbody> <tr> <td>TB3252A0</td> <td>TB3132A-L=23 0MM EPDM BIANCO BLU</td> <td>2.000</td> <td>PZ</td> </tr> <tr> <td>TB3614A0</td> <td>TB2820A-L=96 MM NERO EPD</td> <td>1.000</td> <td>PZ</td> </tr> <tr> <td>VI1220A1</td> <td>VITE AUTOFIL. 4.2X11 TCS+ MARUTEX</td> <td>3.000</td> <td>PZ</td> </tr> <tr> <td>VI2070A0</td> <td>VITE AUTOFIL. 40X8 TCB+ SHEETTRACS</td> <td>2.000</td> <td>PZ</td> </tr> <tr> <td>VL1019A0</td> <td>POMPA DETERGENTE VIBRAZIONE</td> <td>1.000</td> <td>PZ</td> </tr> <tr> <td>VL1047A1</td> <td>PORTAGOMM A D6 CODOLO D8</td> <td>2.000</td> <td>PZ</td> </tr> <tr> <td>VL1054B0</td> <td>DISTRIBUTOR E INGRESSI LAVAGGIO ON</td> <td>1.000</td> <td>PZ</td> </tr> <tr> <td>VL1102A1</td> <td>FILTRO IN LINEA DET. + VNR BARBED 6 MM</td> <td>1.000</td> <td>PZ</td> </tr> <tr> <td>VL1127A1</td> <td>RACCORDO A T BARBED 6</td> <td>1.000</td> <td>PZ</td> </tr> <tr> <td>VL1128A1</td> <td>VALVOLA VNR BARBED D6</td> <td>1.000</td> <td>PZ</td> </tr> <tr> <td>VL1165A0</td> <td>RACCORDO DRITTO BAM-BB6</td> <td>1.000</td> <td>PZ</td> </tr> <tr> <td>VL1166A0</td> <td>RACCORDO A L BAM-BB6</td> <td>2.000</td> <td>PZ</td> </tr> <tr> <td>VL1174C0</td> <td>UGELLO CALIBRATO D1.2 MM</td> <td>1.000</td> <td>PZ</td> </tr> <tr> <td>VL1191A0</td> <td>DISTRIBUTOR E USCITA LAVAGGIO ON</td> <td>1.000</td> <td>PZ</td> </tr> <tr> <td>VL1214A0</td> <td>VALVOLA VNR BB6-BAIONET TA</td> <td>1.000</td> <td>PZ</td> </tr> <tr> <td>VM1605A0</td> <td>CLIP TWIST LOCK DIAM. 10,2-12,7 MM</td> <td>2.000</td> <td>PZ</td> </tr> <tr> <td>VM2172A0</td> <td>CLIP BLOCCAGGIO POMPA CON CIRCUITO</td> <td>3.000</td> <td>PZ</td> </tr> </tbody> </table>	Code	Description	Qty	UOM	TB3252A0	TB3132A-L=23 0MM EPDM BIANCO BLU	2.000	PZ	TB3614A0	TB2820A-L=96 MM NERO EPD	1.000	PZ	VI1220A1	VITE AUTOFIL. 4.2X11 TCS+ MARUTEX	3.000	PZ	VI2070A0	VITE AUTOFIL. 40X8 TCB+ SHEETTRACS	2.000	PZ	VL1019A0	POMPA DETERGENTE VIBRAZIONE	1.000	PZ	VL1047A1	PORTAGOMM A D6 CODOLO D8	2.000	PZ	VL1054B0	DISTRIBUTOR E INGRESSI LAVAGGIO ON	1.000	PZ	VL1102A1	FILTRO IN LINEA DET. + VNR BARBED 6 MM	1.000	PZ	VL1127A1	RACCORDO A T BARBED 6	1.000	PZ	VL1128A1	VALVOLA VNR BARBED D6	1.000	PZ	VL1165A0	RACCORDO DRITTO BAM-BB6	1.000	PZ	VL1166A0	RACCORDO A L BAM-BB6	2.000	PZ	VL1174C0	UGELLO CALIBRATO D1.2 MM	1.000	PZ	VL1191A0	DISTRIBUTOR E USCITA LAVAGGIO ON	1.000	PZ	VL1214A0	VALVOLA VNR BB6-BAIONET TA	1.000	PZ	VM1605A0	CLIP TWIST LOCK DIAM. 10,2-12,7 MM	2.000	PZ	VM2172A0	CLIP BLOCCAGGIO POMPA CON CIRCUITO	3.000	PZ
Code	Description	Qty	UOM																																																																										
TB3252A0	TB3132A-L=23 0MM EPDM BIANCO BLU	2.000	PZ																																																																										
TB3614A0	TB2820A-L=96 MM NERO EPD	1.000	PZ																																																																										
VI1220A1	VITE AUTOFIL. 4.2X11 TCS+ MARUTEX	3.000	PZ																																																																										
VI2070A0	VITE AUTOFIL. 40X8 TCB+ SHEETTRACS	2.000	PZ																																																																										
VL1019A0	POMPA DETERGENTE VIBRAZIONE	1.000	PZ																																																																										
VL1047A1	PORTAGOMM A D6 CODOLO D8	2.000	PZ																																																																										
VL1054B0	DISTRIBUTOR E INGRESSI LAVAGGIO ON	1.000	PZ																																																																										
VL1102A1	FILTRO IN LINEA DET. + VNR BARBED 6 MM	1.000	PZ																																																																										
VL1127A1	RACCORDO A T BARBED 6	1.000	PZ																																																																										
VL1128A1	VALVOLA VNR BARBED D6	1.000	PZ																																																																										
VL1165A0	RACCORDO DRITTO BAM-BB6	1.000	PZ																																																																										
VL1166A0	RACCORDO A L BAM-BB6	2.000	PZ																																																																										
VL1174C0	UGELLO CALIBRATO D1.2 MM	1.000	PZ																																																																										
VL1191A0	DISTRIBUTOR E USCITA LAVAGGIO ON	1.000	PZ																																																																										
VL1214A0	VALVOLA VNR BB6-BAIONET TA	1.000	PZ																																																																										
VM1605A0	CLIP TWIST LOCK DIAM. 10,2-12,7 MM	2.000	PZ																																																																										
VM2172A0	CLIP BLOCCAGGIO POMPA CON CIRCUITO	3.000	PZ																																																																										

COMPONENT			SPARE PART																																																																										
Code	Description	Image	Code	Description	Kit components																																																																								
VL1166A	RACCORDO A L BAM-BB6		KVL1187A	3 ROTOR ARMS PLUS EU CLEANING SYSTEM KIT	<table border="1"> <thead> <tr> <th>Code</th> <th>Description</th> <th>Qty</th> <th>UOM</th> </tr> </thead> <tbody> <tr> <td>0H2354A2</td> <td>LAMIERA IMPIANTO LAVAGGIO PLUS XEVC-XEVL</td> <td>1.000</td> <td>PZ</td> </tr> <tr> <td>EL1346A0</td> <td>CLIP BLOCCA PINZETTA RACCORDI D10 TIERRE</td> <td>2.000</td> <td>PZ</td> </tr> <tr> <td>EL1440A0</td> <td>ELETTROVALV OLA H2O AUTOPULENT E BAF EU</td> <td>4.000</td> <td>PZ</td> </tr> <tr> <td>GN1526A0</td> <td>O-RING D.INT6.9 SP1.8</td> <td>9.000</td> <td>PZ</td> </tr> <tr> <td>RC1018A0</td> <td>FASCETTA ELASTICA D12 ZINCATA</td> <td>11.000</td> <td>PZ</td> </tr> <tr> <td>RC1019A0</td> <td>FASCETTA ELASTICA D10 ZINCATA</td> <td>14.000</td> <td>PZ</td> </tr> <tr> <td>RC1130A0</td> <td>FASCETTA 130X2,6</td> <td>1.000</td> <td>PZ</td> </tr> <tr> <td>RC1131A0</td> <td>FASCETTA 200X2,6 BIANC</td> <td>3.000</td> <td>PZ</td> </tr> <tr> <td>RC1242A0</td> <td>TERMINALE CHIUSO D10</td> <td>2.000</td> <td>PZ</td> </tr> <tr> <td>RC1356A0</td> <td>RACCORDO DRITTO FIL. FEMM 8X1/4 BSP</td> <td>1.000</td> <td>PZ</td> </tr> <tr> <td>RC1414A1</td> <td>FASCETTA STRINGITUBO A SCATTO D11.5-12.5</td> <td>1.000</td> <td>PZ</td> </tr> <tr> <td>TB2652A0</td> <td>TB3132A-L750 MM BIANCO BLU EPDM</td> <td>1.000</td> <td>PZ</td> </tr> <tr> <td>TB2677A0</td> <td>TB2820A-TUB O TANICA DET-FDET L1300MM</td> <td>1.000</td> <td>PZ</td> </tr> <tr> <td>TB2821A0</td> <td>TB2820A-L=40 MM EPDM NER</td> <td>4.000</td> <td>PZ</td> </tr> <tr> <td>TB3004A0</td> <td>TB2820A-L=57 0MM EPDM NERO</td> <td>2.000</td> <td>PZ</td> </tr> <tr> <td>TB3024C0</td> <td>TB3132A-TUB O BLU 6X12 L=55MM</td> <td>3.000</td> <td>PZ</td> </tr> <tr> <td>TB3226A0</td> <td>TB2820A-L110 MM COLLEGAMEN TO TANICA-LA</td> <td>1.000</td> <td>PZ</td> </tr> </tbody> </table>	Code	Description	Qty	UOM	0H2354A2	LAMIERA IMPIANTO LAVAGGIO PLUS XEVC-XEVL	1.000	PZ	EL1346A0	CLIP BLOCCA PINZETTA RACCORDI D10 TIERRE	2.000	PZ	EL1440A0	ELETTROVALV OLA H2O AUTOPULENT E BAF EU	4.000	PZ	GN1526A0	O-RING D.INT6.9 SP1.8	9.000	PZ	RC1018A0	FASCETTA ELASTICA D12 ZINCATA	11.000	PZ	RC1019A0	FASCETTA ELASTICA D10 ZINCATA	14.000	PZ	RC1130A0	FASCETTA 130X2,6	1.000	PZ	RC1131A0	FASCETTA 200X2,6 BIANC	3.000	PZ	RC1242A0	TERMINALE CHIUSO D10	2.000	PZ	RC1356A0	RACCORDO DRITTO FIL. FEMM 8X1/4 BSP	1.000	PZ	RC1414A1	FASCETTA STRINGITUBO A SCATTO D11.5-12.5	1.000	PZ	TB2652A0	TB3132A-L750 MM BIANCO BLU EPDM	1.000	PZ	TB2677A0	TB2820A-TUB O TANICA DET-FDET L1300MM	1.000	PZ	TB2821A0	TB2820A-L=40 MM EPDM NER	4.000	PZ	TB3004A0	TB2820A-L=57 0MM EPDM NERO	2.000	PZ	TB3024C0	TB3132A-TUB O BLU 6X12 L=55MM	3.000	PZ	TB3226A0	TB2820A-L110 MM COLLEGAMEN TO TANICA-LA	1.000	PZ
Code	Description	Qty	UOM																																																																										
0H2354A2	LAMIERA IMPIANTO LAVAGGIO PLUS XEVC-XEVL	1.000	PZ																																																																										
EL1346A0	CLIP BLOCCA PINZETTA RACCORDI D10 TIERRE	2.000	PZ																																																																										
EL1440A0	ELETTROVALV OLA H2O AUTOPULENT E BAF EU	4.000	PZ																																																																										
GN1526A0	O-RING D.INT6.9 SP1.8	9.000	PZ																																																																										
RC1018A0	FASCETTA ELASTICA D12 ZINCATA	11.000	PZ																																																																										
RC1019A0	FASCETTA ELASTICA D10 ZINCATA	14.000	PZ																																																																										
RC1130A0	FASCETTA 130X2,6	1.000	PZ																																																																										
RC1131A0	FASCETTA 200X2,6 BIANC	3.000	PZ																																																																										
RC1242A0	TERMINALE CHIUSO D10	2.000	PZ																																																																										
RC1356A0	RACCORDO DRITTO FIL. FEMM 8X1/4 BSP	1.000	PZ																																																																										
RC1414A1	FASCETTA STRINGITUBO A SCATTO D11.5-12.5	1.000	PZ																																																																										
TB2652A0	TB3132A-L750 MM BIANCO BLU EPDM	1.000	PZ																																																																										
TB2677A0	TB2820A-TUB O TANICA DET-FDET L1300MM	1.000	PZ																																																																										
TB2821A0	TB2820A-L=40 MM EPDM NER	4.000	PZ																																																																										
TB3004A0	TB2820A-L=57 0MM EPDM NERO	2.000	PZ																																																																										
TB3024C0	TB3132A-TUB O BLU 6X12 L=55MM	3.000	PZ																																																																										
TB3226A0	TB2820A-L110 MM COLLEGAMEN TO TANICA-LA	1.000	PZ																																																																										

COMPONENT			SPARE PART																																																																											
Code	Description	Image	Code	Description	Kit components																																																																									
VL1166A	RACCORDO A L BAM-BB6		KVL1187A	3 ROTOR ARMS PLUS EU CLEANING SYSTEM KIT	<table border="1"> <thead> <tr> <th>Code</th> <th>Description</th> <th>Qty</th> <th>UOM</th> </tr> </thead> <tbody> <tr> <td>TB3440A0</td> <td>TB3132A-L=10 50MM EPDM BIANCO-BLU</td> <td>1.000</td> <td>PZ</td> </tr> <tr> <td>TB3614A0</td> <td>TB2820A-L=96 MM NERO EPD</td> <td>1.000</td> <td>PZ</td> </tr> <tr> <td>VI1220A1</td> <td>VITE AUTOFIL. 4.2X11 TCS+ MARUTEX</td> <td>1.000</td> <td>PZ</td> </tr> <tr> <td>VL1019A0</td> <td>POMPA DETERGENTE VIBRAZIONE</td> <td>1.000</td> <td>PZ</td> </tr> <tr> <td>VL1047A1</td> <td>PORTAGOMM A D6 CODOLO D8</td> <td>1.000</td> <td>PZ</td> </tr> <tr> <td>VL1102A1</td> <td>FILTRO IN LINEA DET. + VNR BARBED 6 MM</td> <td>1.000</td> <td>PZ</td> </tr> <tr> <td>VL1127A1</td> <td>RACCORDO A T BARBED 6</td> <td>2.000</td> <td>PZ</td> </tr> <tr> <td>VL1128A1</td> <td>VALVOLA VNR BARBED D6</td> <td>2.000</td> <td>PZ</td> </tr> <tr> <td>VL1166A0</td> <td>RACCORDO A L BAM-BB6</td> <td>4.000</td> <td>PZ</td> </tr> <tr> <td>VL1167A2</td> <td>FLOW RESTRICTOR 3 GIRANTI GN21 B-B</td> <td>1.000</td> <td>PZ</td> </tr> <tr> <td>VL1174C0</td> <td>UGELLO CALIBRATO D1.2 MM</td> <td>1.000</td> <td>PZ</td> </tr> <tr> <td>VL1186A0</td> <td>DISTRIBUTOR E LAVAGGIO PLUS 3 VIE UGELLO</td> <td>1.000</td> <td>PZ</td> </tr> <tr> <td>VL1190A0</td> <td>DISTRIBUTOR E INGRESSI LAVAGGIO PLUS</td> <td>1.000</td> <td>PZ</td> </tr> <tr> <td>VL1214A0</td> <td>VALVOLA VNR BB6-BAIONET TA</td> <td>1.000</td> <td>PZ</td> </tr> <tr> <td>VL1398A0</td> <td>PRESSOSTAT O.N.O. 1/4 M CI</td> <td>1.000</td> <td>PZ</td> </tr> <tr> <td>VM1605A0</td> <td>CLIP TWIST LOCK DIAM. 10,2-12,7 MM</td> <td>3.000</td> <td>PZ</td> </tr> <tr> <td>VM2172A0</td> <td>CLIP BLOCCAGGIO POMPA CON CIRCUITO</td> <td>5.000</td> <td>PZ</td> </tr> </tbody> </table>		Code	Description	Qty	UOM	TB3440A0	TB3132A-L=10 50MM EPDM BIANCO-BLU	1.000	PZ	TB3614A0	TB2820A-L=96 MM NERO EPD	1.000	PZ	VI1220A1	VITE AUTOFIL. 4.2X11 TCS+ MARUTEX	1.000	PZ	VL1019A0	POMPA DETERGENTE VIBRAZIONE	1.000	PZ	VL1047A1	PORTAGOMM A D6 CODOLO D8	1.000	PZ	VL1102A1	FILTRO IN LINEA DET. + VNR BARBED 6 MM	1.000	PZ	VL1127A1	RACCORDO A T BARBED 6	2.000	PZ	VL1128A1	VALVOLA VNR BARBED D6	2.000	PZ	VL1166A0	RACCORDO A L BAM-BB6	4.000	PZ	VL1167A2	FLOW RESTRICTOR 3 GIRANTI GN21 B-B	1.000	PZ	VL1174C0	UGELLO CALIBRATO D1.2 MM	1.000	PZ	VL1186A0	DISTRIBUTOR E LAVAGGIO PLUS 3 VIE UGELLO	1.000	PZ	VL1190A0	DISTRIBUTOR E INGRESSI LAVAGGIO PLUS	1.000	PZ	VL1214A0	VALVOLA VNR BB6-BAIONET TA	1.000	PZ	VL1398A0	PRESSOSTAT O.N.O. 1/4 M CI	1.000	PZ	VM1605A0	CLIP TWIST LOCK DIAM. 10,2-12,7 MM	3.000	PZ	VM2172A0	CLIP BLOCCAGGIO POMPA CON CIRCUITO	5.000	PZ
Code	Description	Qty	UOM																																																																											
TB3440A0	TB3132A-L=10 50MM EPDM BIANCO-BLU	1.000	PZ																																																																											
TB3614A0	TB2820A-L=96 MM NERO EPD	1.000	PZ																																																																											
VI1220A1	VITE AUTOFIL. 4.2X11 TCS+ MARUTEX	1.000	PZ																																																																											
VL1019A0	POMPA DETERGENTE VIBRAZIONE	1.000	PZ																																																																											
VL1047A1	PORTAGOMM A D6 CODOLO D8	1.000	PZ																																																																											
VL1102A1	FILTRO IN LINEA DET. + VNR BARBED 6 MM	1.000	PZ																																																																											
VL1127A1	RACCORDO A T BARBED 6	2.000	PZ																																																																											
VL1128A1	VALVOLA VNR BARBED D6	2.000	PZ																																																																											
VL1166A0	RACCORDO A L BAM-BB6	4.000	PZ																																																																											
VL1167A2	FLOW RESTRICTOR 3 GIRANTI GN21 B-B	1.000	PZ																																																																											
VL1174C0	UGELLO CALIBRATO D1.2 MM	1.000	PZ																																																																											
VL1186A0	DISTRIBUTOR E LAVAGGIO PLUS 3 VIE UGELLO	1.000	PZ																																																																											
VL1190A0	DISTRIBUTOR E INGRESSI LAVAGGIO PLUS	1.000	PZ																																																																											
VL1214A0	VALVOLA VNR BB6-BAIONET TA	1.000	PZ																																																																											
VL1398A0	PRESSOSTAT O.N.O. 1/4 M CI	1.000	PZ																																																																											
VM1605A0	CLIP TWIST LOCK DIAM. 10,2-12,7 MM	3.000	PZ																																																																											
VM2172A0	CLIP BLOCCAGGIO POMPA CON CIRCUITO	5.000	PZ																																																																											

COMPONENT			SPARE PART																																																																														
Code	Description	Image	Code	Description	Kit components																																																																												
VL1166A	RACCORDO A L BAM-BB6		KVL1184A	2 ROTOR ARMS PLUS EU CLEANING SYSTEM KIT	<table border="1"> <thead> <tr> <th>Code</th> <th>Description</th> <th>Qty</th> <th>UOM</th> </tr> </thead> <tbody> <tr> <td>0H2354A2</td> <td>LAMIERA IMPIANTO LAVAGGIO PLUS XEVC-XEVL</td> <td>1.000</td> <td>PZ</td> </tr> <tr> <td>EL1346A0</td> <td>CLIP BLOCCA PINZETTA RACCORDI D10 TIERRE</td> <td>2.000</td> <td>PZ</td> </tr> <tr> <td>EL1440A0</td> <td>ELETTROVALV OLA H2O AUTOPULENT E BAF EU</td> <td>4.000</td> <td>PZ</td> </tr> <tr> <td>GN1526A0</td> <td>O-RING D.INT6.9 SP1.8</td> <td>9.000</td> <td>PZ</td> </tr> <tr> <td>RC1018A0</td> <td>FASCETTA ELASTICA D12 ZINCATA</td> <td>2.000</td> <td>PZ</td> </tr> <tr> <td>RC1019A0</td> <td>FASCETTA ELASTICA D10 ZINCATA</td> <td>13.000</td> <td>PZ</td> </tr> <tr> <td>RC1130A0</td> <td>FASCETTA 130X2,6</td> <td>1.000</td> <td>PZ</td> </tr> <tr> <td>RC1131A0</td> <td>FASCETTA 200X2,6 BIANC</td> <td>3.000</td> <td>PZ</td> </tr> <tr> <td>RC1242A0</td> <td>TERMINALE CHIUSO D10</td> <td>2.000</td> <td>PZ</td> </tr> <tr> <td>RC1356A0</td> <td>RACCORDO DRITTO FIL. FEMM 8X1/4 BSP</td> <td>1.000</td> <td>PZ</td> </tr> <tr> <td>RC1414A1</td> <td>FASCETTA STRINGITUBO A SCATTO D11.5-12.5</td> <td>1.000</td> <td>PZ</td> </tr> <tr> <td>TB2821A0</td> <td>TB2820A-L=40 MM EPDM NER</td> <td>4.000</td> <td>PZ</td> </tr> <tr> <td>TB2994A0</td> <td>TB2820A-TUB O EPDM NERO 1000MM</td> <td>1.000</td> <td>PZ</td> </tr> <tr> <td>TB3004A0</td> <td>TB2820A-L=57 0MM EPDM NERO</td> <td>2.000</td> <td>PZ</td> </tr> <tr> <td>TB3005B0</td> <td>TB3132A-L=55 0MM EPDM BIANCO BLU</td> <td>1.000</td> <td>PZ</td> </tr> <tr> <td>TB3440A0</td> <td>TB3132A-L=10 50MM EPDM BIANCO-BLU</td> <td>1.000</td> <td>PZ</td> </tr> <tr> <td>TB3614A0</td> <td>TB2820A-L=96 MM NERO EPD</td> <td>1.000</td> <td>PZ</td> </tr> <tr> <td>VI1220A1</td> <td>VITE AUTOFIL. 4.2X11 TCS+ MARUTEX</td> <td>1.000</td> <td>PZ</td> </tr> </tbody> </table>	Code	Description	Qty	UOM	0H2354A2	LAMIERA IMPIANTO LAVAGGIO PLUS XEVC-XEVL	1.000	PZ	EL1346A0	CLIP BLOCCA PINZETTA RACCORDI D10 TIERRE	2.000	PZ	EL1440A0	ELETTROVALV OLA H2O AUTOPULENT E BAF EU	4.000	PZ	GN1526A0	O-RING D.INT6.9 SP1.8	9.000	PZ	RC1018A0	FASCETTA ELASTICA D12 ZINCATA	2.000	PZ	RC1019A0	FASCETTA ELASTICA D10 ZINCATA	13.000	PZ	RC1130A0	FASCETTA 130X2,6	1.000	PZ	RC1131A0	FASCETTA 200X2,6 BIANC	3.000	PZ	RC1242A0	TERMINALE CHIUSO D10	2.000	PZ	RC1356A0	RACCORDO DRITTO FIL. FEMM 8X1/4 BSP	1.000	PZ	RC1414A1	FASCETTA STRINGITUBO A SCATTO D11.5-12.5	1.000	PZ	TB2821A0	TB2820A-L=40 MM EPDM NER	4.000	PZ	TB2994A0	TB2820A-TUB O EPDM NERO 1000MM	1.000	PZ	TB3004A0	TB2820A-L=57 0MM EPDM NERO	2.000	PZ	TB3005B0	TB3132A-L=55 0MM EPDM BIANCO BLU	1.000	PZ	TB3440A0	TB3132A-L=10 50MM EPDM BIANCO-BLU	1.000	PZ	TB3614A0	TB2820A-L=96 MM NERO EPD	1.000	PZ	VI1220A1	VITE AUTOFIL. 4.2X11 TCS+ MARUTEX	1.000	PZ
Code	Description	Qty	UOM																																																																														
0H2354A2	LAMIERA IMPIANTO LAVAGGIO PLUS XEVC-XEVL	1.000	PZ																																																																														
EL1346A0	CLIP BLOCCA PINZETTA RACCORDI D10 TIERRE	2.000	PZ																																																																														
EL1440A0	ELETTROVALV OLA H2O AUTOPULENT E BAF EU	4.000	PZ																																																																														
GN1526A0	O-RING D.INT6.9 SP1.8	9.000	PZ																																																																														
RC1018A0	FASCETTA ELASTICA D12 ZINCATA	2.000	PZ																																																																														
RC1019A0	FASCETTA ELASTICA D10 ZINCATA	13.000	PZ																																																																														
RC1130A0	FASCETTA 130X2,6	1.000	PZ																																																																														
RC1131A0	FASCETTA 200X2,6 BIANC	3.000	PZ																																																																														
RC1242A0	TERMINALE CHIUSO D10	2.000	PZ																																																																														
RC1356A0	RACCORDO DRITTO FIL. FEMM 8X1/4 BSP	1.000	PZ																																																																														
RC1414A1	FASCETTA STRINGITUBO A SCATTO D11.5-12.5	1.000	PZ																																																																														
TB2821A0	TB2820A-L=40 MM EPDM NER	4.000	PZ																																																																														
TB2994A0	TB2820A-TUB O EPDM NERO 1000MM	1.000	PZ																																																																														
TB3004A0	TB2820A-L=57 0MM EPDM NERO	2.000	PZ																																																																														
TB3005B0	TB3132A-L=55 0MM EPDM BIANCO BLU	1.000	PZ																																																																														
TB3440A0	TB3132A-L=10 50MM EPDM BIANCO-BLU	1.000	PZ																																																																														
TB3614A0	TB2820A-L=96 MM NERO EPD	1.000	PZ																																																																														
VI1220A1	VITE AUTOFIL. 4.2X11 TCS+ MARUTEX	1.000	PZ																																																																														





COMPONENT			SPARE PART																																																																													
Code	Description	Image	Code	Description	Kit components																																																																											
VL1166A	RACCORDO A L BAM-BB6		KVL1184A	2 ROTOR ARMS PLUS EU CLEANING SYSTEM KIT	<table border="1"> <thead> <tr> <th>Code</th> <th>Description</th> <th>Qty</th> <th>UOM</th> </tr> </thead> <tbody> <tr> <td>VL1019A0</td> <td>POMPA DETERGENTE VIBRAZIONE</td> <td>1.000</td> <td>PZ</td> </tr> <tr> <td>VL1047A1</td> <td>PORTAGOMM A D6 CODOLO D8</td> <td>1.000</td> <td>PZ</td> </tr> <tr> <td>VL1102A1</td> <td>FILTRO IN LINEA DET. + VNR BARBED 6 MM</td> <td>1.000</td> <td>PZ</td> </tr> <tr> <td>VL1128A1</td> <td>VALVOLA VNR BARBED D6</td> <td>1.000</td> <td>PZ</td> </tr> <tr> <td>VL1166A0</td> <td>RACCORDO A L BAM-BB6</td> <td>4.000</td> <td>PZ</td> </tr> <tr> <td>VL1174C0</td> <td>UGELLO CALIBRATO D1.2 MM</td> <td>1.000</td> <td>PZ</td> </tr> <tr> <td>VL1186A0</td> <td>DISTRIBUTOR E LAVAGGIO PLUS 3 VIE UGELLO</td> <td>1.000</td> <td>PZ</td> </tr> <tr> <td>VL1190A0</td> <td>DISTRIBUTOR E INGRESSI LAVAGGIO PLUS</td> <td>1.000</td> <td>PZ</td> </tr> <tr> <td>VL1214A0</td> <td>VALVOLA VNR BB6-BAIONET TA</td> <td>1.000</td> <td>PZ</td> </tr> <tr> <td>VL1398A0</td> <td>PRESSOSTAT O.N.O. 1/4 M CI</td> <td>1.000</td> <td>PZ</td> </tr> <tr> <td>VM1605A0</td> <td>CLIP TWIST LOCK DIAM. 10.2-12.7 MM</td> <td>3.000</td> <td>PZ</td> </tr> <tr> <td>VM2172A0</td> <td>CLIP BLOCCAGGIO POMPA CON CIRCUITO</td> <td>5.000</td> <td>PZ</td> </tr> </tbody> </table>	Code	Description	Qty	UOM	VL1019A0	POMPA DETERGENTE VIBRAZIONE	1.000	PZ	VL1047A1	PORTAGOMM A D6 CODOLO D8	1.000	PZ	VL1102A1	FILTRO IN LINEA DET. + VNR BARBED 6 MM	1.000	PZ	VL1128A1	VALVOLA VNR BARBED D6	1.000	PZ	VL1166A0	RACCORDO A L BAM-BB6	4.000	PZ	VL1174C0	UGELLO CALIBRATO D1.2 MM	1.000	PZ	VL1186A0	DISTRIBUTOR E LAVAGGIO PLUS 3 VIE UGELLO	1.000	PZ	VL1190A0	DISTRIBUTOR E INGRESSI LAVAGGIO PLUS	1.000	PZ	VL1214A0	VALVOLA VNR BB6-BAIONET TA	1.000	PZ	VL1398A0	PRESSOSTAT O.N.O. 1/4 M CI	1.000	PZ	VM1605A0	CLIP TWIST LOCK DIAM. 10.2-12.7 MM	3.000	PZ	VM2172A0	CLIP BLOCCAGGIO POMPA CON CIRCUITO	5.000	PZ	KVL1183A	1 ROTOR ARM PLUS CLEANING SYSTEM KIT	<table border="1"> <thead> <tr> <th>Code</th> <th>Description</th> <th>Qty</th> <th>UOM</th> </tr> </thead> <tbody> <tr> <td>0H2354A2</td> <td>LAMIERA IMPIANTO LAVAGGIO PLUS XEVC-XEVL</td> <td>1.000</td> <td>PZ</td> </tr> <tr> <td>EL1346A0</td> <td>CLIP BLOCCA PINZETTA RACCORDI D10 TIERRE</td> <td>2.000</td> <td>PZ</td> </tr> <tr> <td>EL1440A0</td> <td>ELETTROVALV OLA H2O AUTOPULENT E BAF EU</td> <td>3.000</td> <td>PZ</td> </tr> <tr> <td>GN1526A0</td> <td>O-RING D.INT6.9 SP1.8</td> <td>7.000</td> <td>PZ</td> </tr> </tbody> </table>	Code	Description	Qty	UOM	0H2354A2	LAMIERA IMPIANTO LAVAGGIO PLUS XEVC-XEVL	1.000	PZ	EL1346A0	CLIP BLOCCA PINZETTA RACCORDI D10 TIERRE	2.000	PZ	EL1440A0	ELETTROVALV OLA H2O AUTOPULENT E BAF EU	3.000	PZ	GN1526A0	O-RING D.INT6.9 SP1.8	7.000	PZ
			Code	Description	Qty	UOM																																																																										
VL1019A0	POMPA DETERGENTE VIBRAZIONE	1.000	PZ																																																																													
VL1047A1	PORTAGOMM A D6 CODOLO D8	1.000	PZ																																																																													
VL1102A1	FILTRO IN LINEA DET. + VNR BARBED 6 MM	1.000	PZ																																																																													
VL1128A1	VALVOLA VNR BARBED D6	1.000	PZ																																																																													
VL1166A0	RACCORDO A L BAM-BB6	4.000	PZ																																																																													
VL1174C0	UGELLO CALIBRATO D1.2 MM	1.000	PZ																																																																													
VL1186A0	DISTRIBUTOR E LAVAGGIO PLUS 3 VIE UGELLO	1.000	PZ																																																																													
VL1190A0	DISTRIBUTOR E INGRESSI LAVAGGIO PLUS	1.000	PZ																																																																													
VL1214A0	VALVOLA VNR BB6-BAIONET TA	1.000	PZ																																																																													
VL1398A0	PRESSOSTAT O.N.O. 1/4 M CI	1.000	PZ																																																																													
VM1605A0	CLIP TWIST LOCK DIAM. 10.2-12.7 MM	3.000	PZ																																																																													
VM2172A0	CLIP BLOCCAGGIO POMPA CON CIRCUITO	5.000	PZ																																																																													
Code	Description	Qty	UOM																																																																													
0H2354A2	LAMIERA IMPIANTO LAVAGGIO PLUS XEVC-XEVL	1.000	PZ																																																																													
EL1346A0	CLIP BLOCCA PINZETTA RACCORDI D10 TIERRE	2.000	PZ																																																																													
EL1440A0	ELETTROVALV OLA H2O AUTOPULENT E BAF EU	3.000	PZ																																																																													
GN1526A0	O-RING D.INT6.9 SP1.8	7.000	PZ																																																																													

COMPONENT			SPARE PART																																																																														
Code	Description	Image	Code	Description	Kit components																																																																												
VL1166A	RACCORDO A L BAM-BB6		KVL1183A	1 ROTOR ARM PLUS CLEANING SYSTEM KIT	<table border="1"> <thead> <tr> <th>Code</th> <th>Description</th> <th>Qty</th> <th>UOM</th> </tr> </thead> <tbody> <tr> <td>RC1018A0</td> <td>FASCETTA ELASTICA D12 ZINCATA</td> <td>1.000</td> <td>PZ</td> </tr> <tr> <td>RC1019A0</td> <td>FASCETTA ELASTICA D10 ZINCATA</td> <td>12.000</td> <td>PZ</td> </tr> <tr> <td>RC1130A0</td> <td>FASCETTA 130X2,6</td> <td>1.000</td> <td>PZ</td> </tr> <tr> <td>RC1131A0</td> <td>FASCETTA 200X2,6 BIANC</td> <td>2.000</td> <td>PZ</td> </tr> <tr> <td>RC1242A0</td> <td>TERMINALE CHIUSO D10</td> <td>2.000</td> <td>PZ</td> </tr> <tr> <td>RC1356A0</td> <td>RACCORDO DRITTO FIL. FEMM 8X1/4 BSP</td> <td>1.000</td> <td>PZ</td> </tr> <tr> <td>RC1414A1</td> <td>FASCETTA STRINGITUBO A SCATTO D11.5-12.5</td> <td>4.000</td> <td>PZ</td> </tr> <tr> <td>TB2821A0</td> <td>TB2820A-L=40 MM EPDM NER</td> <td>4.000</td> <td>PZ</td> </tr> <tr> <td>TB3004A0</td> <td>TB2820A-L=57 0MM EPDM NERO</td> <td>1.000</td> <td>PZ</td> </tr> <tr> <td>TB3252A0</td> <td>TB3132A-L=23 0MM EPDM BIANCO BLU</td> <td>1.000</td> <td>PZ</td> </tr> <tr> <td>TB3614A0</td> <td>TB2820A-L=96 MM NERO EPD</td> <td>1.000</td> <td>PZ</td> </tr> <tr> <td>TB5360A0</td> <td>TB3132A-TUB O EPDM TELATO BIANCO-BLU 550M</td> <td>1.000</td> <td>PZ</td> </tr> <tr> <td>TB5362A0</td> <td>TB3132A-TUB O EPDM TELATO BIANCO-BLU 230M</td> <td>1.000</td> <td>PZ</td> </tr> <tr> <td>VH1220A1</td> <td>VITE AUTOFIL. 4.2X11 TCS+ MARUTEX</td> <td>1.000</td> <td>PZ</td> </tr> <tr> <td>VL1019A0</td> <td>POMPA DETERGENTE VIBRAZIONE</td> <td>1.000</td> <td>PZ</td> </tr> <tr> <td>VL1047A1</td> <td>PORTAGOMM A D6 CODOLO D8</td> <td>1.000</td> <td>PZ</td> </tr> <tr> <td>VL1102A1</td> <td>FILTRO IN LINEA DET. + VNR BARBED 6 MM</td> <td>1.000</td> <td>PZ</td> </tr> <tr> <td>VL1128A1</td> <td>VALVOLA VNR BARBED D6</td> <td>1.000</td> <td>PZ</td> </tr> </tbody> </table>	Code	Description	Qty	UOM	RC1018A0	FASCETTA ELASTICA D12 ZINCATA	1.000	PZ	RC1019A0	FASCETTA ELASTICA D10 ZINCATA	12.000	PZ	RC1130A0	FASCETTA 130X2,6	1.000	PZ	RC1131A0	FASCETTA 200X2,6 BIANC	2.000	PZ	RC1242A0	TERMINALE CHIUSO D10	2.000	PZ	RC1356A0	RACCORDO DRITTO FIL. FEMM 8X1/4 BSP	1.000	PZ	RC1414A1	FASCETTA STRINGITUBO A SCATTO D11.5-12.5	4.000	PZ	TB2821A0	TB2820A-L=40 MM EPDM NER	4.000	PZ	TB3004A0	TB2820A-L=57 0MM EPDM NERO	1.000	PZ	TB3252A0	TB3132A-L=23 0MM EPDM BIANCO BLU	1.000	PZ	TB3614A0	TB2820A-L=96 MM NERO EPD	1.000	PZ	TB5360A0	TB3132A-TUB O EPDM TELATO BIANCO-BLU 550M	1.000	PZ	TB5362A0	TB3132A-TUB O EPDM TELATO BIANCO-BLU 230M	1.000	PZ	VH1220A1	VITE AUTOFIL. 4.2X11 TCS+ MARUTEX	1.000	PZ	VL1019A0	POMPA DETERGENTE VIBRAZIONE	1.000	PZ	VL1047A1	PORTAGOMM A D6 CODOLO D8	1.000	PZ	VL1102A1	FILTRO IN LINEA DET. + VNR BARBED 6 MM	1.000	PZ	VL1128A1	VALVOLA VNR BARBED D6	1.000	PZ
Code	Description	Qty	UOM																																																																														
RC1018A0	FASCETTA ELASTICA D12 ZINCATA	1.000	PZ																																																																														
RC1019A0	FASCETTA ELASTICA D10 ZINCATA	12.000	PZ																																																																														
RC1130A0	FASCETTA 130X2,6	1.000	PZ																																																																														
RC1131A0	FASCETTA 200X2,6 BIANC	2.000	PZ																																																																														
RC1242A0	TERMINALE CHIUSO D10	2.000	PZ																																																																														
RC1356A0	RACCORDO DRITTO FIL. FEMM 8X1/4 BSP	1.000	PZ																																																																														
RC1414A1	FASCETTA STRINGITUBO A SCATTO D11.5-12.5	4.000	PZ																																																																														
TB2821A0	TB2820A-L=40 MM EPDM NER	4.000	PZ																																																																														
TB3004A0	TB2820A-L=57 0MM EPDM NERO	1.000	PZ																																																																														
TB3252A0	TB3132A-L=23 0MM EPDM BIANCO BLU	1.000	PZ																																																																														
TB3614A0	TB2820A-L=96 MM NERO EPD	1.000	PZ																																																																														
TB5360A0	TB3132A-TUB O EPDM TELATO BIANCO-BLU 550M	1.000	PZ																																																																														
TB5362A0	TB3132A-TUB O EPDM TELATO BIANCO-BLU 230M	1.000	PZ																																																																														
VH1220A1	VITE AUTOFIL. 4.2X11 TCS+ MARUTEX	1.000	PZ																																																																														
VL1019A0	POMPA DETERGENTE VIBRAZIONE	1.000	PZ																																																																														
VL1047A1	PORTAGOMM A D6 CODOLO D8	1.000	PZ																																																																														
VL1102A1	FILTRO IN LINEA DET. + VNR BARBED 6 MM	1.000	PZ																																																																														
VL1128A1	VALVOLA VNR BARBED D6	1.000	PZ																																																																														

COMPONENT			SPARE PART																																							
Code	Description	Image	Code	Description	Kit components																																					
VL1166A	RACCORDO A L BAM-BB6		KVL1183A	1 ROTOR ARM PLUS CLEANING SYSTEM KIT	<table border="1"> <thead> <tr> <th>Code</th> <th>Description</th> <th>Qty</th> <th>UOM</th> </tr> </thead> <tbody> <tr> <td>VL1166A0</td> <td>RACCORDO A L BAM-BB6</td> <td>3.000</td> <td>PZ</td> </tr> <tr> <td>VL1174C0</td> <td>UGELLO CALIBRATO D1.2 MM</td> <td>1.000</td> <td>PZ</td> </tr> <tr> <td>VL1185A0</td> <td>DISTRIBUTOR E LAVAGGIO PLUS 2 VIE UGELLO</td> <td>1.000</td> <td>PZ</td> </tr> <tr> <td>VL1190A0</td> <td>DISTRIBUTOR E INGRESSI LAVAGGIO PLUS</td> <td>1.000</td> <td>PZ</td> </tr> <tr> <td>VL1214A0</td> <td>VALVOLA VNR BB6-BAIONET TA</td> <td>1.000</td> <td>PZ</td> </tr> <tr> <td>VL1398A0</td> <td>PRESSOSTAT O.N.O. 1/4 M.CI</td> <td>1.000</td> <td>PZ</td> </tr> <tr> <td>VM1605A0</td> <td>CLIP TWIST LOCK DIAM. 10,2-12,7 MM</td> <td>3.000</td> <td>PZ</td> </tr> <tr> <td>VM2172A0</td> <td>CLIP BLOCCAGGIO POMPA CON CIRCUITO</td> <td>4.000</td> <td>PZ</td> </tr> </tbody> </table>	Code	Description	Qty	UOM	VL1166A0	RACCORDO A L BAM-BB6	3.000	PZ	VL1174C0	UGELLO CALIBRATO D1.2 MM	1.000	PZ	VL1185A0	DISTRIBUTOR E LAVAGGIO PLUS 2 VIE UGELLO	1.000	PZ	VL1190A0	DISTRIBUTOR E INGRESSI LAVAGGIO PLUS	1.000	PZ	VL1214A0	VALVOLA VNR BB6-BAIONET TA	1.000	PZ	VL1398A0	PRESSOSTAT O.N.O. 1/4 M.CI	1.000	PZ	VM1605A0	CLIP TWIST LOCK DIAM. 10,2-12,7 MM	3.000	PZ	VM2172A0	CLIP BLOCCAGGIO POMPA CON CIRCUITO	4.000	PZ	
			Code	Description	Qty	UOM																																				
VL1166A0	RACCORDO A L BAM-BB6	3.000	PZ																																							
VL1174C0	UGELLO CALIBRATO D1.2 MM	1.000	PZ																																							
VL1185A0	DISTRIBUTOR E LAVAGGIO PLUS 2 VIE UGELLO	1.000	PZ																																							
VL1190A0	DISTRIBUTOR E INGRESSI LAVAGGIO PLUS	1.000	PZ																																							
VL1214A0	VALVOLA VNR BB6-BAIONET TA	1.000	PZ																																							
VL1398A0	PRESSOSTAT O.N.O. 1/4 M.CI	1.000	PZ																																							
VM1605A0	CLIP TWIST LOCK DIAM. 10,2-12,7 MM	3.000	PZ																																							
VM2172A0	CLIP BLOCCAGGIO POMPA CON CIRCUITO	4.000	PZ																																							
KVL1182A	ONE 1ROT CLEANING SYSTEM KIT (0311 EXC.)	<table border="1"> <thead> <tr> <th>Code</th> <th>Description</th> <th>Qty</th> <th>UOM</th> </tr> </thead> <tbody> <tr> <td>0H2202A1</td> <td>STAFFA LAVAGGIO ONE CON ELV STEAM</td> <td>1.000</td> <td>PZ</td> </tr> <tr> <td>EL1346A0</td> <td>CLIP BLOCCA PINZETTA RACCORDI D10 TIERRE</td> <td>2.000</td> <td>PZ</td> </tr> <tr> <td>EL1440A0</td> <td>ELETTROVALV OLA H2O AUTOPULENT E BAF EU</td> <td>1.000</td> <td>PZ</td> </tr> <tr> <td>GN1526A0</td> <td>O-RING D.INT6.9 SP1.8</td> <td>3.000</td> <td>PZ</td> </tr> <tr> <td>RC1019A0</td> <td>FASCETTA ELASTICA D10 ZINCATA</td> <td>12.000</td> <td>PZ</td> </tr> <tr> <td>RC1242A0</td> <td>TERMINALE CHIUSO D10</td> <td>2.000</td> <td>PZ</td> </tr> <tr> <td>RC1414A1</td> <td>FASCETTA STRINGITUBO A SCATTO D11,5-12,5</td> <td>4.000</td> <td>PZ</td> </tr> <tr> <td>TB2821A0</td> <td>TB2820A-L=40 MM EPDM NER</td> <td>4.000</td> <td>PZ</td> </tr> <tr> <td>TB3004A0</td> <td>TB2820A-L=57 0MM EPDM NERO</td> <td>1.000</td> <td>PZ</td> </tr> </tbody> </table>	Code	Description	Qty	UOM	0H2202A1	STAFFA LAVAGGIO ONE CON ELV STEAM	1.000	PZ	EL1346A0	CLIP BLOCCA PINZETTA RACCORDI D10 TIERRE	2.000	PZ	EL1440A0	ELETTROVALV OLA H2O AUTOPULENT E BAF EU	1.000	PZ	GN1526A0	O-RING D.INT6.9 SP1.8	3.000	PZ	RC1019A0	FASCETTA ELASTICA D10 ZINCATA	12.000	PZ	RC1242A0	TERMINALE CHIUSO D10	2.000	PZ	RC1414A1	FASCETTA STRINGITUBO A SCATTO D11,5-12,5	4.000	PZ	TB2821A0	TB2820A-L=40 MM EPDM NER	4.000	PZ	TB3004A0	TB2820A-L=57 0MM EPDM NERO	1.000	PZ
Code	Description	Qty	UOM																																							
0H2202A1	STAFFA LAVAGGIO ONE CON ELV STEAM	1.000	PZ																																							
EL1346A0	CLIP BLOCCA PINZETTA RACCORDI D10 TIERRE	2.000	PZ																																							
EL1440A0	ELETTROVALV OLA H2O AUTOPULENT E BAF EU	1.000	PZ																																							
GN1526A0	O-RING D.INT6.9 SP1.8	3.000	PZ																																							
RC1019A0	FASCETTA ELASTICA D10 ZINCATA	12.000	PZ																																							
RC1242A0	TERMINALE CHIUSO D10	2.000	PZ																																							
RC1414A1	FASCETTA STRINGITUBO A SCATTO D11,5-12,5	4.000	PZ																																							
TB2821A0	TB2820A-L=40 MM EPDM NER	4.000	PZ																																							
TB3004A0	TB2820A-L=57 0MM EPDM NERO	1.000	PZ																																							

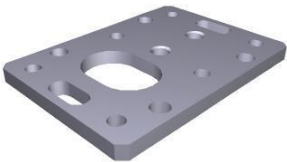
COMPONENT			SPARE PART																																																																									
Code	Description	Image	Code	Description	Kit components																																																																							
VL1166A	RACCORDO A L BAM-BB6		KVL1182A	ONE 1ROT CLEANING SYSTEM KIT (0311 EXC.)	<table border="1"> <thead> <tr> <th>Code</th> <th>Description</th> <th>Qty</th> <th>UOM</th> </tr> </thead> <tbody> <tr> <td>TB3225B0</td> <td>TB2820A-TUB O EPDM NERO 670MM</td> <td>1.000</td> <td>PZ</td> </tr> <tr> <td>TB3614A0</td> <td>TB2820A-L=96 MM NERO EPD</td> <td>1.000</td> <td>PZ</td> </tr> <tr> <td>TB5361A0</td> <td>TB3132A-TUB O EPDM TELAIO BIANCO-BLU 670M</td> <td>1.000</td> <td>PZ</td> </tr> <tr> <td>VI1220A1</td> <td>VITE AUTOFIL. 4.2X11 TCS+ MARUTEX</td> <td>2.000</td> <td>PZ</td> </tr> <tr> <td>VL1019A0</td> <td>POMPA DETERGENTE VIBRAZIONE</td> <td>1.000</td> <td>PZ</td> </tr> <tr> <td>VL1047A1</td> <td>PORTAGOMM A D6 CODOLO D8</td> <td>1.000</td> <td>PZ</td> </tr> <tr> <td>VL1054B0</td> <td>DISTRIBUTOR E INGRESSI LAVAGGIO ON</td> <td>1.000</td> <td>PZ</td> </tr> <tr> <td>VL1102A1</td> <td>FILTRO IN LINEA DET. + VNR BARBED 6 MM</td> <td>1.000</td> <td>PZ</td> </tr> <tr> <td>VL1128A1</td> <td>VALVOLA VNR BARBED D6</td> <td>1.000</td> <td>PZ</td> </tr> <tr> <td>VL1166A0</td> <td>RACCORDO A L BAM-BB6</td> <td>1.000</td> <td>PZ</td> </tr> <tr> <td>VL1174C0</td> <td>UGELLO CALIBRATO D1.2 MM</td> <td>1.000</td> <td>PZ</td> </tr> <tr> <td>VL1191A0</td> <td>DISTRIBUTOR E USCITA LAVAGGIO ON</td> <td>1.000</td> <td>PZ</td> </tr> <tr> <td>VL1214A0</td> <td>VALVOLA VNR BB6-BAIONET TA</td> <td>1.000</td> <td>PZ</td> </tr> <tr> <td>VM2172A0</td> <td>CLIP BLOCCAGGIO POMPA CON CIRCUITO</td> <td>2.000</td> <td>PZ</td> </tr> </tbody> </table>	Code	Description	Qty	UOM	TB3225B0	TB2820A-TUB O EPDM NERO 670MM	1.000	PZ	TB3614A0	TB2820A-L=96 MM NERO EPD	1.000	PZ	TB5361A0	TB3132A-TUB O EPDM TELAIO BIANCO-BLU 670M	1.000	PZ	VI1220A1	VITE AUTOFIL. 4.2X11 TCS+ MARUTEX	2.000	PZ	VL1019A0	POMPA DETERGENTE VIBRAZIONE	1.000	PZ	VL1047A1	PORTAGOMM A D6 CODOLO D8	1.000	PZ	VL1054B0	DISTRIBUTOR E INGRESSI LAVAGGIO ON	1.000	PZ	VL1102A1	FILTRO IN LINEA DET. + VNR BARBED 6 MM	1.000	PZ	VL1128A1	VALVOLA VNR BARBED D6	1.000	PZ	VL1166A0	RACCORDO A L BAM-BB6	1.000	PZ	VL1174C0	UGELLO CALIBRATO D1.2 MM	1.000	PZ	VL1191A0	DISTRIBUTOR E USCITA LAVAGGIO ON	1.000	PZ	VL1214A0	VALVOLA VNR BB6-BAIONET TA	1.000	PZ	VM2172A0	CLIP BLOCCAGGIO POMPA CON CIRCUITO	2.000	PZ	KVL1166A	BB6-AR6 L FITTING 5 PCS KIT	<table border="1"> <thead> <tr> <th>Code</th> <th>Description</th> <th>Qty</th> <th>UOM</th> </tr> </thead> <tbody> <tr> <td>VL1166A0</td> <td>RACCORDO A L BAM-BB6</td> <td>5.000</td> <td>PZ</td> </tr> </tbody> </table>	Code	Description	Qty	UOM	VL1166A0	RACCORDO A L BAM-BB6	5.000	PZ
			Code	Description	Qty	UOM																																																																						
TB3225B0	TB2820A-TUB O EPDM NERO 670MM	1.000	PZ																																																																									
TB3614A0	TB2820A-L=96 MM NERO EPD	1.000	PZ																																																																									
TB5361A0	TB3132A-TUB O EPDM TELAIO BIANCO-BLU 670M	1.000	PZ																																																																									
VI1220A1	VITE AUTOFIL. 4.2X11 TCS+ MARUTEX	2.000	PZ																																																																									
VL1019A0	POMPA DETERGENTE VIBRAZIONE	1.000	PZ																																																																									
VL1047A1	PORTAGOMM A D6 CODOLO D8	1.000	PZ																																																																									
VL1054B0	DISTRIBUTOR E INGRESSI LAVAGGIO ON	1.000	PZ																																																																									
VL1102A1	FILTRO IN LINEA DET. + VNR BARBED 6 MM	1.000	PZ																																																																									
VL1128A1	VALVOLA VNR BARBED D6	1.000	PZ																																																																									
VL1166A0	RACCORDO A L BAM-BB6	1.000	PZ																																																																									
VL1174C0	UGELLO CALIBRATO D1.2 MM	1.000	PZ																																																																									
VL1191A0	DISTRIBUTOR E USCITA LAVAGGIO ON	1.000	PZ																																																																									
VL1214A0	VALVOLA VNR BB6-BAIONET TA	1.000	PZ																																																																									
VM2172A0	CLIP BLOCCAGGIO POMPA CON CIRCUITO	2.000	PZ																																																																									
Code	Description	Qty	UOM																																																																									
VL1166A0	RACCORDO A L BAM-BB6	5.000	PZ																																																																									





COMPONENT			SPARE PART																										
Code	Description	Image	Code	Description	Kit components																								
VM2172A	CLIP BLOCCAGGIO POMPA CON CIRCUITO		VM2172A0	CLIP BLOCCAGGIO POMPA CON CIRCUITO																									
0H2561A	6 S. DOOR COUNTERBRACKET		0H2561A0	6 S. DOOR COUNTERBRACKET																									
VI1995A	VITE M5x25 TCEI INOX		VI1995A0	VITE M5x25 TCEI INOX																									
VM1240A	TAPPO NYLON SUPPORTO CONTROSTAFFA		KVM1240A	4 PCS COUNTER BRACKET SUPPORT CAP KIT	<table border="1"> <thead> <tr> <th>Code</th> <th>Description</th> <th>Qty</th> <th>UOM</th> </tr> </thead> <tbody> <tr> <td>VM1240A0</td> <td>TAPPO NYLON SUPPORTO CONTROSTAFFA</td> <td>4.000</td> <td>PZ</td> </tr> </tbody> </table>	Code	Description	Qty	UOM	VM1240A0	TAPPO NYLON SUPPORTO CONTROSTAFFA	4.000	PZ																
Code	Description	Qty	UOM																										
VM1240A0	TAPPO NYLON SUPPORTO CONTROSTAFFA	4.000	PZ																										
VM2273A	STAFFA INFERIORE PORTA MM SX		KVM2273A	MIND.Maps DOOR LOWER LEFT BRACKET KIT	<table border="1"> <thead> <tr> <th>Code</th> <th>Description</th> <th>Qty</th> <th>UOM</th> </tr> </thead> <tbody> <tr> <td>0H7330A0</td> <td>RONDELLA STAFFA INFERIORE PORTA MM</td> <td>2.000</td> <td>PZ</td> </tr> <tr> <td>VI1995A0</td> <td>VITE M5x25 TCEI INOX</td> <td>4.000</td> <td>PZ</td> </tr> <tr> <td>VM2273A1</td> <td>STAFFA INFERIORE PORTA MM SX</td> <td>1.000</td> <td>PZ</td> </tr> <tr> <td>VM2352A0</td> <td>TAPPO SX COPRI VITI STAFFA PORTA INF M</td> <td>1.000</td> <td>PZ</td> </tr> <tr> <td>VM2353A0</td> <td>TAPPO DX COPRI VITI STAFFA PORTA INF M</td> <td>1.000</td> <td>PZ</td> </tr> </tbody> </table>	Code	Description	Qty	UOM	0H7330A0	RONDELLA STAFFA INFERIORE PORTA MM	2.000	PZ	VI1995A0	VITE M5x25 TCEI INOX	4.000	PZ	VM2273A1	STAFFA INFERIORE PORTA MM SX	1.000	PZ	VM2352A0	TAPPO SX COPRI VITI STAFFA PORTA INF M	1.000	PZ	VM2353A0	TAPPO DX COPRI VITI STAFFA PORTA INF M	1.000	PZ
Code	Description	Qty	UOM																										
0H7330A0	RONDELLA STAFFA INFERIORE PORTA MM	2.000	PZ																										
VI1995A0	VITE M5x25 TCEI INOX	4.000	PZ																										
VM2273A1	STAFFA INFERIORE PORTA MM SX	1.000	PZ																										
VM2352A0	TAPPO SX COPRI VITI STAFFA PORTA INF M	1.000	PZ																										
VM2353A0	TAPPO DX COPRI VITI STAFFA PORTA INF M	1.000	PZ																										



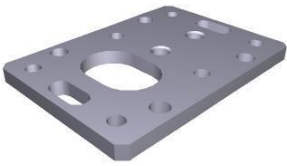

COMPONENT			SPARE PART										
Code	Description	Image	Code	Description	Kit components								
VM2352A	TAPPO SX COPRI VITI STAFFA PORTA INF MM		VM2352A0	TAPPO SX COPRI VITI STAFFA PORTA INF MM									
VM2353A	TAPPO DX COPRI VITI STAFFA PORTA INF MM		VM2353A0	TAPPO DX COPRI VITI STAFFA PORTA INF MM									
0H2561A	6 S. DOOR COUNTERBRACKET		0H2561A0	6 S. DOOR COUNTERBRACKET									
VI1995A	VITE M5x25 TCEI INOX		VI1995A0	VITE M5x25 TCEI INOX									
VM1240A	TAPPO NYLON SUPPORTO CONTROSTAFFA		KVM1240A	4 PCS COUNTER BRACKET SUPPORT CAP KIT	<table border="1"> <thead> <tr> <th>Code</th> <th>Description</th> <th>Qty</th> <th>UOM</th> </tr> </thead> <tbody> <tr> <td>VM1240A0</td> <td>TAPPO NYLON SUPPORTO CONTROSTAF FA</td> <td>4.000</td> <td>PZ</td> </tr> </tbody> </table>	Code	Description	Qty	UOM	VM1240A0	TAPPO NYLON SUPPORTO CONTROSTAF FA	4.000	PZ
Code	Description	Qty	UOM										
VM1240A0	TAPPO NYLON SUPPORTO CONTROSTAF FA	4.000	PZ										











COMPONENT			SPARE PART																										
Code	Description	Image	Code	Description	Kit components																								
VM2271A	STAFFA SUPERIORE PORTA MM SX		KVM2271A	MIND.MAPS UPPER LEFT DOOR BRACKET KIT	<table border="1"> <thead> <tr> <th>Code</th> <th>Description</th> <th>Qty</th> <th>UOM</th> </tr> </thead> <tbody> <tr> <td>VI1220A1</td> <td>VITE AUTOFIL. 4.2X11 TCS+ MARUTEX</td> <td>2.000</td> <td>PZ</td> </tr> <tr> <td>VI1995A0</td> <td>VITE M5x25 TCEI INOX</td> <td>4.000</td> <td>PZ</td> </tr> <tr> <td>VI1997A0</td> <td>RONDELLA PIANA 5x10X1 ZN</td> <td>4.000</td> <td>PZ</td> </tr> <tr> <td>VM2271A0</td> <td>STAFFA SUPERIORE PORTA MM SX</td> <td>1.000</td> <td>PZ</td> </tr> <tr> <td>VM2298A0</td> <td>COPERCHIO SUP STAFFA PORTA MM</td> <td>1.000</td> <td>PZ</td> </tr> </tbody> </table>	Code	Description	Qty	UOM	VI1220A1	VITE AUTOFIL. 4.2X11 TCS+ MARUTEX	2.000	PZ	VI1995A0	VITE M5x25 TCEI INOX	4.000	PZ	VI1997A0	RONDELLA PIANA 5x10X1 ZN	4.000	PZ	VM2271A0	STAFFA SUPERIORE PORTA MM SX	1.000	PZ	VM2298A0	COPERCHIO SUP STAFFA PORTA MM	1.000	PZ
Code	Description	Qty	UOM																										
VI1220A1	VITE AUTOFIL. 4.2X11 TCS+ MARUTEX	2.000	PZ																										
VI1995A0	VITE M5x25 TCEI INOX	4.000	PZ																										
VI1997A0	RONDELLA PIANA 5x10X1 ZN	4.000	PZ																										
VM2271A0	STAFFA SUPERIORE PORTA MM SX	1.000	PZ																										
VM2298A0	COPERCHIO SUP STAFFA PORTA MM	1.000	PZ																										
VM2298A	COPERCHIO SUP STAFFA PORTA MM		KVM2298A	MIND.Maps DOOR UPPER BRACKET COVER KIT	<table border="1"> <thead> <tr> <th>Code</th> <th>Description</th> <th>Qty</th> <th>UOM</th> </tr> </thead> <tbody> <tr> <td>VI1220A1</td> <td>VITE AUTOFIL. 4.2X11 TCS+ MARUTEX</td> <td>2.000</td> <td>PZ</td> </tr> <tr> <td>VM2298A0</td> <td>COPERCHIO SUP STAFFA PORTA MM</td> <td>1.000</td> <td>PZ</td> </tr> </tbody> </table>	Code	Description	Qty	UOM	VI1220A1	VITE AUTOFIL. 4.2X11 TCS+ MARUTEX	2.000	PZ	VM2298A0	COPERCHIO SUP STAFFA PORTA MM	1.000	PZ												
Code	Description	Qty	UOM																										
VI1220A1	VITE AUTOFIL. 4.2X11 TCS+ MARUTEX	2.000	PZ																										
VM2298A0	COPERCHIO SUP STAFFA PORTA MM	1.000	PZ																										
0H2561A	6 S. DOOR COUNTERBRACKET		0H2561A0	6 S. DOOR COUNTERBRACKET																									
VE1020B	MICROINT. PORTA MAGNETICO CON MINIFIT 2P		KVE1020B	MICROSWITCH KIT	<table border="1"> <thead> <tr> <th>Code</th> <th>Description</th> <th>Qty</th> <th>UOM</th> </tr> </thead> <tbody> <tr> <td>CE1030A0</td> <td>FASTON FEMMINA 6.3X0.8 0.5-1mmq</td> <td>2.000</td> <td>PZ</td> </tr> <tr> <td>CE1660A0</td> <td>COPRI FASTON FEMMINA 6.3X0.8</td> <td>2.000</td> <td>PZ</td> </tr> <tr> <td>CE1730A0</td> <td>CAVO PVC NP 2 X AWG22 STYLE 2095</td> <td>0.150</td> <td>M</td> </tr> <tr> <td>CE1740A0</td> <td>TERMINALE MINIFIT MASCHIO</td> <td>2.000</td> <td>PZ</td> </tr> <tr> <td>CE1745A0</td> <td>CONNETTORE MINIFIT FEMMINA 2 VI</td> <td>1.000</td> <td>PZ</td> </tr> </tbody> </table>	Code	Description	Qty	UOM	CE1030A0	FASTON FEMMINA 6.3X0.8 0.5-1mmq	2.000	PZ	CE1660A0	COPRI FASTON FEMMINA 6.3X0.8	2.000	PZ	CE1730A0	CAVO PVC NP 2 X AWG22 STYLE 2095	0.150	M	CE1740A0	TERMINALE MINIFIT MASCHIO	2.000	PZ	CE1745A0	CONNETTORE MINIFIT FEMMINA 2 VI	1.000	PZ
Code	Description	Qty	UOM																										
CE1030A0	FASTON FEMMINA 6.3X0.8 0.5-1mmq	2.000	PZ																										
CE1660A0	COPRI FASTON FEMMINA 6.3X0.8	2.000	PZ																										
CE1730A0	CAVO PVC NP 2 X AWG22 STYLE 2095	0.150	M																										
CE1740A0	TERMINALE MINIFIT MASCHIO	2.000	PZ																										
CE1745A0	CONNETTORE MINIFIT FEMMINA 2 VI	1.000	PZ																										



COMPONENT			SPARE PART																		
Code	Description	Image	Code	Description	Kit components																
VE1020B	MICROINT. PORTA MAGNETICO CON MINIFIT 2P		KVE1020B	MICROSWITCH KIT	<table border="1"> <thead> <tr> <th>Code</th> <th>Description</th> <th>Qty</th> <th>UOM</th> </tr> </thead> <tbody> <tr> <td>VE1020B0</td> <td>MICROINT. PORTA MAGNETICO CON MINIFIT 2</td> <td>1.000</td> <td>PZ</td> </tr> <tr> <td>VE1030A1</td> <td>CALAMITA D=22,9mm PER MICROPORTA</td> <td>1.000</td> <td>PZ</td> </tr> <tr> <td>VI1192A0</td> <td>DADO M10X0.75 H3 OTTONE NICHELATO</td> <td>1.000</td> <td>PZ</td> </tr> </tbody> </table>	Code	Description	Qty	UOM	VE1020B0	MICROINT. PORTA MAGNETICO CON MINIFIT 2	1.000	PZ	VE1030A1	CALAMITA D=22,9mm PER MICROPORTA	1.000	PZ	VI1192A0	DADO M10X0.75 H3 OTTONE NICHELATO	1.000	PZ
					Code	Description	Qty	UOM													
					VE1020B0	MICROINT. PORTA MAGNETICO CON MINIFIT 2	1.000	PZ													
					VE1030A1	CALAMITA D=22,9mm PER MICROPORTA	1.000	PZ													
VI1192A0	DADO M10X0.75 H3 OTTONE NICHELATO	1.000	PZ																		
<table border="1"> <thead> <tr> <th>Code</th> <th>Description</th> <th>Qty</th> <th>UOM</th> </tr> </thead> <tbody> <tr> <td>VM1240A0</td> <td>TAPPO NYLON SUPPORTO CONTROSTAFFA</td> <td>4.000</td> <td>PZ</td> </tr> </tbody> </table>	Code	Description	Qty	UOM	VM1240A0	TAPPO NYLON SUPPORTO CONTROSTAFFA	4.000	PZ													
Code	Description	Qty	UOM																		
VM1240A0	TAPPO NYLON SUPPORTO CONTROSTAFFA	4.000	PZ																		
<table border="1"> <thead> <tr> <th>Code</th> <th>Description</th> <th>Qty</th> <th>UOM</th> </tr> </thead> <tbody> <tr> <td>VP1075A0</td> <td>PIASTRINA SUPPORTO MICROPORTA PLUS/1/ZER</td> <td>1.000</td> <td>PZ</td> </tr> </tbody> </table>	Code	Description	Qty	UOM	VP1075A0	PIASTRINA SUPPORTO MICROPORTA PLUS/1/ZER	1.000	PZ													
Code	Description	Qty	UOM																		
VP1075A0	PIASTRINA SUPPORTO MICROPORTA PLUS/1/ZER	1.000	PZ																		
<table border="1"> <thead> <tr> <th>Code</th> <th>Description</th> <th>Qty</th> <th>UOM</th> </tr> </thead> <tbody> <tr> <td>0H2561A0</td> <td>6 S. DOOR COUNTERBRACKET</td> <td></td> <td></td> </tr> </tbody> </table>	Code	Description	Qty	UOM	0H2561A0	6 S. DOOR COUNTERBRACKET															
Code	Description	Qty	UOM																		
0H2561A0	6 S. DOOR COUNTERBRACKET																				
VM1240A	TAPPO NYLON SUPPORTO CONTROSTAFFA		KVM1240A	4 PCS COUNTER BRACKET SUPPORT CAP KIT	<table border="1"> <thead> <tr> <th>Code</th> <th>Description</th> <th>Qty</th> <th>UOM</th> </tr> </thead> <tbody> <tr> <td>VM1240A0</td> <td>TAPPO NYLON SUPPORTO CONTROSTAF FA</td> <td>4.000</td> <td>PZ</td> </tr> </tbody> </table>	Code	Description	Qty	UOM	VM1240A0	TAPPO NYLON SUPPORTO CONTROSTAF FA	4.000	PZ								
Code	Description	Qty	UOM																		
VM1240A0	TAPPO NYLON SUPPORTO CONTROSTAF FA	4.000	PZ																		

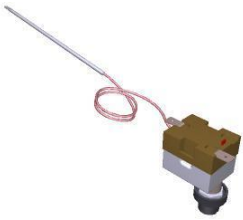

COMPONENT			SPARE PART																		
Code	Description	Image	Code	Description	Kit components																
VM2310A	PIASTRINA A L COPRI FORI STAFFA SUP		KVM2310A	UPPER BRACKET HOLE COVER KIT	<table border="1"> <thead> <tr> <th>Code</th> <th>Description</th> <th>Qty</th> <th>UOM</th> </tr> </thead> <tbody> <tr> <td>VM2310A0</td> <td>PIASTRINA A L COPRI FORI STAFFA SUP</td> <td>1.000</td> <td>PZ</td> </tr> </tbody> </table>	Code	Description	Qty	UOM	VM2310A0	PIASTRINA A L COPRI FORI STAFFA SUP	1.000	PZ								
Code	Description	Qty	UOM																		
VM2310A0	PIASTRINA A L COPRI FORI STAFFA SUP	1.000	PZ																		
0H1019A	LAMIERA RINFORZO PIEDI H100 CT		K0H1019A	CT REINF. PLATE FOR H100 FEET	<table border="1"> <thead> <tr> <th>Code</th> <th>Description</th> <th>Qty</th> <th>UOM</th> </tr> </thead> <tbody> <tr> <td>0H1019A2</td> <td>LAMIERA RINFORZO PIEDI H100 CT</td> <td>1.000</td> <td>PZ</td> </tr> <tr> <td>V11739A0</td> <td>INSERTO FILETTATO M10 FTT/E ZN STP</td> <td>2.000</td> <td>PZ</td> </tr> </tbody> </table>	Code	Description	Qty	UOM	0H1019A2	LAMIERA RINFORZO PIEDI H100 CT	1.000	PZ	V11739A0	INSERTO FILETTATO M10 FTT/E ZN STP	2.000	PZ				
Code	Description	Qty	UOM																		
0H1019A2	LAMIERA RINFORZO PIEDI H100 CT	1.000	PZ																		
V11739A0	INSERTO FILETTATO M10 FTT/E ZN STP	2.000	PZ																		
PD1100A	PD1100A0		KPD1074A	Mind.Maps H100 FOOT KIT	<table border="1"> <thead> <tr> <th>Code</th> <th>Description</th> <th>Qty</th> <th>UOM</th> </tr> </thead> <tbody> <tr> <td>PD1101A0</td> <td>ASSEMBLATO PIEDE H100 -M</td> <td>1.000</td> <td>PZ</td> </tr> <tr> <td>V11950A0</td> <td>VITE AUTOFORANT E 4,2X13 TCB INOX</td> <td>2.000</td> <td>PZ</td> </tr> <tr> <td>V11972A0</td> <td>VITE TCEI M10X25 ZN</td> <td>1.000</td> <td>PZ</td> </tr> </tbody> </table>	Code	Description	Qty	UOM	PD1101A0	ASSEMBLATO PIEDE H100 -M	1.000	PZ	V11950A0	VITE AUTOFORANT E 4,2X13 TCB INOX	2.000	PZ	V11972A0	VITE TCEI M10X25 ZN	1.000	PZ
Code	Description	Qty	UOM																		
PD1101A0	ASSEMBLATO PIEDE H100 -M	1.000	PZ																		
V11950A0	VITE AUTOFORANT E 4,2X13 TCB INOX	2.000	PZ																		
V11972A0	VITE TCEI M10X25 ZN	1.000	PZ																		
PD1074A	H=100 SQUARE FOO		KPD1074A	Mind.Maps H100 FOOT KIT	<table border="1"> <thead> <tr> <th>Code</th> <th>Description</th> <th>Qty</th> <th>UOM</th> </tr> </thead> <tbody> <tr> <td>PD1101A0</td> <td>ASSEMBLATO PIEDE H100 -M</td> <td>1.000</td> <td>PZ</td> </tr> <tr> <td>V11950A0</td> <td>VITE AUTOFORANT E 4,2X13 TCB INOX</td> <td>2.000</td> <td>PZ</td> </tr> <tr> <td>V11972A0</td> <td>VITE TCEI M10X25 ZN</td> <td>1.000</td> <td>PZ</td> </tr> </tbody> </table>	Code	Description	Qty	UOM	PD1101A0	ASSEMBLATO PIEDE H100 -M	1.000	PZ	V11950A0	VITE AUTOFORANT E 4,2X13 TCB INOX	2.000	PZ	V11972A0	VITE TCEI M10X25 ZN	1.000	PZ
Code	Description	Qty	UOM																		
PD1101A0	ASSEMBLATO PIEDE H100 -M	1.000	PZ																		
V11950A0	VITE AUTOFORANT E 4,2X13 TCB INOX	2.000	PZ																		
V11972A0	VITE TCEI M10X25 ZN	1.000	PZ																		
PD1075A	STAFFA BLOCCAGGIO PIEDE PD1074		KPD1075A	OVEN FOOT STOPPING BRACKET 4 PCS KIT	<table border="1"> <thead> <tr> <th>Code</th> <th>Description</th> <th>Qty</th> <th>UOM</th> </tr> </thead> <tbody> <tr> <td>PD1075A1</td> <td>STAFFA BLOCCAGGIO PIEDE PD1074</td> <td>4.000</td> <td>PZ</td> </tr> <tr> <td>V11950A0</td> <td>VITE AUTOFORANT E 4,2X13 TCB INOX</td> <td>8.000</td> <td>PZ</td> </tr> </tbody> </table>	Code	Description	Qty	UOM	PD1075A1	STAFFA BLOCCAGGIO PIEDE PD1074	4.000	PZ	V11950A0	VITE AUTOFORANT E 4,2X13 TCB INOX	8.000	PZ				
Code	Description	Qty	UOM																		
PD1075A1	STAFFA BLOCCAGGIO PIEDE PD1074	4.000	PZ																		
V11950A0	VITE AUTOFORANT E 4,2X13 TCB INOX	8.000	PZ																		

COMPONENT			SPARE PART																										
Code	Description	Image	Code	Description	Kit components																								
TR1136A	TERMOSTATO SIC. UNIP. 318°C -0/+24		KTR1136A	318°C -0/+24 SAFETY THERMOSTAT KIT	<table border="1"> <thead> <tr> <th>Code</th> <th>Description</th> <th>Qty</th> <th>UOM</th> </tr> </thead> <tbody> <tr> <td>0H8120A0</td> <td>COPERCHIO INGRESSO BULBO XEVL</td> <td>1.000</td> <td>PZ</td> </tr> <tr> <td>GN1531A0</td> <td>GUARNIZIONE TENUTA INGRESSO BULBO</td> <td>1.000</td> <td>PZ</td> </tr> <tr> <td>SL1045A0</td> <td>SILICONE ANTRACITE S57 80 ml</td> <td>1.000</td> <td>PZ</td> </tr> <tr> <td>TR1136A0</td> <td>TERMOSTATO SIC. UNIP. 318°C -0/+24</td> <td>1.000</td> <td>PZ</td> </tr> <tr> <td>VI1220A1</td> <td>VITE AUTOFIL. 4.2X11 TCS+ MARUTEX</td> <td>3.000</td> <td>PZ</td> </tr> </tbody> </table>	Code	Description	Qty	UOM	0H8120A0	COPERCHIO INGRESSO BULBO XEVL	1.000	PZ	GN1531A0	GUARNIZIONE TENUTA INGRESSO BULBO	1.000	PZ	SL1045A0	SILICONE ANTRACITE S57 80 ml	1.000	PZ	TR1136A0	TERMOSTATO SIC. UNIP. 318°C -0/+24	1.000	PZ	VI1220A1	VITE AUTOFIL. 4.2X11 TCS+ MARUTEX	3.000	PZ
Code	Description	Qty	UOM																										
0H8120A0	COPERCHIO INGRESSO BULBO XEVL	1.000	PZ																										
GN1531A0	GUARNIZIONE TENUTA INGRESSO BULBO	1.000	PZ																										
SL1045A0	SILICONE ANTRACITE S57 80 ml	1.000	PZ																										
TR1136A0	TERMOSTATO SIC. UNIP. 318°C -0/+24	1.000	PZ																										
VI1220A1	VITE AUTOFIL. 4.2X11 TCS+ MARUTEX	3.000	PZ																										
VM1991A	CASSETTO RACCOGLI GOCCE 750		KVM1991A	E SERIES CHEFTOP DRIP TRAY	<table border="1"> <thead> <tr> <th>Code</th> <th>Description</th> <th>Qty</th> <th>UOM</th> </tr> </thead> <tbody> <tr> <td>VM1220A0</td> <td>CLIP FISSAGGIO CASSETTO RACCOGLIGO CCE</td> <td>4.000</td> <td>PZ</td> </tr> <tr> <td>VM1991A0</td> <td>CASSETTO RACCOGLI GOCCE 750</td> <td>1.000</td> <td>PZ</td> </tr> <tr> <td>VM2074A1</td> <td>CLIP CON VITE PER SUPPORTO CASSETTO</td> <td>4.000</td> <td>PZ</td> </tr> </tbody> </table>	Code	Description	Qty	UOM	VM1220A0	CLIP FISSAGGIO CASSETTO RACCOGLIGO CCE	4.000	PZ	VM1991A0	CASSETTO RACCOGLI GOCCE 750	1.000	PZ	VM2074A1	CLIP CON VITE PER SUPPORTO CASSETTO	4.000	PZ								
Code	Description	Qty	UOM																										
VM1220A0	CLIP FISSAGGIO CASSETTO RACCOGLIGO CCE	4.000	PZ																										
VM1991A0	CASSETTO RACCOGLI GOCCE 750	1.000	PZ																										
VM2074A1	CLIP CON VITE PER SUPPORTO CASSETTO	4.000	PZ																										
VM2035A	SUPPORTO PER TUBO DI SCARICO		KVM2035A	DRAIN PIPE SUPPORT 2 PCS. KI	<table border="1"> <thead> <tr> <th>Code</th> <th>Description</th> <th>Qty</th> <th>UOM</th> </tr> </thead> <tbody> <tr> <td>VM2035A0</td> <td>SUPPORTO PER TUBO DI SCARICO</td> <td>2.000</td> <td>PZ</td> </tr> </tbody> </table>	Code	Description	Qty	UOM	VM2035A0	SUPPORTO PER TUBO DI SCARICO	2.000	PZ																
Code	Description	Qty	UOM																										
VM2035A0	SUPPORTO PER TUBO DI SCARICO	2.000	PZ																										
VM2061A	ACCESSORIES CABLES WALL PASSING		KVM1505A	THROUGH-WALL CONNECTION+DIAP HRAGM KIT	<table border="1"> <thead> <tr> <th>Code</th> <th>Description</th> <th>Qty</th> <th>UOM</th> </tr> </thead> <tbody> <tr> <td>VI1220A1</td> <td>VITE AUTOFIL. 4.2X11 TCS+ MARUTEX</td> <td>1.000</td> <td>PZ</td> </tr> <tr> <td>VM1505A0</td> <td>PASSAPARET E CON DIAFRAMMA</td> <td>3.000</td> <td>PZ</td> </tr> <tr> <td>VM2055A0</td> <td>PASSAPARET E CAVI ACCESSORI SUP.</td> <td>1.000</td> <td>PZ</td> </tr> <tr> <td>VM2056A0</td> <td>PASSAPARET E CAVI ACCESSORI INF.</td> <td>1.000</td> <td>PZ</td> </tr> </tbody> </table>	Code	Description	Qty	UOM	VI1220A1	VITE AUTOFIL. 4.2X11 TCS+ MARUTEX	1.000	PZ	VM1505A0	PASSAPARET E CON DIAFRAMMA	3.000	PZ	VM2055A0	PASSAPARET E CAVI ACCESSORI SUP.	1.000	PZ	VM2056A0	PASSAPARET E CAVI ACCESSORI INF.	1.000	PZ				
Code	Description	Qty	UOM																										
VI1220A1	VITE AUTOFIL. 4.2X11 TCS+ MARUTEX	1.000	PZ																										
VM1505A0	PASSAPARET E CON DIAFRAMMA	3.000	PZ																										
VM2055A0	PASSAPARET E CAVI ACCESSORI SUP.	1.000	PZ																										
VM2056A0	PASSAPARET E CAVI ACCESSORI INF.	1.000	PZ																										

COMPONENT			SPARE PART																		
Code	Description	Image	Code	Description	Kit components																
VM2074A	CLIP CON VITE PER SUPPORTO CASSETTO		KVM1220A	CT/BT DRIP TRAY FIXING CLIPS 4PCS KIT	<table border="1"> <thead> <tr> <th>Code</th> <th>Description</th> <th>Qty</th> <th>UOM</th> </tr> </thead> <tbody> <tr> <td>VI1220A1</td> <td>VITE AUTOFIL 4.2X11 TCS+ MARUTEX</td> <td>4.000</td> <td>PZ</td> </tr> <tr> <td>VM1220A0</td> <td>CLIP FISSAGGIO CASSETTO RACCOGLIGO CCE</td> <td>4.000</td> <td>PZ</td> </tr> <tr> <td>VM2074A1</td> <td>CLIP CON VITE PER SUPPORTO CASSETTO</td> <td>4.000</td> <td>PZ</td> </tr> </tbody> </table>	Code	Description	Qty	UOM	VI1220A1	VITE AUTOFIL 4.2X11 TCS+ MARUTEX	4.000	PZ	VM1220A0	CLIP FISSAGGIO CASSETTO RACCOGLIGO CCE	4.000	PZ	VM2074A1	CLIP CON VITE PER SUPPORTO CASSETTO	4.000	PZ
Code	Description	Qty	UOM																		
VI1220A1	VITE AUTOFIL 4.2X11 TCS+ MARUTEX	4.000	PZ																		
VM1220A0	CLIP FISSAGGIO CASSETTO RACCOGLIGO CCE	4.000	PZ																		
VM2074A1	CLIP CON VITE PER SUPPORTO CASSETTO	4.000	PZ																		
VM2249A	ANGOLO FACCIATA MUFFOLA PPS		KVM2249A	CHAMBER FRONT PROFILE CORNER KIT	<table border="1"> <thead> <tr> <th>Code</th> <th>Description</th> <th>Qty</th> <th>UOM</th> </tr> </thead> <tbody> <tr> <td>VM2249A0</td> <td>ANGOLO FACCIATA MUFFOLA PPS</td> <td>1.000</td> <td>PZ</td> </tr> </tbody> </table>	Code	Description	Qty	UOM	VM2249A0	ANGOLO FACCIATA MUFFOLA PPS	1.000	PZ								
Code	Description	Qty	UOM																		
VM2249A0	ANGOLO FACCIATA MUFFOLA PPS	1.000	PZ																		
VM2311A	PIASTRINA COPRI VITI		KVM2311A	SCREWS COVER PLATE KIT	<table border="1"> <thead> <tr> <th>Code</th> <th>Description</th> <th>Qty</th> <th>UOM</th> </tr> </thead> <tbody> <tr> <td>VM2311A0</td> <td>PIASTRINA COPRI VITI</td> <td>1.000</td> <td>PZ</td> </tr> </tbody> </table>	Code	Description	Qty	UOM	VM2311A0	PIASTRINA COPRI VITI	1.000	PZ								
Code	Description	Qty	UOM																		
VM2311A0	PIASTRINA COPRI VITI	1.000	PZ																		
VM2450A	PASSAPARETE 3 TUBI		KVM2450A	3 PIPES THROUGH-WALL CONNECTION KIT	<table border="1"> <thead> <tr> <th>Code</th> <th>Description</th> <th>Qty</th> <th>UOM</th> </tr> </thead> <tbody> <tr> <td>VM2450A0</td> <td>PASSAPARETE 3 TUBI</td> <td>1.000</td> <td>PZ</td> </tr> </tbody> </table>	Code	Description	Qty	UOM	VM2450A0	PASSAPARETE 3 TUBI	1.000	PZ								
Code	Description	Qty	UOM																		
VM2450A0	PASSAPARETE 3 TUBI	1.000	PZ																		
VP1121A	LEFT-RIGHT WATER SEALING CAP		VP1121A0	LEFT-RIGHT WATER SEALING CAP																	





COMPONENT			SPARE PART																		
Code	Description	Image	Code	Description	Kit components																
VP1168B	ANELLO TENUTA CAMINO 1 VITE		KVP1168B	1 SCREW CHIMNEY SEALING RING KIT	<table border="1"> <thead> <tr> <th>Code</th> <th>Description</th> <th>Qty</th> <th>UOM</th> </tr> </thead> <tbody> <tr> <td>GN1032A0</td> <td>O-RING CAMINO DID 47x3,5 VITON SH70</td> <td>1.000</td> <td>PZ</td> </tr> <tr> <td>V1168A0</td> <td>VITE AUTOFIL 4.2x9.5 TCBS+ ZN-NI NERA</td> <td>1.000</td> <td>PZ</td> </tr> <tr> <td>VP1168B0</td> <td>ANELLO TENUTA CAMINO 1 VIT</td> <td>1.000</td> <td>PZ</td> </tr> </tbody> </table>	Code	Description	Qty	UOM	GN1032A0	O-RING CAMINO DID 47x3,5 VITON SH70	1.000	PZ	V1168A0	VITE AUTOFIL 4.2x9.5 TCBS+ ZN-NI NERA	1.000	PZ	VP1168B0	ANELLO TENUTA CAMINO 1 VIT	1.000	PZ
Code	Description	Qty	UOM																		
GN1032A0	O-RING CAMINO DID 47x3,5 VITON SH70	1.000	PZ																		
V1168A0	VITE AUTOFIL 4.2x9.5 TCBS+ ZN-NI NERA	1.000	PZ																		
VP1168B0	ANELLO TENUTA CAMINO 1 VIT	1.000	PZ																		

ASM2921B/0.D08 - Door - FRONT



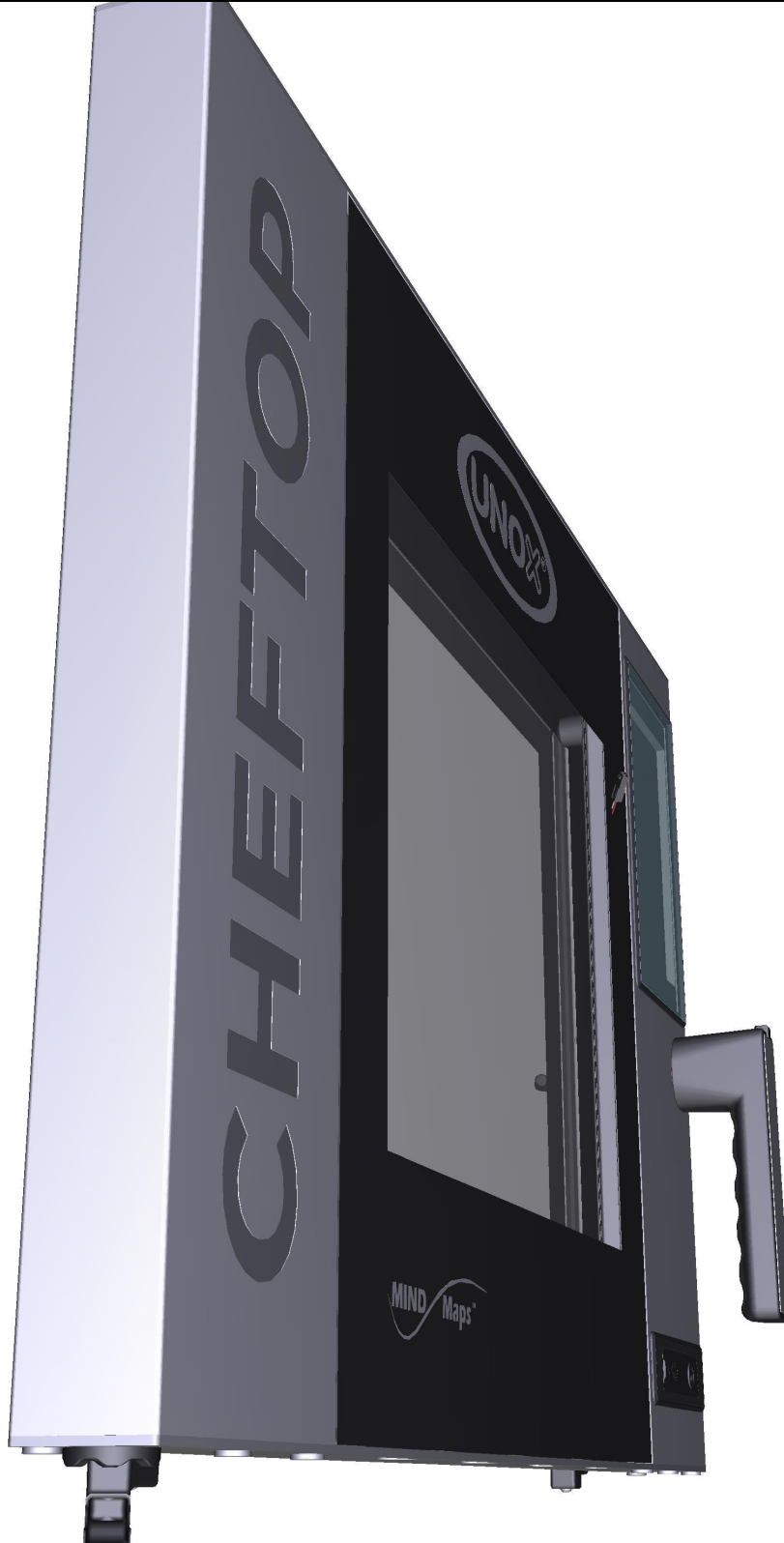

ASM2921B/0.D08 - Door - REAR





COMPONENT			SPARE PART					
Code	Description	Image	Code	Description	Kit components			
0B1106A	COLONNINA ESTERNA SX PORTA XEVC-0511-E		KDR1325A	0511 ZERO RIGHT -M EXTERNAL DOOR	Code	Description	Qty	UOM
					0B1106A0	COLONNINA ESTERNA SX PORTA XEVC-0511-E	1.000	PZ
					0B1107A1	COLONNINA INTERNA SX PORTA XEVC-0511-E	1.000	PZ
					0B1108B1	COLONNINA ESTERNA DX PORTA XEVC-0511	1.000	PZ
					0B1109A1	COLONNINA INTERNA DX PORTA XEVC-0511-E	1.000	PZ
					0B1122B0	TRAVERSO INFERIORE PORTA 750 MMc	1.000	PZ
					0B1166A1	PROFILO SUPPORTO VETRO EST XEVC-0511-E	2.000	PZ
					0B1216B0	TRAVERSO SUPERIORE PORTA 750 2V MMc	1.000	PZ
					0B1217A1	TRAVERSO SUPERIORE INT PORTA 750 S6 2V	1.000	PZ
					0H2892A0	LAMIERINO TAPPO SUP BARRA LED	1.000	PZ
					0H2893A0	LAMIERINO TAPPO INF BARRA LED	1.000	PZ
					CE1096A0	CAVO BUS MICROFIT 4POLI 3 M	1.000	PZ
					CE1285A0	FERRITE EMI ROUND MOD. 2643801502	2.000	PZ
					CE1851A0	CAVO Y MICROFIT 2P M-F-F AWG22	1.000	PZ
					CE2001A0	CAVO MICROFIT 2PM-100-2PM 2AWG22	1.000	PZ

COMPONENT			SPARE PART					
Code	Description	Image	Code	Description	Kit components			
OB1106A	COLONNINA ESTERNA SX PORTA XEVC-0511-E		KDR1325A	0511 ZERO RIGHT -M EXTERNAL DOOR	Code	Description	Qty	UOM
					CE2002A0	CAVO MICROFIT 2PM-100-AMP MODU2 2AWG22	1.000	PZ
					GN1525A0	O-RING D.INT 9.5xSP 1 NBR 7	1.000	PZ
					LP1019A0	BARRA ILLUMINAZION E LED MM L200 E415	1.000	PZ
					MG1099A1	ASSIEME MANIGLIA COMPLETO MMc	1.000	PZ
					SL1170A1	SILICONE ANTRACITE S57 CARTUCCIA 310 ml	30.000	ML
					SL1221A0	SILICONE SUP VETRO EXT GN1/1	1.000	PZ
					SL1222A0	SILICONE LAT VETRO EXT 0511	4.000	PZ
					VE1030A1	CALAMITA D=22,9mm PER MICROPORTA	1.000	PZ
					VI1034A0	RONDELLA PIANA 8.4x16x1 INOX	1.000	PZ
					VI1074A0	VITE PER PLASTICA 4X16 TPBS+ INOX	1.000	PZ
					VI1174A0	VITE 5X20 PER PLASTICA ZN-NI	16.000	PZ
					VI1220A1	VITE AUTOFIL. 4.2X11 TCS+ MARUTEX	26.000	PZ
					VI1996A0	VITE M5x35 TCEI ZN	13.000	PZ
					VM1490A0	COPRI VITI MANIGLIA CHEFTOP BAKERTOP	2.000	PZ
					VM1630A1	TAPPO PREMI VETRO INTERNO	3.000	PZ
					VM1631A0	TAPPO PREMI VETRO INTERNO PLU	3.000	PZ

COMPONENT			SPARE PART																																																																													
Code	Description	Image	Code	Description	Kit components																																																																											
OB1106A	COLONNINA ESTERNA SX PORTA XEVC-0511-E		KDR1325A	0511 ZERO RIGHT -M EXTERNAL DOOR	<table border="1"> <thead> <tr> <th>Code</th> <th>Description</th> <th>Qty</th> <th>UOM</th> </tr> </thead> <tbody> <tr> <td>VM2259B0</td> <td>TAPPO INF SX PORTA S6</td> <td>1.000</td> <td>PZ</td> </tr> <tr> <td>VM2268A0</td> <td>TAPPO COPRI CALAMITA PORTA</td> <td>1.000</td> <td>PZ</td> </tr> <tr> <td>VM2274A0</td> <td>BOCCOLA SCANALATA CORTA</td> <td>1.000</td> <td>PZ</td> </tr> <tr> <td>VM2275A0</td> <td>BOCCOLA LISCIA CORTA</td> <td>1.000</td> <td>PZ</td> </tr> <tr> <td>VM2284B0</td> <td>PROFILO SALVAGOCCE SERIE 750</td> <td>1.000</td> <td>PZ</td> </tr> <tr> <td>VM2305A0</td> <td>NOTTOLINO FISSAGGIO TAPPI PORTE MM</td> <td>14.000</td> <td>PZ</td> </tr> <tr> <td>VM2312A0</td> <td>TUBETTO SX SCARICO GOCCIOLATOI O MM</td> <td>1.000</td> <td>PZ</td> </tr> <tr> <td>VM2314A0</td> <td>TAPPINO GOCCIOLATOI O MM</td> <td>1.000</td> <td>PZ</td> </tr> <tr> <td>VM2315B0</td> <td>SUPPORTO SPINGI VETRO INT MM -M</td> <td>3.000</td> <td>PZ</td> </tr> <tr> <td>VM2505B1</td> <td>SUPPORTO PREMI VETRO INT MM PLUS</td> <td>3.000</td> <td>PZ</td> </tr> <tr> <td>VM2956A0</td> <td>ASSEMBLATO TAPPO SUP DX PORTA MM -M</td> <td>1.000</td> <td>PZ</td> </tr> <tr> <td>VM2957A0</td> <td>ASSEMBLATO TAPPO INF DX PORTA MM -M</td> <td>1.000</td> <td>PZ</td> </tr> <tr> <td>VM2958A0</td> <td>ASSEMBLATO TAPPO SUP SX PORTA MM -M</td> <td>1.000</td> <td>PZ</td> </tr> <tr> <td>VP1080A0</td> <td>TAPPO SUP CERNIERA VETRO INTERNO INF</td> <td>1.000</td> <td>PZ</td> </tr> <tr> <td>VT1276A0</td> <td>VETRO ESTERNO SER. XEVC-0511-E</td> <td>1.000</td> <td>PZ</td> </tr> </tbody> </table>	Code	Description	Qty	UOM	VM2259B0	TAPPO INF SX PORTA S6	1.000	PZ	VM2268A0	TAPPO COPRI CALAMITA PORTA	1.000	PZ	VM2274A0	BOCCOLA SCANALATA CORTA	1.000	PZ	VM2275A0	BOCCOLA LISCIA CORTA	1.000	PZ	VM2284B0	PROFILO SALVAGOCCE SERIE 750	1.000	PZ	VM2305A0	NOTTOLINO FISSAGGIO TAPPI PORTE MM	14.000	PZ	VM2312A0	TUBETTO SX SCARICO GOCCIOLATOI O MM	1.000	PZ	VM2314A0	TAPPINO GOCCIOLATOI O MM	1.000	PZ	VM2315B0	SUPPORTO SPINGI VETRO INT MM -M	3.000	PZ	VM2505B1	SUPPORTO PREMI VETRO INT MM PLUS	3.000	PZ	VM2956A0	ASSEMBLATO TAPPO SUP DX PORTA MM -M	1.000	PZ	VM2957A0	ASSEMBLATO TAPPO INF DX PORTA MM -M	1.000	PZ	VM2958A0	ASSEMBLATO TAPPO SUP SX PORTA MM -M	1.000	PZ	VP1080A0	TAPPO SUP CERNIERA VETRO INTERNO INF	1.000	PZ	VT1276A0	VETRO ESTERNO SER. XEVC-0511-E	1.000	PZ	KDR1261B	0511 -M RIGHT EXTERNAL DOOR	<table border="1"> <thead> <tr> <th>Code</th> <th>Description</th> <th>Qty</th> <th>UOM</th> </tr> </thead> <tbody> <tr> <td>OB1106A0</td> <td>COLONNINA ESTERNA SX PORTA XEVC-0511-E</td> <td>1.000</td> <td>PZ</td> </tr> </tbody> </table>	Code	Description	Qty	UOM	OB1106A0	COLONNINA ESTERNA SX PORTA XEVC-0511-E	1.000	PZ
			Code	Description	Qty	UOM																																																																										
VM2259B0	TAPPO INF SX PORTA S6	1.000	PZ																																																																													
VM2268A0	TAPPO COPRI CALAMITA PORTA	1.000	PZ																																																																													
VM2274A0	BOCCOLA SCANALATA CORTA	1.000	PZ																																																																													
VM2275A0	BOCCOLA LISCIA CORTA	1.000	PZ																																																																													
VM2284B0	PROFILO SALVAGOCCE SERIE 750	1.000	PZ																																																																													
VM2305A0	NOTTOLINO FISSAGGIO TAPPI PORTE MM	14.000	PZ																																																																													
VM2312A0	TUBETTO SX SCARICO GOCCIOLATOI O MM	1.000	PZ																																																																													
VM2314A0	TAPPINO GOCCIOLATOI O MM	1.000	PZ																																																																													
VM2315B0	SUPPORTO SPINGI VETRO INT MM -M	3.000	PZ																																																																													
VM2505B1	SUPPORTO PREMI VETRO INT MM PLUS	3.000	PZ																																																																													
VM2956A0	ASSEMBLATO TAPPO SUP DX PORTA MM -M	1.000	PZ																																																																													
VM2957A0	ASSEMBLATO TAPPO INF DX PORTA MM -M	1.000	PZ																																																																													
VM2958A0	ASSEMBLATO TAPPO SUP SX PORTA MM -M	1.000	PZ																																																																													
VP1080A0	TAPPO SUP CERNIERA VETRO INTERNO INF	1.000	PZ																																																																													
VT1276A0	VETRO ESTERNO SER. XEVC-0511-E	1.000	PZ																																																																													
Code	Description	Qty	UOM																																																																													
OB1106A0	COLONNINA ESTERNA SX PORTA XEVC-0511-E	1.000	PZ																																																																													



COMPONENT			SPARE PART					
Code	Description	Image	Code	Description	Kit components			
OB1106A	COLONNINA ESTERNA SX PORTA XEVC-0511-E		KDR1261B	0511 -M RIGHT EXTERNAL DOOR	Code	Description	Qty	UOM
					0B1107A1	COLONNINA INTERNA SX PORTA XEVC-0511-E	1.000	PZ
					0B1108B1	COLONNINA ESTERNA DX PORTA XEVC-0511	1.000	PZ
					0B1109A1	COLONNINA INTERNA DX PORTA XEVC-0511-E	1.000	PZ
					0B1122B0	TRAVERSO INFERIORE PORTA 750 MMc	1.000	PZ
					0B1166A1	PROFILO SUPPORTO VETRO EST XEVC-0511-E	2.000	PZ
					0B1216B0	TRAVERSO SUPERIORE PORTA 750 2V MMc	1.000	PZ
					0B1217A1	TRAVERSO SUPERIORE INT PORTA 750 S6 2V	1.000	PZ
					CE1052A1	CAVO CONNESSION E CONTROLLO- USB MM 750m	1.000	PZ
					CE1053B0	CAVO ALIMENT BARRA LED MM MICROFIT 2P	1.000	PZ
					CE1096A0	CAVO BUS MICROFIT 4POLI 3 M	1.000	PZ
					CE1285A0	FERRITE EMI ROUND MOD. 2643801502	2.000	PZ
					GN1525A0	O-RING D.INT 9.5xSP 1 NBR 7	1.000	PZ
					LP1019A0	BARRA ILLUMINAZION E LED MM L200 E415	1.000	PZ
					LP1025A0	ESTRUSO ILLUMINAZION E NO LED MM L415	1.000	PZ

COMPONENT			SPARE PART																																																																										
Code	Description	Image	Code	Description	Kit components																																																																								
OB1106A	COLONNINA ESTERNA SX PORTA XEVC-0511-E		KDR1261B	0511 -M RIGHT EXTERNAL DOOR	<table border="1"> <thead> <tr> <th>Code</th> <th>Description</th> <th>Qty</th> <th>UOM</th> </tr> </thead> <tbody> <tr> <td>MG1099A1</td> <td>ASSIEME MANIGLIA COMPLETO MMc</td> <td>1.000</td> <td>PZ</td> </tr> <tr> <td>SL1170A1</td> <td>SILICONE ANTRACITE S57 CARTUCCIA 310 ml</td> <td>30.000</td> <td>ML</td> </tr> <tr> <td>SL1221A0</td> <td>SILICONE SUP VETRO EXT GN1/1</td> <td>1.000</td> <td>PZ</td> </tr> <tr> <td>SL1222A0</td> <td>SILICONE LAT VETRO EXT 0511</td> <td>4.000</td> <td>PZ</td> </tr> <tr> <td>VE1030A1</td> <td>CALAMITA D=22,9mm PER MICROPORTA</td> <td>1.000</td> <td>PZ</td> </tr> <tr> <td>VI1034A0</td> <td>RONDELLA PIANA 8.4x16x1 INOX</td> <td>1.000</td> <td>PZ</td> </tr> <tr> <td>VI1074A0</td> <td>VITE PER PLASTICA 4X16 TPBS+ INOX</td> <td>1.000</td> <td>PZ</td> </tr> <tr> <td>VI1174A0</td> <td>VITE 5X20 PER PLASTICA ZN-NI</td> <td>16.000</td> <td>PZ</td> </tr> <tr> <td>VI1220A1</td> <td>VITE AUTOFIL. 4.2X11 TCS+ MARUTEX</td> <td>26.000</td> <td>PZ</td> </tr> <tr> <td>VI1996A0</td> <td>VITE M5x35 TCEI ZN</td> <td>13.000</td> <td>PZ</td> </tr> <tr> <td>VM1490A0</td> <td>COPRI VITI MANIGLIA CHEFTOP BAKERTOP</td> <td>2.000</td> <td>PZ</td> </tr> <tr> <td>VM1630A1</td> <td>TAPPO PREMI VETRO INTERNO</td> <td>3.000</td> <td>PZ</td> </tr> <tr> <td>VM1631A0</td> <td>TAPPO PREMI VETRO INTERNO PLU</td> <td>3.000</td> <td>PZ</td> </tr> <tr> <td>VM2259B0</td> <td>TAPPO INF SX PORTA S6</td> <td>1.000</td> <td>PZ</td> </tr> <tr> <td>VM2268A0</td> <td>TAPPO COPRI CALAMITA PORTA</td> <td>1.000</td> <td>PZ</td> </tr> <tr> <td>VM2274A0</td> <td>BOCCOLA SCANALATA CORTA</td> <td>1.000</td> <td>PZ</td> </tr> <tr> <td>VM2275A0</td> <td>BOCCOLA LISCIA CORTA</td> <td>1.000</td> <td>PZ</td> </tr> </tbody> </table>	Code	Description	Qty	UOM	MG1099A1	ASSIEME MANIGLIA COMPLETO MMc	1.000	PZ	SL1170A1	SILICONE ANTRACITE S57 CARTUCCIA 310 ml	30.000	ML	SL1221A0	SILICONE SUP VETRO EXT GN1/1	1.000	PZ	SL1222A0	SILICONE LAT VETRO EXT 0511	4.000	PZ	VE1030A1	CALAMITA D=22,9mm PER MICROPORTA	1.000	PZ	VI1034A0	RONDELLA PIANA 8.4x16x1 INOX	1.000	PZ	VI1074A0	VITE PER PLASTICA 4X16 TPBS+ INOX	1.000	PZ	VI1174A0	VITE 5X20 PER PLASTICA ZN-NI	16.000	PZ	VI1220A1	VITE AUTOFIL. 4.2X11 TCS+ MARUTEX	26.000	PZ	VI1996A0	VITE M5x35 TCEI ZN	13.000	PZ	VM1490A0	COPRI VITI MANIGLIA CHEFTOP BAKERTOP	2.000	PZ	VM1630A1	TAPPO PREMI VETRO INTERNO	3.000	PZ	VM1631A0	TAPPO PREMI VETRO INTERNO PLU	3.000	PZ	VM2259B0	TAPPO INF SX PORTA S6	1.000	PZ	VM2268A0	TAPPO COPRI CALAMITA PORTA	1.000	PZ	VM2274A0	BOCCOLA SCANALATA CORTA	1.000	PZ	VM2275A0	BOCCOLA LISCIA CORTA	1.000	PZ
Code	Description	Qty	UOM																																																																										
MG1099A1	ASSIEME MANIGLIA COMPLETO MMc	1.000	PZ																																																																										
SL1170A1	SILICONE ANTRACITE S57 CARTUCCIA 310 ml	30.000	ML																																																																										
SL1221A0	SILICONE SUP VETRO EXT GN1/1	1.000	PZ																																																																										
SL1222A0	SILICONE LAT VETRO EXT 0511	4.000	PZ																																																																										
VE1030A1	CALAMITA D=22,9mm PER MICROPORTA	1.000	PZ																																																																										
VI1034A0	RONDELLA PIANA 8.4x16x1 INOX	1.000	PZ																																																																										
VI1074A0	VITE PER PLASTICA 4X16 TPBS+ INOX	1.000	PZ																																																																										
VI1174A0	VITE 5X20 PER PLASTICA ZN-NI	16.000	PZ																																																																										
VI1220A1	VITE AUTOFIL. 4.2X11 TCS+ MARUTEX	26.000	PZ																																																																										
VI1996A0	VITE M5x35 TCEI ZN	13.000	PZ																																																																										
VM1490A0	COPRI VITI MANIGLIA CHEFTOP BAKERTOP	2.000	PZ																																																																										
VM1630A1	TAPPO PREMI VETRO INTERNO	3.000	PZ																																																																										
VM1631A0	TAPPO PREMI VETRO INTERNO PLU	3.000	PZ																																																																										
VM2259B0	TAPPO INF SX PORTA S6	1.000	PZ																																																																										
VM2268A0	TAPPO COPRI CALAMITA PORTA	1.000	PZ																																																																										
VM2274A0	BOCCOLA SCANALATA CORTA	1.000	PZ																																																																										
VM2275A0	BOCCOLA LISCIA CORTA	1.000	PZ																																																																										

COMPONENT			SPARE PART																																																																					
Code	Description	Image	Code	Description	Kit components																																																																			
0B1106A	COLONNINA ESTERNA SX PORTA XEVC-0511-E		KDR1261B	0511 -M RIGHT EXTERNAL DOOR	<table border="1"> <thead> <tr> <th>Code</th> <th>Description</th> <th>Qty</th> <th>UOM</th> </tr> </thead> <tbody> <tr> <td>VM2284B0</td> <td>PROFILO SALVAGOCCE SERIE 750</td> <td>1.000</td> <td>PZ</td> </tr> <tr> <td>VM2305A0</td> <td>NOTTOLINO FISSAGGIO TAPPI PORTE MM</td> <td>14.000</td> <td>PZ</td> </tr> <tr> <td>VM2312A0</td> <td>TUBETTO SX SCARICO GOCCIOLATOI O MM</td> <td>1.000</td> <td>PZ</td> </tr> <tr> <td>VM2314A0</td> <td>TAPPINO GOCCIOLATOI O MM</td> <td>1.000</td> <td>PZ</td> </tr> <tr> <td>VM2315B0</td> <td>SUPPORTO SPINGI VETRO INT MM -M</td> <td>3.000</td> <td>PZ</td> </tr> <tr> <td>VM2505B1</td> <td>SUPPORTO PREMI VETRO INT MM PLUS</td> <td>3.000</td> <td>PZ</td> </tr> <tr> <td>VM3008A0</td> <td>ASSEMBLATO TAPPO SUP DX PORTA MM -MV</td> <td>1.000</td> <td>PZ</td> </tr> <tr> <td>VM3010A0</td> <td>ASSEMBLATO TAPPO INF DX PORTA MM -M</td> <td>1.000</td> <td>PZ</td> </tr> <tr> <td>VM3011A0</td> <td>ASSEMBLATO TAPPO SUP SX PORTA S6 -MV</td> <td>1.000</td> <td>PZ</td> </tr> <tr> <td>VP1080A0</td> <td>TAPPO SUP CERNIERA VETRO INTERNO INF</td> <td>1.000</td> <td>PZ</td> </tr> <tr> <td>VT1276A0</td> <td>VETRO ESTERNO SER. XEVC-0511-E</td> <td>1.000</td> <td>PZ</td> </tr> </tbody> </table>	Code	Description	Qty	UOM	VM2284B0	PROFILO SALVAGOCCE SERIE 750	1.000	PZ	VM2305A0	NOTTOLINO FISSAGGIO TAPPI PORTE MM	14.000	PZ	VM2312A0	TUBETTO SX SCARICO GOCCIOLATOI O MM	1.000	PZ	VM2314A0	TAPPINO GOCCIOLATOI O MM	1.000	PZ	VM2315B0	SUPPORTO SPINGI VETRO INT MM -M	3.000	PZ	VM2505B1	SUPPORTO PREMI VETRO INT MM PLUS	3.000	PZ	VM3008A0	ASSEMBLATO TAPPO SUP DX PORTA MM -MV	1.000	PZ	VM3010A0	ASSEMBLATO TAPPO INF DX PORTA MM -M	1.000	PZ	VM3011A0	ASSEMBLATO TAPPO SUP SX PORTA S6 -MV	1.000	PZ	VP1080A0	TAPPO SUP CERNIERA VETRO INTERNO INF	1.000	PZ	VT1276A0	VETRO ESTERNO SER. XEVC-0511-E	1.000	PZ	KDR1261A	0511 RIGHT EXTERNAL DOOR	<table border="1"> <thead> <tr> <th>Code</th> <th>Description</th> <th>Qty</th> <th>UOM</th> </tr> </thead> <tbody> <tr> <td>0B1106A0</td> <td>COLONNINA ESTERNA SX PORTA XEVC-0511-E</td> <td>1.000</td> <td>PZ</td> </tr> <tr> <td>0B1107A1</td> <td>COLONNINA INTERNA SX PORTA XEVC-0511-E</td> <td>1.000</td> <td>PZ</td> </tr> <tr> <td>0B1108B1</td> <td>COLONNINA ESTERNA DX PORTA XEVC-0511</td> <td>1.000</td> <td>PZ</td> </tr> </tbody> </table>	Code	Description	Qty	UOM	0B1106A0	COLONNINA ESTERNA SX PORTA XEVC-0511-E	1.000	PZ	0B1107A1	COLONNINA INTERNA SX PORTA XEVC-0511-E	1.000	PZ	0B1108B1	COLONNINA ESTERNA DX PORTA XEVC-0511	1.000	PZ
			Code	Description	Qty	UOM																																																																		
VM2284B0	PROFILO SALVAGOCCE SERIE 750	1.000	PZ																																																																					
VM2305A0	NOTTOLINO FISSAGGIO TAPPI PORTE MM	14.000	PZ																																																																					
VM2312A0	TUBETTO SX SCARICO GOCCIOLATOI O MM	1.000	PZ																																																																					
VM2314A0	TAPPINO GOCCIOLATOI O MM	1.000	PZ																																																																					
VM2315B0	SUPPORTO SPINGI VETRO INT MM -M	3.000	PZ																																																																					
VM2505B1	SUPPORTO PREMI VETRO INT MM PLUS	3.000	PZ																																																																					
VM3008A0	ASSEMBLATO TAPPO SUP DX PORTA MM -MV	1.000	PZ																																																																					
VM3010A0	ASSEMBLATO TAPPO INF DX PORTA MM -M	1.000	PZ																																																																					
VM3011A0	ASSEMBLATO TAPPO SUP SX PORTA S6 -MV	1.000	PZ																																																																					
VP1080A0	TAPPO SUP CERNIERA VETRO INTERNO INF	1.000	PZ																																																																					
VT1276A0	VETRO ESTERNO SER. XEVC-0511-E	1.000	PZ																																																																					
Code	Description	Qty	UOM																																																																					
0B1106A0	COLONNINA ESTERNA SX PORTA XEVC-0511-E	1.000	PZ																																																																					
0B1107A1	COLONNINA INTERNA SX PORTA XEVC-0511-E	1.000	PZ																																																																					
0B1108B1	COLONNINA ESTERNA DX PORTA XEVC-0511	1.000	PZ																																																																					

COMPONENT			SPARE PART																																																														
Code	Description	Image	Code	Description	Kit components																																																												
OB1106A	COLONNINA ESTERNA SX PORTA XEVC-0511-E		KDR1261A	0511 RIGHT EXTERNAL DOOR	<table border="1"> <thead> <tr> <th>Code</th> <th>Description</th> <th>Qty</th> <th>UOM</th> </tr> </thead> <tbody> <tr> <td>OB1109A1</td> <td>COLONNINA INTERNA DX PORTA XEVC-0511-E</td> <td>1.000</td> <td>PZ</td> </tr> <tr> <td>OB1122A1</td> <td>TRAVERSO INFERIORE PORTA 750 S6</td> <td>1.000</td> <td>PZ</td> </tr> <tr> <td>OB1166A1</td> <td>PROFILO SUPPORTO VETRO EST XEVC-0511-E</td> <td>2.000</td> <td>PZ</td> </tr> <tr> <td>OB1216A1</td> <td>TRAVERSO SUPERIORE PORTA 750mm MM 2V</td> <td>1.000</td> <td>PZ</td> </tr> <tr> <td>OB1217A1</td> <td>TRAVERSO SUPERIORE INT PORTA 750 S6 2V</td> <td>1.000</td> <td>PZ</td> </tr> <tr> <td>CE1052A1</td> <td>CAVO CONNESSION E CONTROLLO- USB MM 750m</td> <td>1.000</td> <td>PZ</td> </tr> <tr> <td>CE1053B0</td> <td>CAVO ALIMENT BARRA LED MM MICROFIT 2P</td> <td>1.000</td> <td>PZ</td> </tr> <tr> <td>CE1275A0</td> <td>CAVO COLLEGAMEN TO POTENZA CONTROLLO 3 M</td> <td>1.000</td> <td>PZ</td> </tr> <tr> <td>CE1285A0</td> <td>FERRITE EMI ROUND MOD. 2643801502</td> <td>1.000</td> <td>PZ</td> </tr> <tr> <td>CE1290A0</td> <td>MORSETTO FEMMINA ESTRAIBILE CPF 5/4</td> <td>1.000</td> <td>PZ</td> </tr> <tr> <td>GN1525A0</td> <td>O-RING D.INT 9.5xSP 1 NBR 7</td> <td>1.000</td> <td>PZ</td> </tr> <tr> <td>LP1019A0</td> <td>BARRA ILLUMINAZION E LED MM L200 E415</td> <td>1.000</td> <td>PZ</td> </tr> <tr> <td>LP1025A0</td> <td>ESTRUSO ILLUMINAZION E NO LED MM L415</td> <td>1.000</td> <td>PZ</td> </tr> <tr> <td>MG1083A2</td> <td>ASSIEME MANIGLIA COMPLETO M</td> <td>1.000</td> <td>PZ</td> </tr> </tbody> </table>	Code	Description	Qty	UOM	OB1109A1	COLONNINA INTERNA DX PORTA XEVC-0511-E	1.000	PZ	OB1122A1	TRAVERSO INFERIORE PORTA 750 S6	1.000	PZ	OB1166A1	PROFILO SUPPORTO VETRO EST XEVC-0511-E	2.000	PZ	OB1216A1	TRAVERSO SUPERIORE PORTA 750mm MM 2V	1.000	PZ	OB1217A1	TRAVERSO SUPERIORE INT PORTA 750 S6 2V	1.000	PZ	CE1052A1	CAVO CONNESSION E CONTROLLO- USB MM 750m	1.000	PZ	CE1053B0	CAVO ALIMENT BARRA LED MM MICROFIT 2P	1.000	PZ	CE1275A0	CAVO COLLEGAMEN TO POTENZA CONTROLLO 3 M	1.000	PZ	CE1285A0	FERRITE EMI ROUND MOD. 2643801502	1.000	PZ	CE1290A0	MORSETTO FEMMINA ESTRAIBILE CPF 5/4	1.000	PZ	GN1525A0	O-RING D.INT 9.5xSP 1 NBR 7	1.000	PZ	LP1019A0	BARRA ILLUMINAZION E LED MM L200 E415	1.000	PZ	LP1025A0	ESTRUSO ILLUMINAZION E NO LED MM L415	1.000	PZ	MG1083A2	ASSIEME MANIGLIA COMPLETO M	1.000	PZ
					Code	Description	Qty	UOM																																																									
					OB1109A1	COLONNINA INTERNA DX PORTA XEVC-0511-E	1.000	PZ																																																									
					OB1122A1	TRAVERSO INFERIORE PORTA 750 S6	1.000	PZ																																																									
					OB1166A1	PROFILO SUPPORTO VETRO EST XEVC-0511-E	2.000	PZ																																																									
					OB1216A1	TRAVERSO SUPERIORE PORTA 750mm MM 2V	1.000	PZ																																																									
					OB1217A1	TRAVERSO SUPERIORE INT PORTA 750 S6 2V	1.000	PZ																																																									
					CE1052A1	CAVO CONNESSION E CONTROLLO- USB MM 750m	1.000	PZ																																																									
					CE1053B0	CAVO ALIMENT BARRA LED MM MICROFIT 2P	1.000	PZ																																																									
					CE1275A0	CAVO COLLEGAMEN TO POTENZA CONTROLLO 3 M	1.000	PZ																																																									
					CE1285A0	FERRITE EMI ROUND MOD. 2643801502	1.000	PZ																																																									
					CE1290A0	MORSETTO FEMMINA ESTRAIBILE CPF 5/4	1.000	PZ																																																									
					GN1525A0	O-RING D.INT 9.5xSP 1 NBR 7	1.000	PZ																																																									
					LP1019A0	BARRA ILLUMINAZION E LED MM L200 E415	1.000	PZ																																																									
LP1025A0	ESTRUSO ILLUMINAZION E NO LED MM L415	1.000	PZ																																																														
MG1083A2	ASSIEME MANIGLIA COMPLETO M	1.000	PZ																																																														

COMPONENT			SPARE PART																																																																														
Code	Description	Image	Code	Description	Kit components																																																																												
OB1106A	COLONNINA ESTERNA SX PORTA XEVC-0511-E		KDR1261A	0511 RIGHT EXTERNAL DOOR	<table border="1"> <thead> <tr> <th>Code</th> <th>Description</th> <th>Qty</th> <th>UOM</th> </tr> </thead> <tbody> <tr> <td>SL1170A1</td> <td>SILICONE ANTRACITE S57 CARTUCCIA 310 ml</td> <td>30.000</td> <td>ML</td> </tr> <tr> <td>VE1030A1</td> <td>CALAMITA D=22,9mm PER MICROPORTA</td> <td>1.000</td> <td>PZ</td> </tr> <tr> <td>VI1034A0</td> <td>RONDELLA PIANA 8.4x16x1 INOX</td> <td>1.000</td> <td>PZ</td> </tr> <tr> <td>VI1147A0</td> <td>VITE 5X25 TRUCIOLARE INOX</td> <td>16.000</td> <td>PZ</td> </tr> <tr> <td>VI1220A1</td> <td>VITE AUTOFIL. 4.2X11 TCS+ MARUTEX</td> <td>25.000</td> <td>PZ</td> </tr> <tr> <td>VI1996A0</td> <td>VITE M5x35 TCEI ZN</td> <td>13.000</td> <td>PZ</td> </tr> <tr> <td>VM1630A1</td> <td>TAPPO PREMI VETRO INTERNO</td> <td>3.000</td> <td>PZ</td> </tr> <tr> <td>VM1631A0</td> <td>TAPPO PREMI VETRO INTERNO PLU</td> <td>2.000</td> <td>PZ</td> </tr> <tr> <td>VM2259A1</td> <td>TAPPO INF SX PORTA S6</td> <td>1.000</td> <td>PZ</td> </tr> <tr> <td>VM2260A1</td> <td>TAPPO SUP SX PORTA S6</td> <td>1.000</td> <td>PZ</td> </tr> <tr> <td>VM2261A1</td> <td>TAPPO INF DX PORTA MM</td> <td>1.000</td> <td>PZ</td> </tr> <tr> <td>VM2262A1</td> <td>TAPPO SUP DX PORTA MM</td> <td>1.000</td> <td>PZ</td> </tr> <tr> <td>VM2267A1</td> <td>CORSOIO SISTEMA FERMA VETRO INT</td> <td>2.000</td> <td>PZ</td> </tr> <tr> <td>VM2268A0</td> <td>TAPPO COPRI CALAMITA PORTA</td> <td>2.000</td> <td>PZ</td> </tr> <tr> <td>VM2269A0</td> <td>TAPPO SISTEMA FERMA VETRO INT</td> <td>2.000</td> <td>PZ</td> </tr> <tr> <td>VM2274A0</td> <td>BOCCOLA SCANALATA CORTA</td> <td>1.000</td> <td>PZ</td> </tr> <tr> <td>VM2275A0</td> <td>BOCCOLA LISCIA CORTA</td> <td>1.000</td> <td>PZ</td> </tr> <tr> <td>VM2284A0</td> <td>PROFILO SALVAGOCCE SERIE 750</td> <td>1.000</td> <td>PZ</td> </tr> </tbody> </table>	Code	Description	Qty	UOM	SL1170A1	SILICONE ANTRACITE S57 CARTUCCIA 310 ml	30.000	ML	VE1030A1	CALAMITA D=22,9mm PER MICROPORTA	1.000	PZ	VI1034A0	RONDELLA PIANA 8.4x16x1 INOX	1.000	PZ	VI1147A0	VITE 5X25 TRUCIOLARE INOX	16.000	PZ	VI1220A1	VITE AUTOFIL. 4.2X11 TCS+ MARUTEX	25.000	PZ	VI1996A0	VITE M5x35 TCEI ZN	13.000	PZ	VM1630A1	TAPPO PREMI VETRO INTERNO	3.000	PZ	VM1631A0	TAPPO PREMI VETRO INTERNO PLU	2.000	PZ	VM2259A1	TAPPO INF SX PORTA S6	1.000	PZ	VM2260A1	TAPPO SUP SX PORTA S6	1.000	PZ	VM2261A1	TAPPO INF DX PORTA MM	1.000	PZ	VM2262A1	TAPPO SUP DX PORTA MM	1.000	PZ	VM2267A1	CORSOIO SISTEMA FERMA VETRO INT	2.000	PZ	VM2268A0	TAPPO COPRI CALAMITA PORTA	2.000	PZ	VM2269A0	TAPPO SISTEMA FERMA VETRO INT	2.000	PZ	VM2274A0	BOCCOLA SCANALATA CORTA	1.000	PZ	VM2275A0	BOCCOLA LISCIA CORTA	1.000	PZ	VM2284A0	PROFILO SALVAGOCCE SERIE 750	1.000	PZ
Code	Description	Qty	UOM																																																																														
SL1170A1	SILICONE ANTRACITE S57 CARTUCCIA 310 ml	30.000	ML																																																																														
VE1030A1	CALAMITA D=22,9mm PER MICROPORTA	1.000	PZ																																																																														
VI1034A0	RONDELLA PIANA 8.4x16x1 INOX	1.000	PZ																																																																														
VI1147A0	VITE 5X25 TRUCIOLARE INOX	16.000	PZ																																																																														
VI1220A1	VITE AUTOFIL. 4.2X11 TCS+ MARUTEX	25.000	PZ																																																																														
VI1996A0	VITE M5x35 TCEI ZN	13.000	PZ																																																																														
VM1630A1	TAPPO PREMI VETRO INTERNO	3.000	PZ																																																																														
VM1631A0	TAPPO PREMI VETRO INTERNO PLU	2.000	PZ																																																																														
VM2259A1	TAPPO INF SX PORTA S6	1.000	PZ																																																																														
VM2260A1	TAPPO SUP SX PORTA S6	1.000	PZ																																																																														
VM2261A1	TAPPO INF DX PORTA MM	1.000	PZ																																																																														
VM2262A1	TAPPO SUP DX PORTA MM	1.000	PZ																																																																														
VM2267A1	CORSOIO SISTEMA FERMA VETRO INT	2.000	PZ																																																																														
VM2268A0	TAPPO COPRI CALAMITA PORTA	2.000	PZ																																																																														
VM2269A0	TAPPO SISTEMA FERMA VETRO INT	2.000	PZ																																																																														
VM2274A0	BOCCOLA SCANALATA CORTA	1.000	PZ																																																																														
VM2275A0	BOCCOLA LISCIA CORTA	1.000	PZ																																																																														
VM2284A0	PROFILO SALVAGOCCE SERIE 750	1.000	PZ																																																																														

COMPONENT			SPARE PART																																						
Code	Description	Image	Code	Description	Kit components																																				
0B1106A	COLONNINA ESTERNA SX PORTA XEVC-0511-E		KDR1261A	0511 RIGHT EXTERNAL DOOR	<table border="1"> <thead> <tr> <th>Code</th> <th>Description</th> <th>Qty</th> <th>UOM</th> </tr> </thead> <tbody> <tr> <td>VM2305A0</td> <td>NOTTOLINO FISSAGGIO TAPPI PORTE MM</td> <td>14.000</td> <td>PZ</td> </tr> <tr> <td>VM2312A0</td> <td>TUBETTO SX SCARICO GOCCIOLATOI O MM</td> <td>1.000</td> <td>PZ</td> </tr> <tr> <td>VM2314A0</td> <td>TAPPINO GOCCIOLATOI O MM</td> <td>1.000</td> <td>PZ</td> </tr> <tr> <td>VM2315A0</td> <td>SUPPORTO SPINGI VETRO INT MM</td> <td>3.000</td> <td>PZ</td> </tr> <tr> <td>VM2505A0</td> <td>SUPPORTO PREMI VETRO INT MM PLUS</td> <td>2.000</td> <td>PZ</td> </tr> <tr> <td>VM2518A0</td> <td>SUPPORTO VENTOLA RAFF CRUS 20X20 H20</td> <td>1.000</td> <td>PZ</td> </tr> <tr> <td>VN1179A1</td> <td>VENTIL ASSIALE 40x40x20mm 12Vcc</td> <td>1.000</td> <td>PZ</td> </tr> <tr> <td>VT1276A0</td> <td>VETRO ESTERNO SER. XEVC-0511-E</td> <td>1.000</td> <td>PZ</td> </tr> </tbody> </table>	Code	Description	Qty	UOM	VM2305A0	NOTTOLINO FISSAGGIO TAPPI PORTE MM	14.000	PZ	VM2312A0	TUBETTO SX SCARICO GOCCIOLATOI O MM	1.000	PZ	VM2314A0	TAPPINO GOCCIOLATOI O MM	1.000	PZ	VM2315A0	SUPPORTO SPINGI VETRO INT MM	3.000	PZ	VM2505A0	SUPPORTO PREMI VETRO INT MM PLUS	2.000	PZ	VM2518A0	SUPPORTO VENTOLA RAFF CRUS 20X20 H20	1.000	PZ	VN1179A1	VENTIL ASSIALE 40x40x20mm 12Vcc	1.000	PZ	VT1276A0	VETRO ESTERNO SER. XEVC-0511-E	1.000	PZ
					Code	Description	Qty	UOM																																	
					VM2305A0	NOTTOLINO FISSAGGIO TAPPI PORTE MM	14.000	PZ																																	
					VM2312A0	TUBETTO SX SCARICO GOCCIOLATOI O MM	1.000	PZ																																	
					VM2314A0	TAPPINO GOCCIOLATOI O MM	1.000	PZ																																	
					VM2315A0	SUPPORTO SPINGI VETRO INT MM	3.000	PZ																																	
					VM2505A0	SUPPORTO PREMI VETRO INT MM PLUS	2.000	PZ																																	
					VM2518A0	SUPPORTO VENTOLA RAFF CRUS 20X20 H20	1.000	PZ																																	
					VN1179A1	VENTIL ASSIALE 40x40x20mm 12Vcc	1.000	PZ																																	
					VT1276A0	VETRO ESTERNO SER. XEVC-0511-E	1.000	PZ																																	
0B1107A	COLONNINA INTERNA SX PORTA XEVC-0511-E		KDR1325A	0511 ZERO RIGHT -M EXTERNAL DOOR	<table border="1"> <thead> <tr> <th>Code</th> <th>Description</th> <th>Qty</th> <th>UOM</th> </tr> </thead> <tbody> <tr> <td>0B1106A0</td> <td>COLONNINA ESTERNA SX PORTA XEVC-0511-E</td> <td>1.000</td> <td>PZ</td> </tr> <tr> <td>0B1107A1</td> <td>COLONNINA INTERNA SX PORTA XEVC-0511-E</td> <td>1.000</td> <td>PZ</td> </tr> <tr> <td>0B1108B1</td> <td>COLONNINA ESTERNA DX PORTA XEVC-0511</td> <td>1.000</td> <td>PZ</td> </tr> <tr> <td>0B1109A1</td> <td>COLONNINA INTERNA DX PORTA XEVC-0511-E</td> <td>1.000</td> <td>PZ</td> </tr> <tr> <td>0B1122B0</td> <td>TRAVERSO INFERIORE PORTA 750 MMc</td> <td>1.000</td> <td>PZ</td> </tr> <tr> <td>0B1166A1</td> <td>PROFILO SUPPORTO VETRO EST XEVC-0511-E</td> <td>2.000</td> <td>PZ</td> </tr> </tbody> </table>	Code	Description	Qty	UOM	0B1106A0	COLONNINA ESTERNA SX PORTA XEVC-0511-E	1.000	PZ	0B1107A1	COLONNINA INTERNA SX PORTA XEVC-0511-E	1.000	PZ	0B1108B1	COLONNINA ESTERNA DX PORTA XEVC-0511	1.000	PZ	0B1109A1	COLONNINA INTERNA DX PORTA XEVC-0511-E	1.000	PZ	0B1122B0	TRAVERSO INFERIORE PORTA 750 MMc	1.000	PZ	0B1166A1	PROFILO SUPPORTO VETRO EST XEVC-0511-E	2.000	PZ								
					Code	Description	Qty	UOM																																	
					0B1106A0	COLONNINA ESTERNA SX PORTA XEVC-0511-E	1.000	PZ																																	
					0B1107A1	COLONNINA INTERNA SX PORTA XEVC-0511-E	1.000	PZ																																	
					0B1108B1	COLONNINA ESTERNA DX PORTA XEVC-0511	1.000	PZ																																	
					0B1109A1	COLONNINA INTERNA DX PORTA XEVC-0511-E	1.000	PZ																																	
					0B1122B0	TRAVERSO INFERIORE PORTA 750 MMc	1.000	PZ																																	
					0B1166A1	PROFILO SUPPORTO VETRO EST XEVC-0511-E	2.000	PZ																																	

COMPONENT			SPARE PART					
Code	Description	Image	Code	Description	Kit components			
0B1107A	COLONNINA INTERNA SX PORTA XEVC-0511-E		KDR1325A	0511 ZERO RIGHT -M EXTERNAL DOOR	Code	Description	Qty	UOM
					0B1216B0	TRAVERSO SUPERIORE PORTA 750 2V MMc	1.000	PZ
					0B1217A1	TRAVERSO SUPERIORE INT PORTA 750 S6 2V	1.000	PZ
					0H2892A0	LAMIERINO TAPPO SUP BARRA LED	1.000	PZ
					0H2893A0	LAMIERINO TAPPO INF BARRA LED	1.000	PZ
					CE1096A0	CAVO BUS MICROFIT 4POLI 3 M	1.000	PZ
					CE1285A0	FERRITE EMI ROUND MOD. 2643801502	2.000	PZ
					CE1851A0	CAVO Y MICROFIT 2P M-F-F AWG22	1.000	PZ
					CE2001A0	CAVO MICROFIT 2PM-100-2PM 2AWG22	1.000	PZ
					CE2002A0	CAVO MICROFIT 2PM-100-AMP MODU2 2AWG22	1.000	PZ
					GN1525A0	O-RING D.INT 9.5xSP 1 NBR 7	1.000	PZ
					LP1019A0	BARRA ILLUMINAZIONE LED MM L200 E415	1.000	PZ
					MG1099A1	ASSIEME MANIGLIA COMPLETO MMc	1.000	PZ
					SL1170A1	SILICONE ANTRACITE S57 CARTUCCIA 310 ml	30.000	ML
					SL1221A0	SILICONE SUP VETRO EXT GN1/1	1.000	PZ
SL1222A0	SILICONE LAT VETRO EXT 0511	4.000	PZ					

COMPONENT			SPARE PART					
Code	Description	Image	Code	Description	Kit components			
0B1107A	COLONNINA INTERNA SX PORTA XEVC-0511-E		KDR1325A	0511 ZERO RIGHT -M EXTERNAL DOOR	Code	Description	Qty	UOM
					VE1030A1	CALAMITA D=22,9mm PER MICROPORTA	1.000	PZ
					VI1034A0	RONDELLA PIANA 8,4x16x1 INOX	1.000	PZ
					VI1074A0	VITE PER PLASTICA 4X16 TPBS+ INOX	1.000	PZ
					VI1174A0	VITE 5X20 PER PLASTICA ZN-NI	16.000	PZ
					VI1220A1	VITE AUTOFIL. 4,2X11 TCS+ MARUTEX	26.000	PZ
					VI1996A0	VITE M5x35 TCEI ZN	13.000	PZ
					VM1490A0	COPRI VITI MANIGLIA CHEFTOP BAKERTOP	2.000	PZ
					VM1630A1	TAPPO PREMI VETRO INTERNO	3.000	PZ
					VM1631A0	TAPPO PREMI VETRO INTERNO PLU	3.000	PZ
					VM2259B0	TAPPO INF SX PORTA S6	1.000	PZ
					VM2268A0	TAPPO COPRI CALAMITA PORTA	1.000	PZ
					VM2274A0	BOCCOLA SCANALATA CORTA	1.000	PZ
					VM2275A0	BOCCOLA LISCIA CORTA	1.000	PZ
					VM2284B0	PROFILO SALVAGOCCE SERIE 750	1.000	PZ
					VM2305A0	NOTTOLINO FISSAGGIO TAPPI PORTE MM	14.000	PZ
					VM2312A0	TUBETTO SX SCARICO GOCCIOLATOI O MM	1.000	PZ
					VM2314A0	TAPPINO GOCCIOLATOI O MM	1.000	PZ
					VM2315B0	SUPPORTO SPINGI VETRO INT MM -M	3.000	PZ





COMPONENT			SPARE PART																																			
Code	Description	Image	Code	Description	Kit components																																	
0B1107A	COLONNINA INTERNA SX PORTA XEVC-0511-E		KDR1325A	0511 ZERO RIGHT -M EXTERNAL DOOR	<table border="1"> <thead> <tr> <th>Code</th> <th>Description</th> <th>Qty</th> <th>UOM</th> </tr> </thead> <tbody> <tr> <td>VM2505B1</td> <td>SUPPORTO PREMI VETRO INT MM PLUS</td> <td>3.000</td> <td>PZ</td> </tr> <tr> <td>VM2956A0</td> <td>ASSEMBLATO TAPPO SUP DX PORTA MM -M</td> <td>1.000</td> <td>PZ</td> </tr> <tr> <td>VM2957A0</td> <td>ASSEMBLATO TAPPO INF DX PORTA MM -M</td> <td>1.000</td> <td>PZ</td> </tr> <tr> <td>VM2958A0</td> <td>ASSEMBLATO TAPPO SUP SX PORTA MM -M</td> <td>1.000</td> <td>PZ</td> </tr> <tr> <td>VP1080A0</td> <td>TAPPO SUP CERNIERA VETRO INTERNO INF</td> <td>1.000</td> <td>PZ</td> </tr> <tr> <td>VT1276A0</td> <td>VETRO ESTERNO SER. XEVC-0511-E</td> <td>1.000</td> <td>PZ</td> </tr> </tbody> </table>	Code	Description	Qty	UOM	VM2505B1	SUPPORTO PREMI VETRO INT MM PLUS	3.000	PZ	VM2956A0	ASSEMBLATO TAPPO SUP DX PORTA MM -M	1.000	PZ	VM2957A0	ASSEMBLATO TAPPO INF DX PORTA MM -M	1.000	PZ	VM2958A0	ASSEMBLATO TAPPO SUP SX PORTA MM -M	1.000	PZ	VP1080A0	TAPPO SUP CERNIERA VETRO INTERNO INF	1.000	PZ	VT1276A0	VETRO ESTERNO SER. XEVC-0511-E	1.000	PZ					
			Code	Description	Qty	UOM																																
VM2505B1	SUPPORTO PREMI VETRO INT MM PLUS	3.000	PZ																																			
VM2956A0	ASSEMBLATO TAPPO SUP DX PORTA MM -M	1.000	PZ																																			
VM2957A0	ASSEMBLATO TAPPO INF DX PORTA MM -M	1.000	PZ																																			
VM2958A0	ASSEMBLATO TAPPO SUP SX PORTA MM -M	1.000	PZ																																			
VP1080A0	TAPPO SUP CERNIERA VETRO INTERNO INF	1.000	PZ																																			
VT1276A0	VETRO ESTERNO SER. XEVC-0511-E	1.000	PZ																																			
KDR1269B	BT-04 -M EXTERNAL RIGHT DOOR	<table border="1"> <thead> <tr> <th>Code</th> <th>Description</th> <th>Qty</th> <th>UOM</th> </tr> </thead> <tbody> <tr> <td>0B1107A1</td> <td>COLONNINA INTERNA SX PORTA XEVC-0511-E</td> <td>1.000</td> <td>PZ</td> </tr> <tr> <td>0B1108B1</td> <td>COLONNINA ESTERNA DX PORTA XEVC-0511</td> <td>1.000</td> <td>PZ</td> </tr> <tr> <td>0B1109A1</td> <td>COLONNINA INTERNA DX PORTA XEVC-0511-E</td> <td>1.000</td> <td>PZ</td> </tr> <tr> <td>0B1126B0</td> <td>TRAVERSO INFERIORE PORTA 860 M</td> <td>1.000</td> <td>PZ</td> </tr> <tr> <td>0B1166A1</td> <td>PROFILO SUPPORTO VETRO EST XEVC-0511-E</td> <td>2.000</td> <td>PZ</td> </tr> <tr> <td>0B1174A0</td> <td>COLONNINA ESTERNA SX PORTA XEBC-04EU-E</td> <td>1.000</td> <td>PZ</td> </tr> <tr> <td>0B1218B0</td> <td>TRAVERSO SUPERIORE PORTA 860 2V MMc</td> <td>1.000</td> <td>PZ</td> </tr> <tr> <td>0B1219A1</td> <td>TRAVERSO SUPERIORE INT PORTA 860 S6 2V</td> <td>1.000</td> <td>PZ</td> </tr> </tbody> </table>	Code	Description	Qty	UOM	0B1107A1	COLONNINA INTERNA SX PORTA XEVC-0511-E	1.000	PZ	0B1108B1	COLONNINA ESTERNA DX PORTA XEVC-0511	1.000	PZ	0B1109A1	COLONNINA INTERNA DX PORTA XEVC-0511-E	1.000	PZ	0B1126B0	TRAVERSO INFERIORE PORTA 860 M	1.000	PZ	0B1166A1	PROFILO SUPPORTO VETRO EST XEVC-0511-E	2.000	PZ	0B1174A0	COLONNINA ESTERNA SX PORTA XEBC-04EU-E	1.000	PZ	0B1218B0	TRAVERSO SUPERIORE PORTA 860 2V MMc	1.000	PZ	0B1219A1	TRAVERSO SUPERIORE INT PORTA 860 S6 2V	1.000	PZ
Code	Description	Qty	UOM																																			
0B1107A1	COLONNINA INTERNA SX PORTA XEVC-0511-E	1.000	PZ																																			
0B1108B1	COLONNINA ESTERNA DX PORTA XEVC-0511	1.000	PZ																																			
0B1109A1	COLONNINA INTERNA DX PORTA XEVC-0511-E	1.000	PZ																																			
0B1126B0	TRAVERSO INFERIORE PORTA 860 M	1.000	PZ																																			
0B1166A1	PROFILO SUPPORTO VETRO EST XEVC-0511-E	2.000	PZ																																			
0B1174A0	COLONNINA ESTERNA SX PORTA XEBC-04EU-E	1.000	PZ																																			
0B1218B0	TRAVERSO SUPERIORE PORTA 860 2V MMc	1.000	PZ																																			
0B1219A1	TRAVERSO SUPERIORE INT PORTA 860 S6 2V	1.000	PZ																																			

COMPONENT			SPARE PART					
Code	Description	Image	Code	Description	Kit components			
OB1107A	COLONNINA INTERNA SX PORTA XEVC-0511-E		KDR1269B	BT-04 -M EXTERNAL RIGHT DOOR	Code	Description	Qty	UOM
					CE1052A1	CAVO CONNESSION E CONTROLLO- USB MM 750m	1.000	PZ
					CE1053B0	CAVO ALIMENT BARRA LED MM MICROFIT 2P	1.000	PZ
					CE1097A0	CAVO BUS MICROFIT 4 POLI SIHF 4M	1.000	PZ
					CE1285A0	FERRITE EMI ROUND MOD. 2643801502	2.000	PZ
					LP1019A0	BARRA ILLUMINAZION E LED MM L200 E415	1.000	PZ
					LP1025A0	ESTRUSO ILLUMINAZION E NO LED MM L415	1.000	PZ
					MG1099A1	ASSIEME MANIGLIA COMPLETO MMc	1.000	PZ
					SL1170A1	SILICONE ANTRACITE S57 CARTUCCIA 310 ml	35.000	ML
					SL1222A0	SILICONE LAT VETRO EXT 0511	4.000	PZ
					SL1229A0	SILICONE SUP VETRO EXT BAKER	1.000	PZ
					VE1030A1	CALAMITA D=22,9mm PER MICROPORTA	1.000	PZ
					VI1074A0	VITE PER PLASTICA 4X16 TPBS+ INOX	4.000	PZ
					VI1103A0	VITE PER PLASTICA 4X12 TPBS+ ZN-NI	2.000	PZ
					VI1174A0	VITE 5X20 PER PLASTICA ZN-NI	16.000	PZ

COMPONENT			SPARE PART																																																																										
Code	Description	Image	Code	Description	Kit components																																																																								
OB1107A	COLONNINA INTERNA SX PORTA XEVC-0511-E		KDR1269B	BT-04 -M EXTERNAL RIGHT DOOR	<table border="1"> <thead> <tr> <th>Code</th> <th>Description</th> <th>Qty</th> <th>UOM</th> </tr> </thead> <tbody> <tr> <td>VI1220A1</td> <td>VITE AUTOFIL 4.2X11 TCS+ MARUTEX</td> <td>28.000</td> <td>PZ</td> </tr> <tr> <td>VI1996A0</td> <td>VITE M5x35 TCEI ZN</td> <td>13.000</td> <td>PZ</td> </tr> <tr> <td>VM1490A0</td> <td>COPRI VITI MANIGLIA CHEFTOP BAKERTOP</td> <td>2.000</td> <td>PZ</td> </tr> <tr> <td>VM1630A1</td> <td>TAPPO PREMI VETRO INTERNO</td> <td>3.000</td> <td>PZ</td> </tr> <tr> <td>VM1631A0</td> <td>TAPPO PREMI VETRO INTERNO PLU</td> <td>3.000</td> <td>PZ</td> </tr> <tr> <td>VM2259B0</td> <td>TAPPO INF SX PORTA S6</td> <td>1.000</td> <td>PZ</td> </tr> <tr> <td>VM2268A0</td> <td>TAPPO COPRI CALAMITA PORTA</td> <td>1.000</td> <td>PZ</td> </tr> <tr> <td>VM2274A0</td> <td>BOCCOLA SCANALATA CORTA</td> <td>1.000</td> <td>PZ</td> </tr> <tr> <td>VM2275A0</td> <td>BOCCOLA LISCIA CORTA</td> <td>1.000</td> <td>PZ</td> </tr> <tr> <td>VM2285B0</td> <td>PROFILO SALVAGOCCE SERIE 860</td> <td>1.000</td> <td>PZ</td> </tr> <tr> <td>VM2305A0</td> <td>NOTTOLINO FISSAGGIO TAPPI PORTE MM</td> <td>14.000</td> <td>PZ</td> </tr> <tr> <td>VM2312A0</td> <td>TUBETTO SX SCARICO GOCCIOLATOI O MM</td> <td>1.000</td> <td>PZ</td> </tr> <tr> <td>VM2314A0</td> <td>TAPPINO GOCCIOLATOI O MM</td> <td>1.000</td> <td>PZ</td> </tr> <tr> <td>VM2315B0</td> <td>SUPPORTO SPINGI VETRO INT MM -M</td> <td>3.000</td> <td>PZ</td> </tr> <tr> <td>VM2505B1</td> <td>SUPPORTO PREMI VETRO INT MM PLUS</td> <td>3.000</td> <td>PZ</td> </tr> <tr> <td>VM2518A0</td> <td>SUPPORTO VENTOLA RAFF CRUS 20X20 H20</td> <td>1.000</td> <td>PZ</td> </tr> <tr> <td>VM3008A0</td> <td>ASSEMBLATO TAPPO SUP DX PORTA MM -MV</td> <td>1.000</td> <td>PZ</td> </tr> </tbody> </table>	Code	Description	Qty	UOM	VI1220A1	VITE AUTOFIL 4.2X11 TCS+ MARUTEX	28.000	PZ	VI1996A0	VITE M5x35 TCEI ZN	13.000	PZ	VM1490A0	COPRI VITI MANIGLIA CHEFTOP BAKERTOP	2.000	PZ	VM1630A1	TAPPO PREMI VETRO INTERNO	3.000	PZ	VM1631A0	TAPPO PREMI VETRO INTERNO PLU	3.000	PZ	VM2259B0	TAPPO INF SX PORTA S6	1.000	PZ	VM2268A0	TAPPO COPRI CALAMITA PORTA	1.000	PZ	VM2274A0	BOCCOLA SCANALATA CORTA	1.000	PZ	VM2275A0	BOCCOLA LISCIA CORTA	1.000	PZ	VM2285B0	PROFILO SALVAGOCCE SERIE 860	1.000	PZ	VM2305A0	NOTTOLINO FISSAGGIO TAPPI PORTE MM	14.000	PZ	VM2312A0	TUBETTO SX SCARICO GOCCIOLATOI O MM	1.000	PZ	VM2314A0	TAPPINO GOCCIOLATOI O MM	1.000	PZ	VM2315B0	SUPPORTO SPINGI VETRO INT MM -M	3.000	PZ	VM2505B1	SUPPORTO PREMI VETRO INT MM PLUS	3.000	PZ	VM2518A0	SUPPORTO VENTOLA RAFF CRUS 20X20 H20	1.000	PZ	VM3008A0	ASSEMBLATO TAPPO SUP DX PORTA MM -MV	1.000	PZ
					Code	Description	Qty	UOM																																																																					
					VI1220A1	VITE AUTOFIL 4.2X11 TCS+ MARUTEX	28.000	PZ																																																																					
					VI1996A0	VITE M5x35 TCEI ZN	13.000	PZ																																																																					
					VM1490A0	COPRI VITI MANIGLIA CHEFTOP BAKERTOP	2.000	PZ																																																																					
					VM1630A1	TAPPO PREMI VETRO INTERNO	3.000	PZ																																																																					
					VM1631A0	TAPPO PREMI VETRO INTERNO PLU	3.000	PZ																																																																					
					VM2259B0	TAPPO INF SX PORTA S6	1.000	PZ																																																																					
					VM2268A0	TAPPO COPRI CALAMITA PORTA	1.000	PZ																																																																					
					VM2274A0	BOCCOLA SCANALATA CORTA	1.000	PZ																																																																					
					VM2275A0	BOCCOLA LISCIA CORTA	1.000	PZ																																																																					
					VM2285B0	PROFILO SALVAGOCCE SERIE 860	1.000	PZ																																																																					
					VM2305A0	NOTTOLINO FISSAGGIO TAPPI PORTE MM	14.000	PZ																																																																					
					VM2312A0	TUBETTO SX SCARICO GOCCIOLATOI O MM	1.000	PZ																																																																					
					VM2314A0	TAPPINO GOCCIOLATOI O MM	1.000	PZ																																																																					
					VM2315B0	SUPPORTO SPINGI VETRO INT MM -M	3.000	PZ																																																																					
					VM2505B1	SUPPORTO PREMI VETRO INT MM PLUS	3.000	PZ																																																																					
					VM2518A0	SUPPORTO VENTOLA RAFF CRUS 20X20 H20	1.000	PZ																																																																					
					VM3008A0	ASSEMBLATO TAPPO SUP DX PORTA MM -MV	1.000	PZ																																																																					

COMPONENT			SPARE PART																																			
Code	Description	Image	Code	Description	Kit components																																	
0B1107A	COLONNINA INTERNA SX PORTA XEVC-0511-E		KDR1269B	BT-04 -M EXTERNAL RIGHT DOOR	<table border="1"> <thead> <tr> <th>Code</th> <th>Description</th> <th>Qty</th> <th>UOM</th> </tr> </thead> <tbody> <tr> <td>VM3010A0</td> <td>ASSEMBLATO TAPPO INF DX PORTA MM -M</td> <td>1.000</td> <td>PZ</td> </tr> <tr> <td>VM3011A0</td> <td>ASSEMBLATO TAPPO SUP SX PORTA S6 -MV</td> <td>1.000</td> <td>PZ</td> </tr> <tr> <td>VN1179A1</td> <td>VENTIL ASSIALE 40x40x20mm 12Vcc</td> <td>1.000</td> <td>PZ</td> </tr> <tr> <td>VP1080A0</td> <td>TAPPO SUP CERNIERA VETRO INTERNO INF</td> <td>1.000</td> <td>PZ</td> </tr> <tr> <td>VT1290A0</td> <td>VETRO EST. SER. XEBC-04EU-E</td> <td>1.000</td> <td>PZ</td> </tr> </tbody> </table>	Code	Description	Qty	UOM	VM3010A0	ASSEMBLATO TAPPO INF DX PORTA MM -M	1.000	PZ	VM3011A0	ASSEMBLATO TAPPO SUP SX PORTA S6 -MV	1.000	PZ	VN1179A1	VENTIL ASSIALE 40x40x20mm 12Vcc	1.000	PZ	VP1080A0	TAPPO SUP CERNIERA VETRO INTERNO INF	1.000	PZ	VT1290A0	VETRO EST. SER. XEBC-04EU-E	1.000	PZ									
			Code	Description	Qty	UOM																																
VM3010A0	ASSEMBLATO TAPPO INF DX PORTA MM -M	1.000	PZ																																			
VM3011A0	ASSEMBLATO TAPPO SUP SX PORTA S6 -MV	1.000	PZ																																			
VN1179A1	VENTIL ASSIALE 40x40x20mm 12Vcc	1.000	PZ																																			
VP1080A0	TAPPO SUP CERNIERA VETRO INTERNO INF	1.000	PZ																																			
VT1290A0	VETRO EST. SER. XEBC-04EU-E	1.000	PZ																																			
KDR1269A	BT-04 EXTERNAL RIGHT DOOR	<table border="1"> <thead> <tr> <th>Code</th> <th>Description</th> <th>Qty</th> <th>UOM</th> </tr> </thead> <tbody> <tr> <td>0B1107A1</td> <td>COLONNINA INTERNA SX PORTA XEVC-0511-E</td> <td>1.000</td> <td>PZ</td> </tr> <tr> <td>0B1108B1</td> <td>COLONNINA ESTERNA DX PORTA XEVC-0511</td> <td>1.000</td> <td>PZ</td> </tr> <tr> <td>0B1109A1</td> <td>COLONNINA INTERNA DX PORTA XEVC-0511-E</td> <td>1.000</td> <td>PZ</td> </tr> <tr> <td>0B1126A1</td> <td>TRAVERSO INFERIORE PORTA 860 M</td> <td>1.000</td> <td>PZ</td> </tr> <tr> <td>0B1166A1</td> <td>PROFILO SUPPORTO VETRO EST XEVC-0511-E</td> <td>2.000</td> <td>PZ</td> </tr> <tr> <td>0B1174A0</td> <td>COLONNINA ESTERNA SX PORTA XEBC-04EU-E</td> <td>1.000</td> <td>PZ</td> </tr> <tr> <td>0B1218A1</td> <td>TRAVERSO SUPERIORE PORTA 860 MM 2V</td> <td>1.000</td> <td>PZ</td> </tr> <tr> <td>0B1219A1</td> <td>TRAVERSO SUPERIORE INT PORTA 860 S6 2V</td> <td>1.000</td> <td>PZ</td> </tr> </tbody> </table>	Code	Description	Qty	UOM	0B1107A1	COLONNINA INTERNA SX PORTA XEVC-0511-E	1.000	PZ	0B1108B1	COLONNINA ESTERNA DX PORTA XEVC-0511	1.000	PZ	0B1109A1	COLONNINA INTERNA DX PORTA XEVC-0511-E	1.000	PZ	0B1126A1	TRAVERSO INFERIORE PORTA 860 M	1.000	PZ	0B1166A1	PROFILO SUPPORTO VETRO EST XEVC-0511-E	2.000	PZ	0B1174A0	COLONNINA ESTERNA SX PORTA XEBC-04EU-E	1.000	PZ	0B1218A1	TRAVERSO SUPERIORE PORTA 860 MM 2V	1.000	PZ	0B1219A1	TRAVERSO SUPERIORE INT PORTA 860 S6 2V	1.000	PZ
Code	Description	Qty	UOM																																			
0B1107A1	COLONNINA INTERNA SX PORTA XEVC-0511-E	1.000	PZ																																			
0B1108B1	COLONNINA ESTERNA DX PORTA XEVC-0511	1.000	PZ																																			
0B1109A1	COLONNINA INTERNA DX PORTA XEVC-0511-E	1.000	PZ																																			
0B1126A1	TRAVERSO INFERIORE PORTA 860 M	1.000	PZ																																			
0B1166A1	PROFILO SUPPORTO VETRO EST XEVC-0511-E	2.000	PZ																																			
0B1174A0	COLONNINA ESTERNA SX PORTA XEBC-04EU-E	1.000	PZ																																			
0B1218A1	TRAVERSO SUPERIORE PORTA 860 MM 2V	1.000	PZ																																			
0B1219A1	TRAVERSO SUPERIORE INT PORTA 860 S6 2V	1.000	PZ																																			

COMPONENT			SPARE PART					
Code	Description	Image	Code	Description	Kit components			
0B1107A	COLONNINA INTERNA SX PORTA XEVC-0511-E		KDR1269A	BT-04 EXTERNAL RIGHT DOOR	Code	Description	Qty	UOM
					CE1052A1	CAVO CONNESSION E CONTROLLO- USB MM 750m	1.000	PZ
					CE1053B0	CAVO ALIMENT BARRA LED MM MICROFIT 2P	1.000	PZ
					CE1285A0	FERRITE EMI ROUND MOD. 2643801502	1.000	PZ
					CE1290A0	MORSETTO FEMMINA ESTRAIBILE CPF 5/4	1.000	PZ
					CE1310A1	CAVO COLLEGAMEN TO POTENZA CONTROLLO L4 M	1.000	PZ
					LP1019A0	BARRA ILLUMINAZION E LED MM L200 E415	1.000	PZ
					LP1025A0	ESTRUSO ILLUMINAZION E NO LED MM L415	1.000	PZ
					MG1083A2	ASSIEME MANIGLIA COMPLETO M	1.000	PZ
					SL1170A1	SILICONE ANTRACITE S57 CARTUCCIA 310 ml	30.000	ML
					VE1030A1	CALAMITA D=22,9mm PER MICROPORTA	1.000	PZ
					VI1147A0	VITE 5X25 TRUCIOLARE INOX	16.000	PZ
					VI1220A1	VITE AUTOFIL. 4.2X11 TCS+ MARUTEX	25.000	PZ
					VI1996A0	VITE M5x35 TCEI ZN	13.000	PZ
					VM1630A1	TAPPO PREMI VETRO INTERNO	3.000	PZ
VM1631A0	TAPPO PREMI VETRO INTERNO PLU	2.000	PZ					

COMPONENT			SPARE PART					
Code	Description	Image	Code	Description	Kit components			
OB1107A	COLONNINA INTERNA SX PORTA XEVC-0511-E		KDR1269A	BT-04 EXTERNAL RIGHT DOOR	Code	Description	Qty	UOM
					VM2259A1	TAPPO INF SX PORTA S6	1.000	PZ
					VM2260A1	TAPPO SUP SX PORTA S6	1.000	PZ
					VM2261A1	TAPPO INF DX PORTA MM	1.000	PZ
					VM2262A1	TAPPO SUP DX PORTA MM	1.000	PZ
					VM2267A1	CORSOIO SISTEMA FERMA VETRO INT	2.000	PZ
					VM2268A0	TAPPO COPRI CALAMITA PORTA	2.000	PZ
					VM2269A0	TAPPO SISTEMA FERMA VETRO INT	2.000	PZ
					VM2274A0	BOCCOLA SCANALATA CORTA	1.000	PZ
					VM2275A0	BOCCOLA LISCIA CORTA	1.000	PZ
					VM2285A0	PROFILO SALVAGOCCE SERIE 860	1.000	PZ
					VM2305A0	NOTTOLINO FISSAGGIO TAPPI PORTE MM	14.000	PZ
					VM2312A0	TUBETTO SX SCARICO GOCCIOLATOI O MM	1.000	PZ
					VM2313A0	TUBETTO DX SCARICO GOCCIOLATOI O MM	1.000	PZ
					VM2314A0	TAPPINO GOCCIOLATOI O MM	1.000	PZ
					VM2315A0	SUPPORTO SPINGI VETRO INT MM	3.000	PZ
					VM2505A0	SUPPORTO PREMI VETRO INT MM PLUS	2.000	PZ
					VM2518A0	SUPPORTO VENTOLA RAFF CRUS 20X20 H20	1.000	PZ

COMPONENT			SPARE PART																																															
Code	Description	Image	Code	Description	Kit components																																													
0B1107A	COLONNINA INTERNA SX PORTA XEVC-0511-E		KDR1269A	BT-04 EXTERNAL RIGHT DOOR	<table border="1"> <thead> <tr> <th>Code</th> <th>Description</th> <th>Qty</th> <th>UOM</th> </tr> </thead> <tbody> <tr> <td>VN1179A1</td> <td>VENTIL ASSIALE 40x40x20mm 12Vcc</td> <td>1.000</td> <td>PZ</td> </tr> <tr> <td>VT1290A0</td> <td>VETRO EST. SER. XEBC-04EU-E</td> <td>1.000</td> <td>PZ</td> </tr> </tbody> </table>	Code	Description	Qty	UOM	VN1179A1	VENTIL ASSIALE 40x40x20mm 12Vcc	1.000	PZ	VT1290A0	VETRO EST. SER. XEBC-04EU-E	1.000	PZ																																	
			Code	Description	Qty	UOM																																												
VN1179A1	VENTIL ASSIALE 40x40x20mm 12Vcc	1.000	PZ																																															
VT1290A0	VETRO EST. SER. XEBC-04EU-E	1.000	PZ																																															
KDR1261B	0511 -M RIGHT EXTERNAL DOOR	<table border="1"> <thead> <tr> <th>Code</th> <th>Description</th> <th>Qty</th> <th>UOM</th> </tr> </thead> <tbody> <tr> <td>0B1106A0</td> <td>COLONNINA ESTERNA SX PORTA XEVC-0511-E</td> <td>1.000</td> <td>PZ</td> </tr> <tr> <td>0B1107A1</td> <td>COLONNINA INTERNA SX PORTA XEVC-0511-E</td> <td>1.000</td> <td>PZ</td> </tr> <tr> <td>0B1108B1</td> <td>COLONNINA ESTERNA DX PORTA XEVC-0511</td> <td>1.000</td> <td>PZ</td> </tr> <tr> <td>0B1109A1</td> <td>COLONNINA INTERNA DX PORTA XEVC-0511-E</td> <td>1.000</td> <td>PZ</td> </tr> <tr> <td>0B1122B0</td> <td>TRAVERSO INFERIORE PORTA 750 MMc</td> <td>1.000</td> <td>PZ</td> </tr> <tr> <td>0B1166A1</td> <td>PROFILO SUPPORTO VETRO EST XEVC-0511-E</td> <td>2.000</td> <td>PZ</td> </tr> <tr> <td>0B1216B0</td> <td>TRAVERSO SUPERIORE PORTA 750 2V MMc</td> <td>1.000</td> <td>PZ</td> </tr> <tr> <td>0B1217A1</td> <td>TRAVERSO SUPERIORE INT PORTA 750 S6 2V</td> <td>1.000</td> <td>PZ</td> </tr> <tr> <td>CE1052A1</td> <td>CAVO CONNESSIONE CONTROLLO- USB MM 750m</td> <td>1.000</td> <td>PZ</td> </tr> <tr> <td>CE1053B0</td> <td>CAVO ALIMENT BARRA LED MM MICROFIT 2P</td> <td>1.000</td> <td>PZ</td> </tr> <tr> <td>CE1096A0</td> <td>CAVO BUS MICROFIT 4POLI 3 M</td> <td>1.000</td> <td>PZ</td> </tr> </tbody> </table>	Code	Description	Qty	UOM	0B1106A0	COLONNINA ESTERNA SX PORTA XEVC-0511-E	1.000	PZ	0B1107A1	COLONNINA INTERNA SX PORTA XEVC-0511-E	1.000	PZ	0B1108B1	COLONNINA ESTERNA DX PORTA XEVC-0511	1.000	PZ	0B1109A1	COLONNINA INTERNA DX PORTA XEVC-0511-E	1.000	PZ	0B1122B0	TRAVERSO INFERIORE PORTA 750 MMc	1.000	PZ	0B1166A1	PROFILO SUPPORTO VETRO EST XEVC-0511-E	2.000	PZ	0B1216B0	TRAVERSO SUPERIORE PORTA 750 2V MMc	1.000	PZ	0B1217A1	TRAVERSO SUPERIORE INT PORTA 750 S6 2V	1.000	PZ	CE1052A1	CAVO CONNESSIONE CONTROLLO- USB MM 750m	1.000	PZ	CE1053B0	CAVO ALIMENT BARRA LED MM MICROFIT 2P	1.000	PZ	CE1096A0	CAVO BUS MICROFIT 4POLI 3 M	1.000	PZ
Code	Description	Qty	UOM																																															
0B1106A0	COLONNINA ESTERNA SX PORTA XEVC-0511-E	1.000	PZ																																															
0B1107A1	COLONNINA INTERNA SX PORTA XEVC-0511-E	1.000	PZ																																															
0B1108B1	COLONNINA ESTERNA DX PORTA XEVC-0511	1.000	PZ																																															
0B1109A1	COLONNINA INTERNA DX PORTA XEVC-0511-E	1.000	PZ																																															
0B1122B0	TRAVERSO INFERIORE PORTA 750 MMc	1.000	PZ																																															
0B1166A1	PROFILO SUPPORTO VETRO EST XEVC-0511-E	2.000	PZ																																															
0B1216B0	TRAVERSO SUPERIORE PORTA 750 2V MMc	1.000	PZ																																															
0B1217A1	TRAVERSO SUPERIORE INT PORTA 750 S6 2V	1.000	PZ																																															
CE1052A1	CAVO CONNESSIONE CONTROLLO- USB MM 750m	1.000	PZ																																															
CE1053B0	CAVO ALIMENT BARRA LED MM MICROFIT 2P	1.000	PZ																																															
CE1096A0	CAVO BUS MICROFIT 4POLI 3 M	1.000	PZ																																															



COMPONENT			SPARE PART					
Code	Description	Image	Code	Description	Kit components			
0B1107A	COLONNINA INTERNA SX PORTA XEVC-0511-E		KDR1261B	0511 -M RIGHT EXTERNAL DOOR	Code	Description	Qty	UOM
					CE1285A0	FERRITE EMI ROUND MOD. 2643801502	2.000	PZ
					GN1525A0	O-RING D.INT 9.5xSP 1 NBR 7	1.000	PZ
					LP1019A0	BARRA ILLUMINAZION E LED MM L200 E415	1.000	PZ
					LP1025A0	ESTRUSO ILLUMINAZION E NO LED MM L415	1.000	PZ
					MG1099A1	ASSIEME MANIGLIA COMPLETO MMc	1.000	PZ
					SL1170A1	SILICONE ANTRACITE S57 CARTUCCIA 310 ml	30.000	ML
					SL1221A0	SILICONE SUP VETRO EXT GN1/1	1.000	PZ
					SL1222A0	SILICONE LAT VETRO EXT 0511	4.000	PZ
					VE1030A1	CALAMITA D=22,9mm PER MICROPORTA	1.000	PZ
					VI1034A0	RONDELLA PIANA 8.4x16x1 INOX	1.000	PZ
					VI1074A0	VITE PER PLASTICA 4X16 TPBS+ INOX	1.000	PZ
					VI1174A0	VITE 5X20 PER PLASTICA ZN-NI	16.000	PZ
					VI1220A1	VITE AUTOFIL 4.2X11 TCS+ MARUTEX	26.000	PZ
					VI1996A0	VITE M5x35 TCEI ZN	13.000	PZ
					VM1490A0	COPRI VITI MANIGLIA CHEFTOP BAKERTOP	2.000	PZ
					VM1630A1	TAPPO PREMI VETRO INTERNO	3.000	PZ





COMPONENT			SPARE PART					
Code	Description	Image	Code	Description	Kit components			
OB1107A	COLONNINA INTERNA SX PORTA XEVC-0511-E		KDR1261B	0511 -M RIGHT EXTERNAL DOOR	Code	Description	Qty	UOM
					VM1631A0	TAPPO PREMI VETRO INTERNO PLU	3.000	PZ
					VM2259B0	TAPPO INF SX PORTA S6	1.000	PZ
					VM2268A0	TAPPO COPRI CALAMITA PORTA	1.000	PZ
					VM2274A0	BOCCOLA SCANALATA CORTA	1.000	PZ
					VM2275A0	BOCCOLA LISCIA CORTA	1.000	PZ
					VM2284B0	PROFILO SALVAGOCCE SERIE 750	1.000	PZ
					VM2305A0	NOTTOLINO FISSAGGIO TAPPI PORTE MM	14.000	PZ
					VM2312A0	TUBETTO SX SCARICO GOCCIOLATOI O MM	1.000	PZ
					VM2314A0	TAPPINO GOCCIOLATOI O MM	1.000	PZ
					VM2315B0	SUPPORTO SPINGI VETRO INT MM -M	3.000	PZ
					VM2505B1	SUPPORTO PREMI VETRO INT MM PLUS	3.000	PZ
					VM3008A0	ASSEMBLATO TAPPO SUP DX PORTA MM -MV	1.000	PZ
					VM3010A0	ASSEMBLATO TAPPO INF DX PORTA MM -M	1.000	PZ
					VM3011A0	ASSEMBLATO TAPPO SUP SX PORTA S6 -MV	1.000	PZ
					VP1080A0	TAPPO SUP CERNIERA VETRO INTERNO INF	1.000	PZ
					VT1276A0	VETRO ESTERNO SER. XEVC-0511-E	1.000	PZ

COMPONENT			SPARE PART					
Code	Description	Image	Code	Description	Kit components			
0B1107A	COLONNINA INTERNA SX PORTA XEVC-0511-E		KDR1261A	0511 RIGHT EXTERNAL DOOR	Code	Description	Qty	UOM
					0B1106A0	COLONNINA ESTERNA SX PORTA XEVC-0511-E	1.000	PZ
					0B1107A1	COLONNINA INTERNA SX PORTA XEVC-0511-E	1.000	PZ
					0B1108B1	COLONNINA ESTERNA DX PORTA XEVC-0511	1.000	PZ
					0B1109A1	COLONNINA INTERNA DX PORTA XEVC-0511-E	1.000	PZ
					0B1122A1	TRAVERSO INFERIORE PORTA 750 S6	1.000	PZ
					0B1166A1	PROFILO SUPPORTO VETRO EST XEVC-0511-E	2.000	PZ
					0B1216A1	TRAVERSO SUPERIORE PORTA 750mm MM 2V	1.000	PZ
					0B1217A1	TRAVERSO SUPERIORE INT PORTA 750 S6 2V	1.000	PZ
					CE1052A1	CAVO CONNESSION E CONTROLLO- USB MM 750m	1.000	PZ
					CE1053B0	CAVO ALIMENT BARRA LED MM MICROFIT 2P	1.000	PZ
					CE1275A0	CAVO COLLEGAMEN TO POTENZA CONTROLLO 3 M	1.000	PZ
					CE1285A0	FERRITE EMI ROUND MOD. 2643801502	1.000	PZ
					CE1290A0	MORSETTO FEMMINA ESTRAIBILE CPF 5/4	1.000	PZ
					GN1525A0	O-RING D.INT 9.5xSP 1 NBR 7	1.000	PZ

COMPONENT			SPARE PART					
Code	Description	Image	Code	Description	Kit components			
OB1107A	COLONNINA INTERNA SX PORTA XEVC-0511-E		KDR1261A	0511 RIGHT EXTERNAL DOOR	Code	Description	Qty	UOM
					LP1019A0	BARRA ILLUMINAZION E LED MM L200 E415	1.000	PZ
					LP1025A0	ESTRUSO ILLUMINAZION E NO LED MM L415	1.000	PZ
					MG1083A2	ASSIEME MANIGLIA COMPLETO M	1.000	PZ
					SL1170A1	SILICONE ANTRACITE S57 CARTUCCIA 310 ml	30.000	ML
					VE1030A1	CALAMITA D=22,9mm PER MICROPORTA	1.000	PZ
					V11034A0	RONDELLA PIANA 8.4x16x1 INOX	1.000	PZ
					V11147A0	VITE 5X25 TRUCIOLARE INOX	16.000	PZ
					V11220A1	VITE AUTOFIL. 4.2X11 TCS+ MARUTEX	25.000	PZ
					V11996A0	VITE M5x35 TCEI ZN	13.000	PZ
					VM1630A1	TAPPO PREMI VETRO INTERNO	3.000	PZ
					VM1631A0	TAPPO PREMI VETRO INTERNO PLU	2.000	PZ
					VM2259A1	TAPPO INF SX PORTA S6	1.000	PZ
					VM2260A1	TAPPO SUP SX PORTA S6	1.000	PZ
					VM2261A1	TAPPO INF DX PORTA MM	1.000	PZ
					VM2262A1	TAPPO SUP DX PORTA MM	1.000	PZ
					VM2267A1	CORSOIO SISTEMA FERMA VETRO INT	2.000	PZ
					VM2268A0	TAPPO COPRI CALAMITA PORTA	2.000	PZ
					VM2269A0	TAPPO SISTEMA FERMA VETRO INT	2.000	PZ

COMPONENT			SPARE PART																																																		
Code	Description	Image	Code	Description	Kit components																																																
0B1107A	COLONNINA INTERNA SX PORTA XEVC-0511-E		KDR1261A	0511 RIGHT EXTERNAL DOOR	<table border="1"> <thead> <tr> <th>Code</th> <th>Description</th> <th>Qty</th> <th>UOM</th> </tr> </thead> <tbody> <tr> <td>VM2274A0</td> <td>BOCCOLA SCANALATA CORTA</td> <td>1.000</td> <td>PZ</td> </tr> <tr> <td>VM2275A0</td> <td>BOCCOLA LISCIA CORTA</td> <td>1.000</td> <td>PZ</td> </tr> <tr> <td>VM2284A0</td> <td>PROFILO SALVAGOCCE SERIE 750</td> <td>1.000</td> <td>PZ</td> </tr> <tr> <td>VM2305A0</td> <td>NOTTOLINO FISSAGGIO TAPPI PORTE MM</td> <td>14.000</td> <td>PZ</td> </tr> <tr> <td>VM2312A0</td> <td>TUBETTO SX SCARICO GOCCIOLATOI O MM</td> <td>1.000</td> <td>PZ</td> </tr> <tr> <td>VM2314A0</td> <td>TAPPINO GOCCIOLATOI O MM</td> <td>1.000</td> <td>PZ</td> </tr> <tr> <td>VM2315A0</td> <td>SUPPORTO SPINGI VETRO INT MM</td> <td>3.000</td> <td>PZ</td> </tr> <tr> <td>VM2505A0</td> <td>SUPPORTO PREMI VETRO INT MM PLUS</td> <td>2.000</td> <td>PZ</td> </tr> <tr> <td>VM2518A0</td> <td>SUPPORTO VENTOLA RAFF CRUS 20X20 H20</td> <td>1.000</td> <td>PZ</td> </tr> <tr> <td>VN1179A1</td> <td>VENTIL ASSIALE 40x40x20mm 12Vcc</td> <td>1.000</td> <td>PZ</td> </tr> <tr> <td>VT1276A0</td> <td>VETRO ESTERNO SER. XEVC-0511-E</td> <td>1.000</td> <td>PZ</td> </tr> </tbody> </table>	Code	Description	Qty	UOM	VM2274A0	BOCCOLA SCANALATA CORTA	1.000	PZ	VM2275A0	BOCCOLA LISCIA CORTA	1.000	PZ	VM2284A0	PROFILO SALVAGOCCE SERIE 750	1.000	PZ	VM2305A0	NOTTOLINO FISSAGGIO TAPPI PORTE MM	14.000	PZ	VM2312A0	TUBETTO SX SCARICO GOCCIOLATOI O MM	1.000	PZ	VM2314A0	TAPPINO GOCCIOLATOI O MM	1.000	PZ	VM2315A0	SUPPORTO SPINGI VETRO INT MM	3.000	PZ	VM2505A0	SUPPORTO PREMI VETRO INT MM PLUS	2.000	PZ	VM2518A0	SUPPORTO VENTOLA RAFF CRUS 20X20 H20	1.000	PZ	VN1179A1	VENTIL ASSIALE 40x40x20mm 12Vcc	1.000	PZ	VT1276A0	VETRO ESTERNO SER. XEVC-0511-E	1.000	PZ
					Code	Description	Qty	UOM																																													
					VM2274A0	BOCCOLA SCANALATA CORTA	1.000	PZ																																													
					VM2275A0	BOCCOLA LISCIA CORTA	1.000	PZ																																													
					VM2284A0	PROFILO SALVAGOCCE SERIE 750	1.000	PZ																																													
					VM2305A0	NOTTOLINO FISSAGGIO TAPPI PORTE MM	14.000	PZ																																													
					VM2312A0	TUBETTO SX SCARICO GOCCIOLATOI O MM	1.000	PZ																																													
					VM2314A0	TAPPINO GOCCIOLATOI O MM	1.000	PZ																																													
					VM2315A0	SUPPORTO SPINGI VETRO INT MM	3.000	PZ																																													
					VM2505A0	SUPPORTO PREMI VETRO INT MM PLUS	2.000	PZ																																													
					VM2518A0	SUPPORTO VENTOLA RAFF CRUS 20X20 H20	1.000	PZ																																													
					VN1179A1	VENTIL ASSIALE 40x40x20mm 12Vcc	1.000	PZ																																													
					VT1276A0	VETRO ESTERNO SER. XEVC-0511-E	1.000	PZ																																													
0B1108B	COLONNINA ESTERNA DX PORTA XEVC-0511		KDR1325A	0511 ZERO RIGHT -M EXTERNAL DOOR	<table border="1"> <thead> <tr> <th>Code</th> <th>Description</th> <th>Qty</th> <th>UOM</th> </tr> </thead> <tbody> <tr> <td>0B1106A0</td> <td>COLONNINA ESTERNA SX PORTA XEVC-0511-E</td> <td>1.000</td> <td>PZ</td> </tr> <tr> <td>0B1107A1</td> <td>COLONNINA INTERNA SX PORTA XEVC-0511-E</td> <td>1.000</td> <td>PZ</td> </tr> <tr> <td>0B1108B1</td> <td>COLONNINA ESTERNA DX PORTA XEVC-0511</td> <td>1.000</td> <td>PZ</td> </tr> <tr> <td>0B1109A1</td> <td>COLONNINA INTERNA DX PORTA XEVC-0511-E</td> <td>1.000</td> <td>PZ</td> </tr> </tbody> </table>	Code	Description	Qty	UOM	0B1106A0	COLONNINA ESTERNA SX PORTA XEVC-0511-E	1.000	PZ	0B1107A1	COLONNINA INTERNA SX PORTA XEVC-0511-E	1.000	PZ	0B1108B1	COLONNINA ESTERNA DX PORTA XEVC-0511	1.000	PZ	0B1109A1	COLONNINA INTERNA DX PORTA XEVC-0511-E	1.000	PZ																												
					Code	Description	Qty	UOM																																													
					0B1106A0	COLONNINA ESTERNA SX PORTA XEVC-0511-E	1.000	PZ																																													
					0B1107A1	COLONNINA INTERNA SX PORTA XEVC-0511-E	1.000	PZ																																													
0B1108B1	COLONNINA ESTERNA DX PORTA XEVC-0511	1.000	PZ																																																		
0B1109A1	COLONNINA INTERNA DX PORTA XEVC-0511-E	1.000	PZ																																																		

COMPONENT			SPARE PART					
Code	Description	Image	Code	Description	Kit components			
0B1108B	COLONNINA ESTERNA DX PORTA XEVC-0511		KDR1325A	0511 ZERO RIGHT -M EXTERNAL DOOR	Code	Description	Qty	UOM
					0B1122B0	TRAVERSO INFERIORE PORTA 750 MMc	1.000	PZ
					0B1166A1	PROFILO SUPPORTO VETRO EST XEVC-0511-E	2.000	PZ
					0B1216B0	TRAVERSO SUPERIORE PORTA 750 2V MMc	1.000	PZ
					0B1217A1	TRAVERSO SUPERIORE INT PORTA 750 S6 2V	1.000	PZ
					0H2892A0	LAMIERINO TAPPO SUP BARRA LED	1.000	PZ
					0H2893A0	LAMIERINO TAPPO INF BARRA LED	1.000	PZ
					CE1096A0	CAVO BUS MICROFIT 4POLI 3 M	1.000	PZ
					CE1285A0	FERRITE EMI ROUND MOD. 2643801502	2.000	PZ
					CE1851A0	CAVO Y MICROFIT 2P M-F-F AWG22	1.000	PZ
					CE2001A0	CAVO MICROFIT 2PM-100-2PM 2AWG22	1.000	PZ
					CE2002A0	CAVO MICROFIT 2PM-100-AMP MODU2 2AWG22	1.000	PZ
					GN1525A0	O-RING D.INT 9.5xSP 1 NBR 7	1.000	PZ
					LP1019A0	BARRA ILLUMINAZION E LED MM L200 E415	1.000	PZ
					MG1099A1	ASSIEME MANIGLIA COMPLETO MMc	1.000	PZ
					SL1170A1	SILICONE ANTRACITE S57 CARTUCCIA 310 ml	30.000	ML

COMPONENT			SPARE PART					
Code	Description	Image	Code	Description	Kit components			
OB1108B	COLONNINA ESTERNA DX PORTA XEVC-0511		KDR1325A	0511 ZERO RIGHT -M EXTERNAL DOOR	Code	Description	Qty	UOM
					SL1221A0	SILICONE SUP VETRO EXT GN1/1	1.000	PZ
					SL1222A0	SILICONE LAT VETRO EXT 0511	4.000	PZ
					VE1030A1	CALAMITA D=22,9mm PER MICROPORTA	1.000	PZ
					VI1034A0	RONDELLA PIANA 8.4x16x1 INOX	1.000	PZ
					VI1074A0	VITE PER PLASTICA 4X16 TPBS+ INOX	1.000	PZ
					VI1174A0	VITE 5X20 PER PLASTICA ZN-NI	16.000	PZ
					VI1220A1	VITE AUTOFIL. 4.2X11 TCS+ MARUTEX	26.000	PZ
					VI1996A0	VITE M5x35 TCEI ZN	13.000	PZ
					VM1490A0	COPRI VITI MANIGLIA CHEFTOP BAKERTOP	2.000	PZ
					VM1630A1	TAPPO PREMI VETRO INTERNO	3.000	PZ
					VM1631A0	TAPPO PREMI VETRO INTERNO PLU	3.000	PZ
					VM2259B0	TAPPO INF SX PORTA S6	1.000	PZ
					VM2268A0	TAPPO COPRI CALAMITA PORTA	1.000	PZ
					VM2274A0	BOCCOLA SCANALATA CORTA	1.000	PZ
					VM2275A0	BOCCOLA LISCIA CORTA	1.000	PZ
					VM2284B0	PROFILO SALVAGOCCE SERIE 750	1.000	PZ
					VM2305A0	NOTTOLINO FISSAGGIO TAPPI PORTE MM	14.000	PZ
					VM2312A0	TUBETTO SX SCARICO GOCCIOLATOI O MM	1.000	PZ

COMPONENT			SPARE PART																																						
Code	Description	Image	Code	Description	Kit components																																				
0B1108B	COLONNINA ESTERNA DX PORTA XEVC-0511		KDR1325A	0511 ZERO RIGHT -M EXTERNAL DOOR	<table border="1"> <thead> <tr> <th>Code</th> <th>Description</th> <th>Qty</th> <th>UOM</th> </tr> </thead> <tbody> <tr> <td>VM2314A0</td> <td>TAPPINO GOCCIOLATOI O MM</td> <td>1.000</td> <td>PZ</td> </tr> <tr> <td>VM2315B0</td> <td>SUPPORTO SPINGI VETRO INT MM -M</td> <td>3.000</td> <td>PZ</td> </tr> <tr> <td>VM2505B1</td> <td>SUPPORTO PREMI VETRO INT MM PLUS</td> <td>3.000</td> <td>PZ</td> </tr> <tr> <td>VM2956A0</td> <td>ASSEMBLATO TAPPO SUP DX PORTA MM -M</td> <td>1.000</td> <td>PZ</td> </tr> <tr> <td>VM2957A0</td> <td>ASSEMBLATO TAPPO INF DX PORTA MM -M</td> <td>1.000</td> <td>PZ</td> </tr> <tr> <td>VM2958A0</td> <td>ASSEMBLATO TAPPO SUP SX PORTA MM -M</td> <td>1.000</td> <td>PZ</td> </tr> <tr> <td>VP1080A0</td> <td>TAPPO SUP CERNIERA VETRO INTERNO INF</td> <td>1.000</td> <td>PZ</td> </tr> <tr> <td>VT1276A0</td> <td>VETRO ESTERNO SER. XEVC-0511-E</td> <td>1.000</td> <td>PZ</td> </tr> </tbody> </table>	Code	Description	Qty	UOM	VM2314A0	TAPPINO GOCCIOLATOI O MM	1.000	PZ	VM2315B0	SUPPORTO SPINGI VETRO INT MM -M	3.000	PZ	VM2505B1	SUPPORTO PREMI VETRO INT MM PLUS	3.000	PZ	VM2956A0	ASSEMBLATO TAPPO SUP DX PORTA MM -M	1.000	PZ	VM2957A0	ASSEMBLATO TAPPO INF DX PORTA MM -M	1.000	PZ	VM2958A0	ASSEMBLATO TAPPO SUP SX PORTA MM -M	1.000	PZ	VP1080A0	TAPPO SUP CERNIERA VETRO INTERNO INF	1.000	PZ	VT1276A0	VETRO ESTERNO SER. XEVC-0511-E	1.000	PZ
			Code	Description	Qty	UOM																																			
VM2314A0	TAPPINO GOCCIOLATOI O MM	1.000	PZ																																						
VM2315B0	SUPPORTO SPINGI VETRO INT MM -M	3.000	PZ																																						
VM2505B1	SUPPORTO PREMI VETRO INT MM PLUS	3.000	PZ																																						
VM2956A0	ASSEMBLATO TAPPO SUP DX PORTA MM -M	1.000	PZ																																						
VM2957A0	ASSEMBLATO TAPPO INF DX PORTA MM -M	1.000	PZ																																						
VM2958A0	ASSEMBLATO TAPPO SUP SX PORTA MM -M	1.000	PZ																																						
VP1080A0	TAPPO SUP CERNIERA VETRO INTERNO INF	1.000	PZ																																						
VT1276A0	VETRO ESTERNO SER. XEVC-0511-E	1.000	PZ																																						
KDR1269B	BT-04 -M EXTERNAL RIGHT DOOR	<table border="1"> <thead> <tr> <th>Code</th> <th>Description</th> <th>Qty</th> <th>UOM</th> </tr> </thead> <tbody> <tr> <td>0B1107A1</td> <td>COLONNINA INTERNA SX PORTA XEVC-0511-E</td> <td>1.000</td> <td>PZ</td> </tr> <tr> <td>0B1108B1</td> <td>COLONNINA ESTERNA DX PORTA XEVC-0511</td> <td>1.000</td> <td>PZ</td> </tr> <tr> <td>0B1109A1</td> <td>COLONNINA INTERNA DX PORTA XEVC-0511-E</td> <td>1.000</td> <td>PZ</td> </tr> <tr> <td>0B1126B0</td> <td>TRAVERSO INFERIORE PORTA 860 M</td> <td>1.000</td> <td>PZ</td> </tr> <tr> <td>0B1166A1</td> <td>PROFILO SUPPORTO VETRO EST XEVC-0511-E</td> <td>2.000</td> <td>PZ</td> </tr> <tr> <td>0B1174A0</td> <td>COLONNINA ESTERNA SX PORTA XEBC-04EU-E</td> <td>1.000</td> <td>PZ</td> </tr> </tbody> </table>	Code	Description	Qty	UOM	0B1107A1	COLONNINA INTERNA SX PORTA XEVC-0511-E	1.000	PZ	0B1108B1	COLONNINA ESTERNA DX PORTA XEVC-0511	1.000	PZ	0B1109A1	COLONNINA INTERNA DX PORTA XEVC-0511-E	1.000	PZ	0B1126B0	TRAVERSO INFERIORE PORTA 860 M	1.000	PZ	0B1166A1	PROFILO SUPPORTO VETRO EST XEVC-0511-E	2.000	PZ	0B1174A0	COLONNINA ESTERNA SX PORTA XEBC-04EU-E	1.000	PZ											
Code	Description	Qty	UOM																																						
0B1107A1	COLONNINA INTERNA SX PORTA XEVC-0511-E	1.000	PZ																																						
0B1108B1	COLONNINA ESTERNA DX PORTA XEVC-0511	1.000	PZ																																						
0B1109A1	COLONNINA INTERNA DX PORTA XEVC-0511-E	1.000	PZ																																						
0B1126B0	TRAVERSO INFERIORE PORTA 860 M	1.000	PZ																																						
0B1166A1	PROFILO SUPPORTO VETRO EST XEVC-0511-E	2.000	PZ																																						
0B1174A0	COLONNINA ESTERNA SX PORTA XEBC-04EU-E	1.000	PZ																																						

COMPONENT			SPARE PART																																																														
Code	Description	Image	Code	Description	Kit components																																																												
OB1108B	COLONNINA ESTERNA DX PORTA XEVC-0511		KDR1269B	BT-04 -M EXTERNAL RIGHT DOOR	<table border="1"> <thead> <tr> <th>Code</th> <th>Description</th> <th>Qty</th> <th>UOM</th> </tr> </thead> <tbody> <tr> <td>OB1218B0</td> <td>TRAVERSO SUPERIORE PORTA 860 2V MMc</td> <td>1.000</td> <td>PZ</td> </tr> <tr> <td>OB1219A1</td> <td>TRAVERSO SUPERIORE INT PORTA 860 S6 2V</td> <td>1.000</td> <td>PZ</td> </tr> <tr> <td>CE1052A1</td> <td>CAVO CONNESSIONE CONTROLLO-USB MM 750m</td> <td>1.000</td> <td>PZ</td> </tr> <tr> <td>CE1053B0</td> <td>CAVO ALIMENT BARRA LED MM MICROFIT 2P</td> <td>1.000</td> <td>PZ</td> </tr> <tr> <td>CE1097A0</td> <td>CAVO BUS MICROFIT 4 POLI SIHF 4M</td> <td>1.000</td> <td>PZ</td> </tr> <tr> <td>CE1285A0</td> <td>FERRITE EMI ROUND MOD. 2643801502</td> <td>2.000</td> <td>PZ</td> </tr> <tr> <td>LP1019A0</td> <td>BARRA ILLUMINAZIONE LED MM L200 E415</td> <td>1.000</td> <td>PZ</td> </tr> <tr> <td>LP1025A0</td> <td>ESTRUSO ILLUMINAZIONE LED MM L415</td> <td>1.000</td> <td>PZ</td> </tr> <tr> <td>MG1099A1</td> <td>ASSIEME MANIGLIA COMPLETO MMc</td> <td>1.000</td> <td>PZ</td> </tr> <tr> <td>SL1170A1</td> <td>SILICONE ANTRACITE S57 CARTUCCIA 310 ml</td> <td>35.000</td> <td>ML</td> </tr> <tr> <td>SL1222A0</td> <td>SILICONE LAT VETRO EXT 0511</td> <td>4.000</td> <td>PZ</td> </tr> <tr> <td>SL1229A0</td> <td>SILICONE SUP VETRO EXT BAKER</td> <td>1.000</td> <td>PZ</td> </tr> <tr> <td>VE1030A1</td> <td>CALAMITA D=22,9mm PER MICROPORTA</td> <td>1.000</td> <td>PZ</td> </tr> <tr> <td>VI1074A0</td> <td>VITE PER PLASTICA 4X16 TPBS+ INOX</td> <td>4.000</td> <td>PZ</td> </tr> </tbody> </table>	Code	Description	Qty	UOM	OB1218B0	TRAVERSO SUPERIORE PORTA 860 2V MMc	1.000	PZ	OB1219A1	TRAVERSO SUPERIORE INT PORTA 860 S6 2V	1.000	PZ	CE1052A1	CAVO CONNESSIONE CONTROLLO-USB MM 750m	1.000	PZ	CE1053B0	CAVO ALIMENT BARRA LED MM MICROFIT 2P	1.000	PZ	CE1097A0	CAVO BUS MICROFIT 4 POLI SIHF 4M	1.000	PZ	CE1285A0	FERRITE EMI ROUND MOD. 2643801502	2.000	PZ	LP1019A0	BARRA ILLUMINAZIONE LED MM L200 E415	1.000	PZ	LP1025A0	ESTRUSO ILLUMINAZIONE LED MM L415	1.000	PZ	MG1099A1	ASSIEME MANIGLIA COMPLETO MMc	1.000	PZ	SL1170A1	SILICONE ANTRACITE S57 CARTUCCIA 310 ml	35.000	ML	SL1222A0	SILICONE LAT VETRO EXT 0511	4.000	PZ	SL1229A0	SILICONE SUP VETRO EXT BAKER	1.000	PZ	VE1030A1	CALAMITA D=22,9mm PER MICROPORTA	1.000	PZ	VI1074A0	VITE PER PLASTICA 4X16 TPBS+ INOX	4.000	PZ
					Code	Description	Qty	UOM																																																									
					OB1218B0	TRAVERSO SUPERIORE PORTA 860 2V MMc	1.000	PZ																																																									
					OB1219A1	TRAVERSO SUPERIORE INT PORTA 860 S6 2V	1.000	PZ																																																									
					CE1052A1	CAVO CONNESSIONE CONTROLLO-USB MM 750m	1.000	PZ																																																									
					CE1053B0	CAVO ALIMENT BARRA LED MM MICROFIT 2P	1.000	PZ																																																									
					CE1097A0	CAVO BUS MICROFIT 4 POLI SIHF 4M	1.000	PZ																																																									
					CE1285A0	FERRITE EMI ROUND MOD. 2643801502	2.000	PZ																																																									
					LP1019A0	BARRA ILLUMINAZIONE LED MM L200 E415	1.000	PZ																																																									
					LP1025A0	ESTRUSO ILLUMINAZIONE LED MM L415	1.000	PZ																																																									
					MG1099A1	ASSIEME MANIGLIA COMPLETO MMc	1.000	PZ																																																									
					SL1170A1	SILICONE ANTRACITE S57 CARTUCCIA 310 ml	35.000	ML																																																									
					SL1222A0	SILICONE LAT VETRO EXT 0511	4.000	PZ																																																									
					SL1229A0	SILICONE SUP VETRO EXT BAKER	1.000	PZ																																																									
					VE1030A1	CALAMITA D=22,9mm PER MICROPORTA	1.000	PZ																																																									
VI1074A0	VITE PER PLASTICA 4X16 TPBS+ INOX	4.000	PZ																																																														

COMPONENT			SPARE PART					
Code	Description	Image	Code	Description	Kit components			
OB1108B	COLONNINA ESTERNA DX PORTA XEVC-0511		KDR1269B	BT-04 -M EXTERNAL RIGHT DOOR	Code	Description	Qty	UOM
					VI1103A0	VITE PER PLASTICA 4X12 TPBS+ ZN-NI	2.000	PZ
					VI1174A0	VITE 5X20 PER PLASTICA ZN-NI	16.000	PZ
					VI1220A1	VITE AUTOFIL. 4.2X11 TCS+ MARUTEX	28.000	PZ
					VI1996A0	VITE M5x35 TCEI ZN	13.000	PZ
					VM1490A0	COPRI VITI MANIGLIA CHEFTOP BAKERTOP	2.000	PZ
					VM1630A1	TAPPO PREMI VETRO INTERNO	3.000	PZ
					VM1631A0	TAPPO PREMI VETRO INTERNO PLU	3.000	PZ
					VM2259B0	TAPPO INF SX PORTA S6	1.000	PZ
					VM2268A0	TAPPO COPRI CALAMITA PORTA	1.000	PZ
					VM2274A0	BOCCOLA SCANALATA CORTA	1.000	PZ
					VM2275A0	BOCCOLA LISCIA CORTA	1.000	PZ
					VM2285B0	PROFILO SALVAGOCCE SERIE 860	1.000	PZ
					VM2305A0	NOTTOLINO FISSAGGIO TAPPI PORTE MM	14.000	PZ
					VM2312A0	TUBETTO SX SCARICO GOCCIOLATOI O MM	1.000	PZ
					VM2314A0	TAPPINO GOCCIOLATOI O MM	1.000	PZ
VM2315B0	SUPPORTO SPINGI VETRO INT MM -M	3.000	PZ					
VM2505B1	SUPPORTO PREMI VETRO INT MM PLUS	3.000	PZ					

COMPONENT			SPARE PART																																		
Code	Description	Image	Code	Description	Kit components																																
OB1108B	COLONNINA ESTERNA DX PORTA XEVC-0511		KDR1269B	BT-04 -M EXTERNAL RIGHT DOOR	<table border="1"> <thead> <tr> <th>Code</th> <th>Description</th> <th>Qty</th> <th>UOM</th> </tr> </thead> <tbody> <tr> <td>VM2518A0</td> <td>SUPPORTO VENTOLA RAFF CRUS 20X20 H20</td> <td>1.000</td> <td>PZ</td> </tr> <tr> <td>VM3008A0</td> <td>ASSEMBLATO TAPPO SUP DX PORTA MM -MV</td> <td>1.000</td> <td>PZ</td> </tr> <tr> <td>VM3010A0</td> <td>ASSEMBLATO TAPPO INF DX PORTA MM -M</td> <td>1.000</td> <td>PZ</td> </tr> <tr> <td>VM3011A0</td> <td>ASSEMBLATO TAPPO SUP SX PORTA S6 -MV</td> <td>1.000</td> <td>PZ</td> </tr> <tr> <td>VN1179A1</td> <td>VENTIL ASSIALE 40x40x20mm 12Vcc</td> <td>1.000</td> <td>PZ</td> </tr> <tr> <td>VP1080A0</td> <td>TAPPO SUP CERNIERA VETRO INTERNO INF</td> <td>1.000</td> <td>PZ</td> </tr> <tr> <td>VT1290A0</td> <td>VETRO EST. SER. XEBC-04EU-E</td> <td>1.000</td> <td>PZ</td> </tr> </tbody> </table>	Code	Description	Qty	UOM	VM2518A0	SUPPORTO VENTOLA RAFF CRUS 20X20 H20	1.000	PZ	VM3008A0	ASSEMBLATO TAPPO SUP DX PORTA MM -MV	1.000	PZ	VM3010A0	ASSEMBLATO TAPPO INF DX PORTA MM -M	1.000	PZ	VM3011A0	ASSEMBLATO TAPPO SUP SX PORTA S6 -MV	1.000	PZ	VN1179A1	VENTIL ASSIALE 40x40x20mm 12Vcc	1.000	PZ	VP1080A0	TAPPO SUP CERNIERA VETRO INTERNO INF	1.000	PZ	VT1290A0	VETRO EST. SER. XEBC-04EU-E	1.000	PZ
			Code	Description	Qty	UOM																															
VM2518A0	SUPPORTO VENTOLA RAFF CRUS 20X20 H20	1.000	PZ																																		
VM3008A0	ASSEMBLATO TAPPO SUP DX PORTA MM -MV	1.000	PZ																																		
VM3010A0	ASSEMBLATO TAPPO INF DX PORTA MM -M	1.000	PZ																																		
VM3011A0	ASSEMBLATO TAPPO SUP SX PORTA S6 -MV	1.000	PZ																																		
VN1179A1	VENTIL ASSIALE 40x40x20mm 12Vcc	1.000	PZ																																		
VP1080A0	TAPPO SUP CERNIERA VETRO INTERNO INF	1.000	PZ																																		
VT1290A0	VETRO EST. SER. XEBC-04EU-E	1.000	PZ																																		
KDR1269A	BT-04 EXTERNAL RIGHT DOOR	<table border="1"> <thead> <tr> <th>Code</th> <th>Description</th> <th>Qty</th> <th>UOM</th> </tr> </thead> <tbody> <tr> <td>OB1107A1</td> <td>COLONNINA INTERNA SX PORTA XEVC-0511-E</td> <td>1.000</td> <td>PZ</td> </tr> <tr> <td>OB1108B1</td> <td>COLONNINA ESTERNA DX PORTA XEVC-0511</td> <td>1.000</td> <td>PZ</td> </tr> <tr> <td>OB1109A1</td> <td>COLONNINA INTERNA DX PORTA XEVC-0511-E</td> <td>1.000</td> <td>PZ</td> </tr> <tr> <td>OB1126A1</td> <td>TRAVERSO INFERIORE PORTA 860 M</td> <td>1.000</td> <td>PZ</td> </tr> <tr> <td>OB1166A1</td> <td>PROFILO SUPPORTO VETRO EST XEVC-0511-E</td> <td>2.000</td> <td>PZ</td> </tr> <tr> <td>OB1174A0</td> <td>COLONNINA ESTERNA SX PORTA XEBC-04EU-E</td> <td>1.000</td> <td>PZ</td> </tr> <tr> <td>OB1218A1</td> <td>TRAVERSO SUPERIORE PORTA 860 MM 2V</td> <td>1.000</td> <td>PZ</td> </tr> </tbody> </table>	Code	Description	Qty	UOM	OB1107A1	COLONNINA INTERNA SX PORTA XEVC-0511-E	1.000	PZ	OB1108B1	COLONNINA ESTERNA DX PORTA XEVC-0511	1.000	PZ	OB1109A1	COLONNINA INTERNA DX PORTA XEVC-0511-E	1.000	PZ	OB1126A1	TRAVERSO INFERIORE PORTA 860 M	1.000	PZ	OB1166A1	PROFILO SUPPORTO VETRO EST XEVC-0511-E	2.000	PZ	OB1174A0	COLONNINA ESTERNA SX PORTA XEBC-04EU-E	1.000	PZ	OB1218A1	TRAVERSO SUPERIORE PORTA 860 MM 2V	1.000	PZ			
Code	Description	Qty	UOM																																		
OB1107A1	COLONNINA INTERNA SX PORTA XEVC-0511-E	1.000	PZ																																		
OB1108B1	COLONNINA ESTERNA DX PORTA XEVC-0511	1.000	PZ																																		
OB1109A1	COLONNINA INTERNA DX PORTA XEVC-0511-E	1.000	PZ																																		
OB1126A1	TRAVERSO INFERIORE PORTA 860 M	1.000	PZ																																		
OB1166A1	PROFILO SUPPORTO VETRO EST XEVC-0511-E	2.000	PZ																																		
OB1174A0	COLONNINA ESTERNA SX PORTA XEBC-04EU-E	1.000	PZ																																		
OB1218A1	TRAVERSO SUPERIORE PORTA 860 MM 2V	1.000	PZ																																		

COMPONENT			SPARE PART					
Code	Description	Image	Code	Description	Kit components			
OB1108B	COLONNINA ESTERNA DX PORTA XEVC-0511		KDR1269A	BT-04 EXTERNAL RIGHT DOOR	Code	Description	Qty	UOM
					0B1219A1	TRAVERSO SUPERIORE INT PORTA 860 S6 2V	1.000	PZ
					CE1052A1	CAVO CONNESSIONE E CONTROLLO-USB MM 750m	1.000	PZ
					CE1053B0	CAVO ALIMENT BARRA LED MM MICROFIT 2P	1.000	PZ
					CE1285A0	FERRITE EMI ROUND MOD. 2643801502	1.000	PZ
					CE1290A0	MORSETTO FEMMINA ESTRAIBILE CPF 5/4	1.000	PZ
					CE1310A1	CAVO COLLEGAMEN TO POTENZA CONTROLLO L4 M	1.000	PZ
					LP1019A0	BARRA ILLUMINAZIONE LED MM L200 E415	1.000	PZ
					LP1025A0	ESTRUSO ILLUMINAZIONE NO LED MM L415	1.000	PZ
					MG1083A2	ASSIEME MANIGLIA COMPLETO M	1.000	PZ
					SL1170A1	SILICONE ANTRACITE S57 CARTUCCIA 310 ml	30.000	ML
					VE1030A1	CALAMITA D=22,9mm PER MICROPORTA	1.000	PZ
					VI1147A0	VITE 5X25 TRUCIOLARE INOX	16.000	PZ
					VI1220A1	VITE AUTOFIL 4.2X11 TCS+ MARUTEX	25.000	PZ
					VI1996A0	VITE M5x35 TCEI ZN	13.000	PZ

COMPONENT			SPARE PART					
Code	Description	Image	Code	Description	Kit components			
OB1108B	COLONNINA ESTERNA DX PORTA XEVC-0511		KDR1269A	BT-04 EXTERNAL RIGHT DOOR	Code	Description	Qty	UOM
					VM1630A1	TAPPO PREMI VETRO INTERNO	3.000	PZ
					VM1631A0	TAPPO PREMI VETRO INTERNO PLU	2.000	PZ
					VM2259A1	TAPPO INF SX PORTA S6	1.000	PZ
					VM2260A1	TAPPO SUP SX PORTA S6	1.000	PZ
					VM2261A1	TAPPO INF DX PORTA MM	1.000	PZ
					VM2262A1	TAPPO SUP DX PORTA MM	1.000	PZ
					VM2267A1	CORSOIO SISTEMA FERMA VETRO INT	2.000	PZ
					VM2268A0	TAPPO COPRI CALAMITA PORTA	2.000	PZ
					VM2269A0	TAPPO SISTEMA FERMA VETRO INT	2.000	PZ
					VM2274A0	BOCCOLA SCANALATA CORTA	1.000	PZ
					VM2275A0	BOCCOLA LISCIA CORTA	1.000	PZ
					VM2285A0	PROFILO SALVAGOCCE SERIE 860	1.000	PZ
					VM2305A0	NOTTOLINO FISSAGGIO TAPPI PORTE MM	14.000	PZ
					VM2312A0	TUBETTO SX SCARICO GOCCIOLATOI O MM	1.000	PZ
					VM2313A0	TUBETTO DX SCARICO GOCCIOLATOI O MM	1.000	PZ
					VM2314A0	TAPPINO GOCCIOLATOI O MM	1.000	PZ
					VM2315A0	SUPPORTO SPINGI VETRO INT MM	3.000	PZ
					VM2505A0	SUPPORTO PREMI VETRO INT MM PLUS	2.000	PZ



COMPONENT			SPARE PART																																											
Code	Description	Image	Code	Description	Kit components																																									
OB1108B	COLONNINA ESTERNA DX PORTA XEVC-0511		KDR1269A	BT-04 EXTERNAL RIGHT DOOR	<table border="1"> <thead> <tr> <th>Code</th> <th>Description</th> <th>Qty</th> <th>UOM</th> </tr> </thead> <tbody> <tr> <td>VM2518A0</td> <td>SUPPORTO VENTOLA RAFF CRUS 20X20 H20</td> <td>1.000</td> <td>PZ</td> </tr> <tr> <td>VN1179A1</td> <td>VENTIL ASSIALE 40x40x20mm 12Vcc</td> <td>1.000</td> <td>PZ</td> </tr> <tr> <td>VT1290A0</td> <td>VETRO EST. SER. XEBC-04EU-E</td> <td>1.000</td> <td>PZ</td> </tr> </tbody> </table>	Code	Description	Qty	UOM	VM2518A0	SUPPORTO VENTOLA RAFF CRUS 20X20 H20	1.000	PZ	VN1179A1	VENTIL ASSIALE 40x40x20mm 12Vcc	1.000	PZ	VT1290A0	VETRO EST. SER. XEBC-04EU-E	1.000	PZ																									
			Code	Description	Qty	UOM																																								
VM2518A0	SUPPORTO VENTOLA RAFF CRUS 20X20 H20	1.000	PZ																																											
VN1179A1	VENTIL ASSIALE 40x40x20mm 12Vcc	1.000	PZ																																											
VT1290A0	VETRO EST. SER. XEBC-04EU-E	1.000	PZ																																											
KDR1261B	0511 -M RIGHT EXTERNAL DOOR	<table border="1"> <thead> <tr> <th>Code</th> <th>Description</th> <th>Qty</th> <th>UOM</th> </tr> </thead> <tbody> <tr> <td>OB1106A0</td> <td>COLONNINA ESTERNA SX PORTA XEVC-0511-E</td> <td>1.000</td> <td>PZ</td> </tr> <tr> <td>OB1107A1</td> <td>COLONNINA INTERNA SX PORTA XEVC-0511-E</td> <td>1.000</td> <td>PZ</td> </tr> <tr> <td>OB1108B1</td> <td>COLONNINA ESTERNA DX PORTA XEVC-0511</td> <td>1.000</td> <td>PZ</td> </tr> <tr> <td>OB1109A1</td> <td>COLONNINA INTERNA DX PORTA XEVC-0511-E</td> <td>1.000</td> <td>PZ</td> </tr> <tr> <td>OB1122B0</td> <td>TRAVERSO INFERIORE PORTA 750 MMc</td> <td>1.000</td> <td>PZ</td> </tr> <tr> <td>OB1166A1</td> <td>PROFILO SUPPORTO VETRO EST XEVC-0511-E</td> <td>2.000</td> <td>PZ</td> </tr> <tr> <td>OB1216B0</td> <td>TRAVERSO SUPERIORE PORTA 750 2V MMc</td> <td>1.000</td> <td>PZ</td> </tr> <tr> <td>OB1217A1</td> <td>TRAVERSO SUPERIORE INT PORTA 750 S6 2V</td> <td>1.000</td> <td>PZ</td> </tr> <tr> <td>CE1052A1</td> <td>CAVO CONNESSION E CONTROLLO- USB MM 750m</td> <td>1.000</td> <td>PZ</td> </tr> <tr> <td>CE1053B0</td> <td>CAVO ALIMENT BARRA LED MM MICROFIT 2P</td> <td>1.000</td> <td>PZ</td> </tr> </tbody> </table>	Code	Description	Qty	UOM	OB1106A0	COLONNINA ESTERNA SX PORTA XEVC-0511-E	1.000	PZ	OB1107A1	COLONNINA INTERNA SX PORTA XEVC-0511-E	1.000	PZ	OB1108B1	COLONNINA ESTERNA DX PORTA XEVC-0511	1.000	PZ	OB1109A1	COLONNINA INTERNA DX PORTA XEVC-0511-E	1.000	PZ	OB1122B0	TRAVERSO INFERIORE PORTA 750 MMc	1.000	PZ	OB1166A1	PROFILO SUPPORTO VETRO EST XEVC-0511-E	2.000	PZ	OB1216B0	TRAVERSO SUPERIORE PORTA 750 2V MMc	1.000	PZ	OB1217A1	TRAVERSO SUPERIORE INT PORTA 750 S6 2V	1.000	PZ	CE1052A1	CAVO CONNESSION E CONTROLLO- USB MM 750m	1.000	PZ	CE1053B0	CAVO ALIMENT BARRA LED MM MICROFIT 2P	1.000	PZ
Code	Description	Qty	UOM																																											
OB1106A0	COLONNINA ESTERNA SX PORTA XEVC-0511-E	1.000	PZ																																											
OB1107A1	COLONNINA INTERNA SX PORTA XEVC-0511-E	1.000	PZ																																											
OB1108B1	COLONNINA ESTERNA DX PORTA XEVC-0511	1.000	PZ																																											
OB1109A1	COLONNINA INTERNA DX PORTA XEVC-0511-E	1.000	PZ																																											
OB1122B0	TRAVERSO INFERIORE PORTA 750 MMc	1.000	PZ																																											
OB1166A1	PROFILO SUPPORTO VETRO EST XEVC-0511-E	2.000	PZ																																											
OB1216B0	TRAVERSO SUPERIORE PORTA 750 2V MMc	1.000	PZ																																											
OB1217A1	TRAVERSO SUPERIORE INT PORTA 750 S6 2V	1.000	PZ																																											
CE1052A1	CAVO CONNESSION E CONTROLLO- USB MM 750m	1.000	PZ																																											
CE1053B0	CAVO ALIMENT BARRA LED MM MICROFIT 2P	1.000	PZ																																											

COMPONENT			SPARE PART					
Code	Description	Image	Code	Description	Kit components			
OB1108B	COLONNINA ESTERNA DX PORTA XEVC-0511		KDR1261B	0511 -M RIGHT EXTERNAL DOOR	Code	Description	Qty	UOM
					CE1096A0	CAVO BUS MICROFIT 4POLI 3 M	1.000	PZ
					CE1285A0	FERRITE EMI ROUND MOD. 2643801502	2.000	PZ
					GN1525A0	O-RING D.INT 9.5xSP 1 NBR 7	1.000	PZ
					LP1019A0	BARRA ILLUMINAZION E LED MM L200 E415	1.000	PZ
					LP1025A0	ESTRUSO ILLUMINAZION E NO LED MM L415	1.000	PZ
					MG1099A1	ASSIEME MANIGLIA COMPLETO MMc	1.000	PZ
					SL1170A1	SILICONE ANTRACITE S57 CARTUCCIA 310 ml	30.000	ML
					SL1221A0	SILICONE SUP VETRO EXT GN1/1	1.000	PZ
					SL1222A0	SILICONE LAT VETRO EXT 0511	4.000	PZ
					VE1030A1	CALAMITA D=22,9mm PER MICROPORTA	1.000	PZ
					VI1034A0	RONDELLA PIANA 8.4x16x1 INOX	1.000	PZ
					VI1074A0	VITE PER PLASTICA 4X16 TPBS+ INOX	1.000	PZ
					VI1174A0	VITE 5X20 PER PLASTICA ZN-NI	16.000	PZ
					VI1220A1	VITE AUTOFIL. 4.2X11 TCS+ MARUTEX	26.000	PZ
					VI1996A0	VITE M5x35 TCEI ZN	13.000	PZ
					VM1490A0	COPRI VITI MANIGLIA CHEFTOP BAKERTOP	2.000	PZ

COMPONENT			SPARE PART					
Code	Description	Image	Code	Description	Kit components			
OB1108B	COLONNINA ESTERNA DX PORTA XEVC-0511		KDR1261B	0511 -M RIGHT EXTERNAL DOOR	Code	Description	Qty	UOM
					VM1630A1	TAPPO PREMI VETRO INTERNO	3.000	PZ
					VM1631A0	TAPPO PREMI VETRO INTERNO PLU	3.000	PZ
					VM2259B0	TAPPO INF SX PORTA S6	1.000	PZ
					VM2268A0	TAPPO COPRI CALAMITA PORTA	1.000	PZ
					VM2274A0	BOCCOLA SCANALATA CORTA	1.000	PZ
					VM2275A0	BOCCOLA LISCIA CORTA	1.000	PZ
					VM2284B0	PROFILO SALVAGOCCE SERIE 750	1.000	PZ
					VM2305A0	NOTTOLINO FISSAGGIO TAPPI PORTE MM	14.000	PZ
					VM2312A0	TUBETTO SX SCARICO GOCCIOLATOI O MM	1.000	PZ
					VM2314A0	TAPPINO GOCCIOLATOI O MM	1.000	PZ
					VM2315B0	SUPPORTO SPINGI VETRO INT MM -M	3.000	PZ
					VM2505B1	SUPPORTO PREMI VETRO INT MM PLUS	3.000	PZ
					VM3008A0	ASSEMBLATO TAPPO SUP DX PORTA MM -MV	1.000	PZ
					VM3010A0	ASSEMBLATO TAPPO INF DX PORTA MM -M	1.000	PZ
					VM3011A0	ASSEMBLATO TAPPO SUP SX PORTA S6 -MV	1.000	PZ
					VP1080A0	TAPPO SUP CERNIERA VETRO INTERNO INF	1.000	PZ
					VT1276A0	VETRO ESTERNO SER. XEVC-0511-E	1.000	PZ

COMPONENT			SPARE PART					
Code	Description	Image	Code	Description	Kit components			
OB1108B	COLONNINA ESTERNA DX PORTA XEVC-0511		KDR1261A	0511 RIGHT EXTERNAL DOOR	Code	Description	Qty	UOM
					0B1106A0	COLONNINA ESTERNA SX PORTA XEVC-0511-E	1.000	PZ
					0B1107A1	COLONNINA INTERNA SX PORTA XEVC-0511-E	1.000	PZ
					0B1108B1	COLONNINA ESTERNA DX PORTA XEVC-0511	1.000	PZ
					0B1109A1	COLONNINA INTERNA DX PORTA XEVC-0511-E	1.000	PZ
					0B1122A1	TRAVERSO INFERIORE PORTA 750 S6	1.000	PZ
					0B1166A1	PROFILO SUPPORTO VETRO EST XEVC-0511-E	2.000	PZ
					0B1216A1	TRAVERSO SUPERIORE PORTA 750mm MM 2V	1.000	PZ
					0B1217A1	TRAVERSO SUPERIORE INT PORTA 750 S6 2V	1.000	PZ
					CE1052A1	CAVO CONNESSION E CONTROLLO- USB MM 750m	1.000	PZ
					CE1053B0	CAVO ALIMENT BARRA LED MM MICROFIT 2P	1.000	PZ
					CE1275A0	CAVO COLLEGAMEN TO POTENZA CONTROLLO 3 M	1.000	PZ
					CE1285A0	FERRITE EMI ROUND MOD. 2643801502	1.000	PZ
					CE1290A0	MORSETTO FEMMINA ESTRAIBILE CPF 5/4	1.000	PZ
GN1525A0	O-RING D.INT 9.5xSP 1 NBR 7	1.000	PZ					

COMPONENT			SPARE PART					
Code	Description	Image	Code	Description	Kit components			
OB1108B	COLONNINA ESTERNA DX PORTA XEVC-0511		KDR1261A	0511 RIGHT EXTERNAL DOOR	Code	Description	Qty	UOM
					LP1019A0	BARRA ILLUMINAZION E LED MM L200 E415	1.000	PZ
					LP1025A0	ESTRUSO ILLUMINAZION E NO LED MM L415	1.000	PZ
					MG1083A2	ASSIEME MANIGLIA COMPLETO M	1.000	PZ
					SL1170A1	SILICONE ANTRACITE S57 CARTUCCIA 310 ml	30.000	ML
					VE1030A1	CALAMITA D=22,9mm PER MICROPORTA	1.000	PZ
					V11034A0	RONDELLA PIANA 8.4x16x1 INOX	1.000	PZ
					V11147A0	VITE 5X25 TRUCIOLARE INOX	16.000	PZ
					V11220A1	VITE AUTOFIL. 4.2X11 TCS+ MARUTEX	25.000	PZ
					V11996A0	VITE M5x35 TCEI ZN	13.000	PZ
					VM1630A1	TAPPO PREMI VETRO INTERNO	3.000	PZ
					VM1631A0	TAPPO PREMI VETRO INTERNO PLU	2.000	PZ
					VM2259A1	TAPPO INF SX PORTA S6	1.000	PZ
					VM2260A1	TAPPO SUP SX PORTA S6	1.000	PZ
					VM2261A1	TAPPO INF DX PORTA MM	1.000	PZ
					VM2262A1	TAPPO SUP DX PORTA MM	1.000	PZ
					VM2267A1	CORSOIO SISTEMA FERMA VETRO INT	2.000	PZ
					VM2268A0	TAPPO COPRI CALAMITA PORTA	2.000	PZ
					VM2269A0	TAPPO SISTEMA FERMA VETRO INT	2.000	PZ

COMPONENT			SPARE PART																																																		
Code	Description	Image	Code	Description	Kit components																																																
0B1108B	COLONNINA ESTERNA DX PORTA XEVC-0511		KDR1261A	0511 RIGHT EXTERNAL DOOR	<table border="1"> <thead> <tr> <th>Code</th> <th>Description</th> <th>Qty</th> <th>UOM</th> </tr> </thead> <tbody> <tr> <td>VM2274A0</td> <td>BOCCOLA SCANALATA CORTA</td> <td>1.000</td> <td>PZ</td> </tr> <tr> <td>VM2275A0</td> <td>BOCCOLA LISCIA CORTA</td> <td>1.000</td> <td>PZ</td> </tr> <tr> <td>VM2284A0</td> <td>PROFILO SALVAGOCCE SERIE 750</td> <td>1.000</td> <td>PZ</td> </tr> <tr> <td>VM2305A0</td> <td>NOTTOLINO FISSAGGIO TAPPI PORTE MM</td> <td>14.000</td> <td>PZ</td> </tr> <tr> <td>VM2312A0</td> <td>TUBETTO SX SCARICO GOCCIOLATOI O MM</td> <td>1.000</td> <td>PZ</td> </tr> <tr> <td>VM2314A0</td> <td>TAPPINO GOCCIOLATOI O MM</td> <td>1.000</td> <td>PZ</td> </tr> <tr> <td>VM2315A0</td> <td>SUPPORTO SPINGI VETRO INT MM</td> <td>3.000</td> <td>PZ</td> </tr> <tr> <td>VM2505A0</td> <td>SUPPORTO PREMI VETRO INT MM PLUS</td> <td>2.000</td> <td>PZ</td> </tr> <tr> <td>VM2518A0</td> <td>SUPPORTO VENTOLA RAFF CRUS 20X20 H20</td> <td>1.000</td> <td>PZ</td> </tr> <tr> <td>VN1179A1</td> <td>VENTIL ASSIALE 40x40x20mm 12Vcc</td> <td>1.000</td> <td>PZ</td> </tr> <tr> <td>VT1276A0</td> <td>VETRO ESTERNO SER. XEVC-0511-E</td> <td>1.000</td> <td>PZ</td> </tr> </tbody> </table>	Code	Description	Qty	UOM	VM2274A0	BOCCOLA SCANALATA CORTA	1.000	PZ	VM2275A0	BOCCOLA LISCIA CORTA	1.000	PZ	VM2284A0	PROFILO SALVAGOCCE SERIE 750	1.000	PZ	VM2305A0	NOTTOLINO FISSAGGIO TAPPI PORTE MM	14.000	PZ	VM2312A0	TUBETTO SX SCARICO GOCCIOLATOI O MM	1.000	PZ	VM2314A0	TAPPINO GOCCIOLATOI O MM	1.000	PZ	VM2315A0	SUPPORTO SPINGI VETRO INT MM	3.000	PZ	VM2505A0	SUPPORTO PREMI VETRO INT MM PLUS	2.000	PZ	VM2518A0	SUPPORTO VENTOLA RAFF CRUS 20X20 H20	1.000	PZ	VN1179A1	VENTIL ASSIALE 40x40x20mm 12Vcc	1.000	PZ	VT1276A0	VETRO ESTERNO SER. XEVC-0511-E	1.000	PZ
					Code	Description	Qty	UOM																																													
					VM2274A0	BOCCOLA SCANALATA CORTA	1.000	PZ																																													
					VM2275A0	BOCCOLA LISCIA CORTA	1.000	PZ																																													
					VM2284A0	PROFILO SALVAGOCCE SERIE 750	1.000	PZ																																													
					VM2305A0	NOTTOLINO FISSAGGIO TAPPI PORTE MM	14.000	PZ																																													
					VM2312A0	TUBETTO SX SCARICO GOCCIOLATOI O MM	1.000	PZ																																													
					VM2314A0	TAPPINO GOCCIOLATOI O MM	1.000	PZ																																													
					VM2315A0	SUPPORTO SPINGI VETRO INT MM	3.000	PZ																																													
					VM2505A0	SUPPORTO PREMI VETRO INT MM PLUS	2.000	PZ																																													
					VM2518A0	SUPPORTO VENTOLA RAFF CRUS 20X20 H20	1.000	PZ																																													
					VN1179A1	VENTIL ASSIALE 40x40x20mm 12Vcc	1.000	PZ																																													
					VT1276A0	VETRO ESTERNO SER. XEVC-0511-E	1.000	PZ																																													
0B1109A	COLONNINA INTERNA DX PORTA XEVC-0511-E		KDR1325A	0511 ZERO RIGHT -M EXTERNAL DOOR	<table border="1"> <thead> <tr> <th>Code</th> <th>Description</th> <th>Qty</th> <th>UOM</th> </tr> </thead> <tbody> <tr> <td>0B1106A0</td> <td>COLONNINA ESTERNA SX PORTA XEVC-0511-E</td> <td>1.000</td> <td>PZ</td> </tr> <tr> <td>0B1107A1</td> <td>COLONNINA INTERNA SX PORTA XEVC-0511-E</td> <td>1.000</td> <td>PZ</td> </tr> <tr> <td>0B1108B1</td> <td>COLONNINA ESTERNA DX PORTA XEVC-0511</td> <td>1.000</td> <td>PZ</td> </tr> <tr> <td>0B1109A1</td> <td>COLONNINA INTERNA DX PORTA XEVC-0511-E</td> <td>1.000</td> <td>PZ</td> </tr> </tbody> </table>	Code	Description	Qty	UOM	0B1106A0	COLONNINA ESTERNA SX PORTA XEVC-0511-E	1.000	PZ	0B1107A1	COLONNINA INTERNA SX PORTA XEVC-0511-E	1.000	PZ	0B1108B1	COLONNINA ESTERNA DX PORTA XEVC-0511	1.000	PZ	0B1109A1	COLONNINA INTERNA DX PORTA XEVC-0511-E	1.000	PZ																												
					Code	Description	Qty	UOM																																													
					0B1106A0	COLONNINA ESTERNA SX PORTA XEVC-0511-E	1.000	PZ																																													
					0B1107A1	COLONNINA INTERNA SX PORTA XEVC-0511-E	1.000	PZ																																													
0B1108B1	COLONNINA ESTERNA DX PORTA XEVC-0511	1.000	PZ																																																		
0B1109A1	COLONNINA INTERNA DX PORTA XEVC-0511-E	1.000	PZ																																																		



COMPONENT			SPARE PART					
Code	Description	Image	Code	Description	Kit components			
0B1109A	COLONNINA INTERNA DX PORTA XEVC-0511-E		KDR1325A	0511 ZERO RIGHT -M EXTERNAL DOOR	Code	Description	Qty	UOM
					0B1122B0	TRAVERSO INFERIORE PORTA 750 MMc	1.000	PZ
					0B1166A1	PROFILO SUPPORTO VETRO EST XEVC-0511-E	2.000	PZ
					0B1216B0	TRAVERSO SUPERIORE PORTA 750 2V MMc	1.000	PZ
					0B1217A1	TRAVERSO SUPERIORE INT PORTA 750 S6 2V	1.000	PZ
					0H2892A0	LAMIERINO TAPPO SUP BARRA LED	1.000	PZ
					0H2893A0	LAMIERINO TAPPO INF BARRA LED	1.000	PZ
					CE1096A0	CAVO BUS MICROFIT 4POLI 3 M	1.000	PZ
					CE1285A0	FERRITE EMI ROUND MOD. 2643801502	2.000	PZ
					CE1851A0	CAVO Y MICROFIT 2P M-F-F AWG22	1.000	PZ
					CE2001A0	CAVO MICROFIT 2PM-100-2PM 2AWG22	1.000	PZ
					CE2002A0	CAVO MICROFIT 2PM-100-AMP MODU2 2AWG22	1.000	PZ
					GN1525A0	O-RING D.INT 9.5xSP 1 NBR 7	1.000	PZ
					LP1019A0	BARRA ILLUMINAZION E LED MM L200 E415	1.000	PZ
					MG1099A1	ASSIEME MANIGLIA COMPLETO MMc	1.000	PZ
					SL1170A1	SILICONE ANTRACITE S57 CARTUCCIA 310 ml	30.000	ML

COMPONENT			SPARE PART					
Code	Description	Image	Code	Description	Kit components			
0B1109A	COLONNINA INTERNA DX PORTA XEVC-0511-E		KDR1325A	0511 ZERO RIGHT -M EXTERNAL DOOR	Code	Description	Qty	UOM
					SL1221A0	SILICONE SUP VETRO EXT GN1/1	1.000	PZ
					SL1222A0	SILICONE LAT VETRO EXT 0511	4.000	PZ
					VE1030A1	CALAMITA D=22,9mm PER MICROPORTA	1.000	PZ
					VI1034A0	RONDELLA PIANA 8,4x16x1 INOX	1.000	PZ
					VI1074A0	VITE PER PLASTICA 4X16 TPBS+ INOX	1.000	PZ
					VI1174A0	VITE 5X20 PER PLASTICA ZN-NI	16.000	PZ
					VI1220A1	VITE AUTOFIL. 4,2X11 TCS+ MARUTEX	26.000	PZ
					VI1996A0	VITE M5x35 TCEI ZN	13.000	PZ
					VM1490A0	COPRI VITI MANIGLIA CHEFTOP BAKERTOP	2.000	PZ
					VM1630A1	TAPPO PREMI VETRO INTERNO	3.000	PZ
					VM1631A0	TAPPO PREMI VETRO INTERNO PLU	3.000	PZ
					VM2259B0	TAPPO INF SX PORTA S6	1.000	PZ
					VM2268A0	TAPPO COPRI CALAMITA PORTA	1.000	PZ
					VM2274A0	BOCCOLA SCANALATA CORTA	1.000	PZ
					VM2275A0	BOCCOLA LISCIA CORTA	1.000	PZ
					VM2284B0	PROFILO SALVAGOCCE SERIE 750	1.000	PZ
					VM2305A0	NOTTOLINO FISSAGGIO TAPPI PORTE MM	14.000	PZ
					VM2312A0	TUBETTO SX SCARICO GOCCIOLATOI O MM	1.000	PZ



COMPONENT			SPARE PART																																						
Code	Description	Image	Code	Description	Kit components																																				
0B1109A	COLONNINA INTERNA DX PORTA XEVC-0511-E		KDR1325A	0511 ZERO RIGHT -M EXTERNAL DOOR	<table border="1"> <thead> <tr> <th>Code</th> <th>Description</th> <th>Qty</th> <th>UOM</th> </tr> </thead> <tbody> <tr> <td>VM2314A0</td> <td>TAPPINO GOCCIOLATOI O MM</td> <td>1.000</td> <td>PZ</td> </tr> <tr> <td>VM2315B0</td> <td>SUPPORTO SPINGI VETRO INT MM -M</td> <td>3.000</td> <td>PZ</td> </tr> <tr> <td>VM2505B1</td> <td>SUPPORTO PREMI VETRO INT MM PLUS</td> <td>3.000</td> <td>PZ</td> </tr> <tr> <td>VM2956A0</td> <td>ASSEMBLATO TAPPO SUP DX PORTA MM -M</td> <td>1.000</td> <td>PZ</td> </tr> <tr> <td>VM2957A0</td> <td>ASSEMBLATO TAPPO INF DX PORTA MM -M</td> <td>1.000</td> <td>PZ</td> </tr> <tr> <td>VM2958A0</td> <td>ASSEMBLATO TAPPO SUP SX PORTA MM -M</td> <td>1.000</td> <td>PZ</td> </tr> <tr> <td>VP1080A0</td> <td>TAPPO SUP CERNIERA VETRO INTERNO INF</td> <td>1.000</td> <td>PZ</td> </tr> <tr> <td>VT1276A0</td> <td>VETRO ESTERNO SER. XEVC-0511-E</td> <td>1.000</td> <td>PZ</td> </tr> </tbody> </table>	Code	Description	Qty	UOM	VM2314A0	TAPPINO GOCCIOLATOI O MM	1.000	PZ	VM2315B0	SUPPORTO SPINGI VETRO INT MM -M	3.000	PZ	VM2505B1	SUPPORTO PREMI VETRO INT MM PLUS	3.000	PZ	VM2956A0	ASSEMBLATO TAPPO SUP DX PORTA MM -M	1.000	PZ	VM2957A0	ASSEMBLATO TAPPO INF DX PORTA MM -M	1.000	PZ	VM2958A0	ASSEMBLATO TAPPO SUP SX PORTA MM -M	1.000	PZ	VP1080A0	TAPPO SUP CERNIERA VETRO INTERNO INF	1.000	PZ	VT1276A0	VETRO ESTERNO SER. XEVC-0511-E	1.000	PZ
			Code	Description	Qty	UOM																																			
VM2314A0	TAPPINO GOCCIOLATOI O MM	1.000	PZ																																						
VM2315B0	SUPPORTO SPINGI VETRO INT MM -M	3.000	PZ																																						
VM2505B1	SUPPORTO PREMI VETRO INT MM PLUS	3.000	PZ																																						
VM2956A0	ASSEMBLATO TAPPO SUP DX PORTA MM -M	1.000	PZ																																						
VM2957A0	ASSEMBLATO TAPPO INF DX PORTA MM -M	1.000	PZ																																						
VM2958A0	ASSEMBLATO TAPPO SUP SX PORTA MM -M	1.000	PZ																																						
VP1080A0	TAPPO SUP CERNIERA VETRO INTERNO INF	1.000	PZ																																						
VT1276A0	VETRO ESTERNO SER. XEVC-0511-E	1.000	PZ																																						
KDR1269B	BT-04 -M EXTERNAL RIGHT DOOR	<table border="1"> <thead> <tr> <th>Code</th> <th>Description</th> <th>Qty</th> <th>UOM</th> </tr> </thead> <tbody> <tr> <td>0B1107A1</td> <td>COLONNINA INTERNA SX PORTA XEVC-0511-E</td> <td>1.000</td> <td>PZ</td> </tr> <tr> <td>0B1108B1</td> <td>COLONNINA ESTERNA DX PORTA XEVC-0511</td> <td>1.000</td> <td>PZ</td> </tr> <tr> <td>0B1109A1</td> <td>COLONNINA INTERNA DX PORTA XEVC-0511-E</td> <td>1.000</td> <td>PZ</td> </tr> <tr> <td>0B1126B0</td> <td>TRAVERSO INFERIORE PORTA 860 M</td> <td>1.000</td> <td>PZ</td> </tr> <tr> <td>0B1166A1</td> <td>PROFILO SUPPORTO VETRO EST XEVC-0511-E</td> <td>2.000</td> <td>PZ</td> </tr> <tr> <td>0B1174A0</td> <td>COLONNINA ESTERNA SX PORTA XEBC-04EU-E</td> <td>1.000</td> <td>PZ</td> </tr> </tbody> </table>	Code	Description	Qty	UOM	0B1107A1	COLONNINA INTERNA SX PORTA XEVC-0511-E	1.000	PZ	0B1108B1	COLONNINA ESTERNA DX PORTA XEVC-0511	1.000	PZ	0B1109A1	COLONNINA INTERNA DX PORTA XEVC-0511-E	1.000	PZ	0B1126B0	TRAVERSO INFERIORE PORTA 860 M	1.000	PZ	0B1166A1	PROFILO SUPPORTO VETRO EST XEVC-0511-E	2.000	PZ	0B1174A0	COLONNINA ESTERNA SX PORTA XEBC-04EU-E	1.000	PZ											
Code	Description	Qty	UOM																																						
0B1107A1	COLONNINA INTERNA SX PORTA XEVC-0511-E	1.000	PZ																																						
0B1108B1	COLONNINA ESTERNA DX PORTA XEVC-0511	1.000	PZ																																						
0B1109A1	COLONNINA INTERNA DX PORTA XEVC-0511-E	1.000	PZ																																						
0B1126B0	TRAVERSO INFERIORE PORTA 860 M	1.000	PZ																																						
0B1166A1	PROFILO SUPPORTO VETRO EST XEVC-0511-E	2.000	PZ																																						
0B1174A0	COLONNINA ESTERNA SX PORTA XEBC-04EU-E	1.000	PZ																																						

COMPONENT			SPARE PART					
Code	Description	Image	Code	Description	Kit components			
0B1109A	COLONNINA INTERNA DX PORTA XEVC-0511-E		KDR1269B	BT-04 -M EXTERNAL RIGHT DOOR	Code	Description	Qty	UOM
					0B1218B0	TRAVERSO SUPERIORE PORTA 860 2V MMc	1.000	PZ
					0B1219A1	TRAVERSO SUPERIORE INT PORTA 860 S6 2V	1.000	PZ
					CE1052A1	CAVO CONNESSIONE E CONTROLLO-USB MM 750m	1.000	PZ
					CE1053B0	CAVO ALIMENT BARRA LED MM MICROFIT 2P	1.000	PZ
					CE1097A0	CAVO BUS MICROFIT 4 POLI SIHF 4M	1.000	PZ
					CE1285A0	FERRITE EMI ROUND MOD. 2643801502	2.000	PZ
					LP1019A0	BARRA ILLUMINAZIONE LED MM L200 E415	1.000	PZ
					LP1025A0	ESTRUSO ILLUMINAZIONE NO LED MM L415	1.000	PZ
					MG1099A1	ASSIEME MANIGLIA COMPLETO MMc	1.000	PZ
					SL1170A1	SILICONE ANTRACITE S57 CARTUCCIA 310 ml	35.000	ML
					SL1222A0	SILICONE LAT VETRO EXT 0511	4.000	PZ
					SL1229A0	SILICONE SUP VETRO EXT BAKER	1.000	PZ
					VE1030A1	CALAMITA D=22,9mm PER MICROPORTA	1.000	PZ
					VI1074A0	VITE PER PLASTICA 4X16 TPBS+ INOX	4.000	PZ



COMPONENT			SPARE PART					
Code	Description	Image	Code	Description	Kit components			
0B1109A	COLONNINA INTERNA DX PORTA XEVC-0511-E		KDR1269B	BT-04 -M EXTERNAL RIGHT DOOR	Code	Description	Qty	UOM
					VI1103A0	VITE PER PLASTICA 4X12 TPBS+ ZN-NI	2.000	PZ
					VI1174A0	VITE 5X20 PER PLASTICA ZN-NI	16.000	PZ
					VI1220A1	VITE AUTOFIL. 4.2X11 TCS+ MARUTEX	28.000	PZ
					VI1996A0	VITE M5x35 TCEI ZN	13.000	PZ
					VM1490A0	COPRI VITI MANIGLIA CHEFTOP BAKERTOP	2.000	PZ
					VM1630A1	TAPPO PREMI VETRO INTERNO	3.000	PZ
					VM1631A0	TAPPO PREMI VETRO INTERNO PLU	3.000	PZ
					VM2259B0	TAPPO INF SX PORTA S6	1.000	PZ
					VM2268A0	TAPPO COPRI CALAMITA PORTA	1.000	PZ
					VM2274A0	BOCCOLA SCANALATA CORTA	1.000	PZ
					VM2275A0	BOCCOLA LISCIA CORTA	1.000	PZ
					VM2285B0	PROFILO SALVAGOCCE SERIE 860	1.000	PZ
					VM2305A0	NOTTOLINO FISSAGGIO TAPPI PORTE MM	14.000	PZ
					VM2312A0	TUBETTO SX SCARICO GOCCIOLATOI O MM	1.000	PZ
					VM2314A0	TAPPINO GOCCIOLATOI O MM	1.000	PZ
					VM2315B0	SUPPORTO SPINGI VETRO INT MM -M	3.000	PZ
VM2505B1	SUPPORTO PREMI VETRO INT MM PLUS	3.000	PZ					





COMPONENT			SPARE PART																																		
Code	Description	Image	Code	Description	Kit components																																
0B1109A	COLONNINA INTERNA DX PORTA XEVC-0511-E		KDR1269B	BT-04 -M EXTERNAL RIGHT DOOR	<table border="1"> <thead> <tr> <th>Code</th> <th>Description</th> <th>Qty</th> <th>UOM</th> </tr> </thead> <tbody> <tr> <td>VM2518A0</td> <td>SUPPORTO VENTOLA RAFF CRUS 20X20 H20</td> <td>1.000</td> <td>PZ</td> </tr> <tr> <td>VM3008A0</td> <td>ASSEMBLATO TAPPO SUP DX PORTA MM -MV</td> <td>1.000</td> <td>PZ</td> </tr> <tr> <td>VM3010A0</td> <td>ASSEMBLATO TAPPO INF DX PORTA MM -M</td> <td>1.000</td> <td>PZ</td> </tr> <tr> <td>VM3011A0</td> <td>ASSEMBLATO TAPPO SUP SX PORTA S6 -MV</td> <td>1.000</td> <td>PZ</td> </tr> <tr> <td>VN1179A1</td> <td>VENTIL ASSIALE 40x40x20mm 12Vcc</td> <td>1.000</td> <td>PZ</td> </tr> <tr> <td>VP1080A0</td> <td>TAPPO SUP CERNIERA VETRO INTERNO INF</td> <td>1.000</td> <td>PZ</td> </tr> <tr> <td>VT1290A0</td> <td>VETRO EST. SER. XEBC-04EU-E</td> <td>1.000</td> <td>PZ</td> </tr> </tbody> </table>	Code	Description	Qty	UOM	VM2518A0	SUPPORTO VENTOLA RAFF CRUS 20X20 H20	1.000	PZ	VM3008A0	ASSEMBLATO TAPPO SUP DX PORTA MM -MV	1.000	PZ	VM3010A0	ASSEMBLATO TAPPO INF DX PORTA MM -M	1.000	PZ	VM3011A0	ASSEMBLATO TAPPO SUP SX PORTA S6 -MV	1.000	PZ	VN1179A1	VENTIL ASSIALE 40x40x20mm 12Vcc	1.000	PZ	VP1080A0	TAPPO SUP CERNIERA VETRO INTERNO INF	1.000	PZ	VT1290A0	VETRO EST. SER. XEBC-04EU-E	1.000	PZ
			Code	Description	Qty	UOM																															
VM2518A0	SUPPORTO VENTOLA RAFF CRUS 20X20 H20	1.000	PZ																																		
VM3008A0	ASSEMBLATO TAPPO SUP DX PORTA MM -MV	1.000	PZ																																		
VM3010A0	ASSEMBLATO TAPPO INF DX PORTA MM -M	1.000	PZ																																		
VM3011A0	ASSEMBLATO TAPPO SUP SX PORTA S6 -MV	1.000	PZ																																		
VN1179A1	VENTIL ASSIALE 40x40x20mm 12Vcc	1.000	PZ																																		
VP1080A0	TAPPO SUP CERNIERA VETRO INTERNO INF	1.000	PZ																																		
VT1290A0	VETRO EST. SER. XEBC-04EU-E	1.000	PZ																																		
KDR1269A	BT-04 EXTERNAL RIGHT DOOR	<table border="1"> <thead> <tr> <th>Code</th> <th>Description</th> <th>Qty</th> <th>UOM</th> </tr> </thead> <tbody> <tr> <td>0B1107A1</td> <td>COLONNINA INTERNA SX PORTA XEVC-0511-E</td> <td>1.000</td> <td>PZ</td> </tr> <tr> <td>0B1108B1</td> <td>COLONNINA ESTERNA DX PORTA XEVC-0511</td> <td>1.000</td> <td>PZ</td> </tr> <tr> <td>0B1109A1</td> <td>COLONNINA INTERNA DX PORTA XEVC-0511-E</td> <td>1.000</td> <td>PZ</td> </tr> <tr> <td>0B1126A1</td> <td>TRAVERSO INFERIORE PORTA 860 M</td> <td>1.000</td> <td>PZ</td> </tr> <tr> <td>0B1166A1</td> <td>PROFILO SUPPORTO VETRO EST XEVC-0511-E</td> <td>2.000</td> <td>PZ</td> </tr> <tr> <td>0B1174A0</td> <td>COLONNINA ESTERNA SX PORTA XEBC-04EU-E</td> <td>1.000</td> <td>PZ</td> </tr> <tr> <td>0B1218A1</td> <td>TRAVERSO SUPERIORE PORTA 860 MM 2V</td> <td>1.000</td> <td>PZ</td> </tr> </tbody> </table>	Code	Description	Qty	UOM	0B1107A1	COLONNINA INTERNA SX PORTA XEVC-0511-E	1.000	PZ	0B1108B1	COLONNINA ESTERNA DX PORTA XEVC-0511	1.000	PZ	0B1109A1	COLONNINA INTERNA DX PORTA XEVC-0511-E	1.000	PZ	0B1126A1	TRAVERSO INFERIORE PORTA 860 M	1.000	PZ	0B1166A1	PROFILO SUPPORTO VETRO EST XEVC-0511-E	2.000	PZ	0B1174A0	COLONNINA ESTERNA SX PORTA XEBC-04EU-E	1.000	PZ	0B1218A1	TRAVERSO SUPERIORE PORTA 860 MM 2V	1.000	PZ			
Code	Description	Qty	UOM																																		
0B1107A1	COLONNINA INTERNA SX PORTA XEVC-0511-E	1.000	PZ																																		
0B1108B1	COLONNINA ESTERNA DX PORTA XEVC-0511	1.000	PZ																																		
0B1109A1	COLONNINA INTERNA DX PORTA XEVC-0511-E	1.000	PZ																																		
0B1126A1	TRAVERSO INFERIORE PORTA 860 M	1.000	PZ																																		
0B1166A1	PROFILO SUPPORTO VETRO EST XEVC-0511-E	2.000	PZ																																		
0B1174A0	COLONNINA ESTERNA SX PORTA XEBC-04EU-E	1.000	PZ																																		
0B1218A1	TRAVERSO SUPERIORE PORTA 860 MM 2V	1.000	PZ																																		

COMPONENT			SPARE PART					
Code	Description	Image	Code	Description	Kit components			
OB1109A	COLONNINA INTERNA DX PORTA XEVC-0511-E		KDR1269A	BT-04 EXTERNAL RIGHT DOOR	Code	Description	Qty	UOM
					0B1219A1	TRAVERSO SUPERIORE INT PORTA 860 S6 2V	1.000	PZ
					CE1052A1	CAVO CONNESSIONE CONTROLLO-USB MM 750m	1.000	PZ
					CE1053B0	CAVO ALIMENT BARRA LED MM MICROFIT 2P	1.000	PZ
					CE1285A0	FERRITE EMI ROUND MOD. 2643801502	1.000	PZ
					CE1290A0	MORSETTO FEMMINA ESTRAIBILE CPF 5/4	1.000	PZ
					CE1310A1	CAVO COLLEGAMEN TO POTENZA CONTROLLO L4 M	1.000	PZ
					LP1019A0	BARRA ILLUMINAZIONE LED MM L200 E415	1.000	PZ
					LP1025A0	ESTRUSO ILLUMINAZIONE NO LED MM L415	1.000	PZ
					MG1083A2	ASSIEME MANIGLIA COMPLETO M	1.000	PZ
					SL1170A1	SILICONE ANTRACITE S57 CARTUCCIA 310 ml	30.000	ML
					VE1030A1	CALAMITA D=22,9mm PER MICROPORTA	1.000	PZ
					V11147A0	VITE 5X25 TRUCIOLARE INOX	16.000	PZ
					V11220A1	VITE AUTOFIL 4.2X11 TCS+ MARUTEX	25.000	PZ
					V11996A0	VITE M5x35 TCEI ZN	13.000	PZ

COMPONENT			SPARE PART																																																																															
Code	Description	Image	Code	Description	Kit components																																																																													
OB1109A	COLONNINA INTERNA DX PORTA XEVC-0511-E		KDR1269A	BT-04 EXTERNAL RIGHT DOOR	<table border="1"> <thead> <tr> <th>Code</th> <th>Description</th> <th>Qty</th> <th>UOM</th> </tr> </thead> <tbody> <tr> <td>VM1630A1</td> <td>TAPPO PREMI VETRO INTERNO</td> <td>3.000</td> <td>PZ</td> </tr> <tr> <td>VM1631A0</td> <td>TAPPO PREMI VETRO INTERNO PLU</td> <td>2.000</td> <td>PZ</td> </tr> <tr> <td>VM2259A1</td> <td>TAPPO INF SX PORTA S6</td> <td>1.000</td> <td>PZ</td> </tr> <tr> <td>VM2260A1</td> <td>TAPPO SUP SX PORTA S6</td> <td>1.000</td> <td>PZ</td> </tr> <tr> <td>VM2261A1</td> <td>TAPPO INF DX PORTA MM</td> <td>1.000</td> <td>PZ</td> </tr> <tr> <td>VM2262A1</td> <td>TAPPO SUP DX PORTA MM</td> <td>1.000</td> <td>PZ</td> </tr> <tr> <td>VM2267A1</td> <td>CORSOIO SISTEMA FERMA VETRO INT</td> <td>2.000</td> <td>PZ</td> </tr> <tr> <td>VM2268A0</td> <td>TAPPO COPRI CALAMITA PORTA</td> <td>2.000</td> <td>PZ</td> </tr> <tr> <td>VM2269A0</td> <td>TAPPO SISTEMA FERMA VETRO INT</td> <td>2.000</td> <td>PZ</td> </tr> <tr> <td>VM2274A0</td> <td>BOCCOLA SCANALATA CORTA</td> <td>1.000</td> <td>PZ</td> </tr> <tr> <td>VM2275A0</td> <td>BOCCOLA LISCIA CORTA</td> <td>1.000</td> <td>PZ</td> </tr> <tr> <td>VM2285A0</td> <td>PROFILO SALVAGOCCE SERIE 860</td> <td>1.000</td> <td>PZ</td> </tr> <tr> <td>VM2305A0</td> <td>NOTTOLINO FISSAGGIO TAPPI PORTE MM</td> <td>14.000</td> <td>PZ</td> </tr> <tr> <td>VM2312A0</td> <td>TUBETTO SX SCARICO GOCCIOLATOI O MM</td> <td>1.000</td> <td>PZ</td> </tr> <tr> <td>VM2313A0</td> <td>TUBETTO DX SCARICO GOCCIOLATOI O MM</td> <td>1.000</td> <td>PZ</td> </tr> <tr> <td>VM2314A0</td> <td>TAPPINO GOCCIOLATOI O MM</td> <td>1.000</td> <td>PZ</td> </tr> <tr> <td>VM2315A0</td> <td>SUPPORTO SPINGI VETRO INT MM</td> <td>3.000</td> <td>PZ</td> </tr> <tr> <td>VM2505A0</td> <td>SUPPORTO PREMI VETRO INT MM PLUS</td> <td>2.000</td> <td>PZ</td> </tr> </tbody> </table>	Code	Description	Qty	UOM	VM1630A1	TAPPO PREMI VETRO INTERNO	3.000	PZ	VM1631A0	TAPPO PREMI VETRO INTERNO PLU	2.000	PZ	VM2259A1	TAPPO INF SX PORTA S6	1.000	PZ	VM2260A1	TAPPO SUP SX PORTA S6	1.000	PZ	VM2261A1	TAPPO INF DX PORTA MM	1.000	PZ	VM2262A1	TAPPO SUP DX PORTA MM	1.000	PZ	VM2267A1	CORSOIO SISTEMA FERMA VETRO INT	2.000	PZ	VM2268A0	TAPPO COPRI CALAMITA PORTA	2.000	PZ	VM2269A0	TAPPO SISTEMA FERMA VETRO INT	2.000	PZ	VM2274A0	BOCCOLA SCANALATA CORTA	1.000	PZ	VM2275A0	BOCCOLA LISCIA CORTA	1.000	PZ	VM2285A0	PROFILO SALVAGOCCE SERIE 860	1.000	PZ	VM2305A0	NOTTOLINO FISSAGGIO TAPPI PORTE MM	14.000	PZ	VM2312A0	TUBETTO SX SCARICO GOCCIOLATOI O MM	1.000	PZ	VM2313A0	TUBETTO DX SCARICO GOCCIOLATOI O MM	1.000	PZ	VM2314A0	TAPPINO GOCCIOLATOI O MM	1.000	PZ	VM2315A0	SUPPORTO SPINGI VETRO INT MM	3.000	PZ	VM2505A0	SUPPORTO PREMI VETRO INT MM PLUS	2.000	PZ	
Code	Description	Qty	UOM																																																																															
VM1630A1	TAPPO PREMI VETRO INTERNO	3.000	PZ																																																																															
VM1631A0	TAPPO PREMI VETRO INTERNO PLU	2.000	PZ																																																																															
VM2259A1	TAPPO INF SX PORTA S6	1.000	PZ																																																																															
VM2260A1	TAPPO SUP SX PORTA S6	1.000	PZ																																																																															
VM2261A1	TAPPO INF DX PORTA MM	1.000	PZ																																																																															
VM2262A1	TAPPO SUP DX PORTA MM	1.000	PZ																																																																															
VM2267A1	CORSOIO SISTEMA FERMA VETRO INT	2.000	PZ																																																																															
VM2268A0	TAPPO COPRI CALAMITA PORTA	2.000	PZ																																																																															
VM2269A0	TAPPO SISTEMA FERMA VETRO INT	2.000	PZ																																																																															
VM2274A0	BOCCOLA SCANALATA CORTA	1.000	PZ																																																																															
VM2275A0	BOCCOLA LISCIA CORTA	1.000	PZ																																																																															
VM2285A0	PROFILO SALVAGOCCE SERIE 860	1.000	PZ																																																																															
VM2305A0	NOTTOLINO FISSAGGIO TAPPI PORTE MM	14.000	PZ																																																																															
VM2312A0	TUBETTO SX SCARICO GOCCIOLATOI O MM	1.000	PZ																																																																															
VM2313A0	TUBETTO DX SCARICO GOCCIOLATOI O MM	1.000	PZ																																																																															
VM2314A0	TAPPINO GOCCIOLATOI O MM	1.000	PZ																																																																															
VM2315A0	SUPPORTO SPINGI VETRO INT MM	3.000	PZ																																																																															
VM2505A0	SUPPORTO PREMI VETRO INT MM PLUS	2.000	PZ																																																																															





COMPONENT			SPARE PART																																											
Code	Description	Image	Code	Description	Kit components																																									
OB1109A	COLONNINA INTERNA DX PORTA XEVC-0511-E		KDR1269A	BT-04 EXTERNAL RIGHT DOOR	<table border="1"> <thead> <tr> <th>Code</th> <th>Description</th> <th>Qty</th> <th>UOM</th> </tr> </thead> <tbody> <tr> <td>VM2518A0</td> <td>SUPPORTO VENTOLA RAFF CRUS 20X20 H20</td> <td>1.000</td> <td>PZ</td> </tr> <tr> <td>VN1179A1</td> <td>VENTIL ASSIALE 40x40x20mm 12Vcc</td> <td>1.000</td> <td>PZ</td> </tr> <tr> <td>VT1290A0</td> <td>VETRO EST. SER. XEBC-04EU-E</td> <td>1.000</td> <td>PZ</td> </tr> </tbody> </table>	Code	Description	Qty	UOM	VM2518A0	SUPPORTO VENTOLA RAFF CRUS 20X20 H20	1.000	PZ	VN1179A1	VENTIL ASSIALE 40x40x20mm 12Vcc	1.000	PZ	VT1290A0	VETRO EST. SER. XEBC-04EU-E	1.000	PZ																									
			Code	Description	Qty	UOM																																								
VM2518A0	SUPPORTO VENTOLA RAFF CRUS 20X20 H20	1.000	PZ																																											
VN1179A1	VENTIL ASSIALE 40x40x20mm 12Vcc	1.000	PZ																																											
VT1290A0	VETRO EST. SER. XEBC-04EU-E	1.000	PZ																																											
KDR1261B	0511 -M RIGHT EXTERNAL DOOR	<table border="1"> <thead> <tr> <th>Code</th> <th>Description</th> <th>Qty</th> <th>UOM</th> </tr> </thead> <tbody> <tr> <td>OB1106A0</td> <td>COLONNINA ESTERNA SX PORTA XEVC-0511-E</td> <td>1.000</td> <td>PZ</td> </tr> <tr> <td>OB1107A1</td> <td>COLONNINA INTERNA SX PORTA XEVC-0511-E</td> <td>1.000</td> <td>PZ</td> </tr> <tr> <td>OB1108B1</td> <td>COLONNINA ESTERNA DX PORTA XEVC-0511</td> <td>1.000</td> <td>PZ</td> </tr> <tr> <td>OB1109A1</td> <td>COLONNINA INTERNA DX PORTA XEVC-0511-E</td> <td>1.000</td> <td>PZ</td> </tr> <tr> <td>OB1122B0</td> <td>TRAVERSO INFERIORE PORTA 750 MMc</td> <td>1.000</td> <td>PZ</td> </tr> <tr> <td>OB1166A1</td> <td>PROFILO SUPPORTO VETRO EST XEVC-0511-E</td> <td>2.000</td> <td>PZ</td> </tr> <tr> <td>OB1216B0</td> <td>TRAVERSO SUPERIORE PORTA 750 2V MMc</td> <td>1.000</td> <td>PZ</td> </tr> <tr> <td>OB1217A1</td> <td>TRAVERSO SUPERIORE INT PORTA 750 S6 2V</td> <td>1.000</td> <td>PZ</td> </tr> <tr> <td>CE1052A1</td> <td>CAVO CONNESSION E CONTROLLO- USB MM 750m</td> <td>1.000</td> <td>PZ</td> </tr> <tr> <td>CE1053B0</td> <td>CAVO ALIMENT BARRA LED MM MICROFIT 2P</td> <td>1.000</td> <td>PZ</td> </tr> </tbody> </table>	Code	Description	Qty	UOM	OB1106A0	COLONNINA ESTERNA SX PORTA XEVC-0511-E	1.000	PZ	OB1107A1	COLONNINA INTERNA SX PORTA XEVC-0511-E	1.000	PZ	OB1108B1	COLONNINA ESTERNA DX PORTA XEVC-0511	1.000	PZ	OB1109A1	COLONNINA INTERNA DX PORTA XEVC-0511-E	1.000	PZ	OB1122B0	TRAVERSO INFERIORE PORTA 750 MMc	1.000	PZ	OB1166A1	PROFILO SUPPORTO VETRO EST XEVC-0511-E	2.000	PZ	OB1216B0	TRAVERSO SUPERIORE PORTA 750 2V MMc	1.000	PZ	OB1217A1	TRAVERSO SUPERIORE INT PORTA 750 S6 2V	1.000	PZ	CE1052A1	CAVO CONNESSION E CONTROLLO- USB MM 750m	1.000	PZ	CE1053B0	CAVO ALIMENT BARRA LED MM MICROFIT 2P	1.000	PZ
Code	Description	Qty	UOM																																											
OB1106A0	COLONNINA ESTERNA SX PORTA XEVC-0511-E	1.000	PZ																																											
OB1107A1	COLONNINA INTERNA SX PORTA XEVC-0511-E	1.000	PZ																																											
OB1108B1	COLONNINA ESTERNA DX PORTA XEVC-0511	1.000	PZ																																											
OB1109A1	COLONNINA INTERNA DX PORTA XEVC-0511-E	1.000	PZ																																											
OB1122B0	TRAVERSO INFERIORE PORTA 750 MMc	1.000	PZ																																											
OB1166A1	PROFILO SUPPORTO VETRO EST XEVC-0511-E	2.000	PZ																																											
OB1216B0	TRAVERSO SUPERIORE PORTA 750 2V MMc	1.000	PZ																																											
OB1217A1	TRAVERSO SUPERIORE INT PORTA 750 S6 2V	1.000	PZ																																											
CE1052A1	CAVO CONNESSION E CONTROLLO- USB MM 750m	1.000	PZ																																											
CE1053B0	CAVO ALIMENT BARRA LED MM MICROFIT 2P	1.000	PZ																																											

COMPONENT			SPARE PART					
Code	Description	Image	Code	Description	Kit components			
0B1109A	COLONNINA INTERNA DX PORTA XEVC-0511-E		KDR1261B	0511 -M RIGHT EXTERNAL DOOR	Code	Description	Qty	UOM
					CE1096A0	CAVO BUS MICROFIT 4POLI 3 M	1.000	PZ
					CE1285A0	FERRITE EMI ROUND MOD. 2643801502	2.000	PZ
					GN1525A0	O-RING D.INT 9.5xSP 1 NBR 7	1.000	PZ
					LP1019A0	BARRA ILLUMINAZION E LED MM L200 E415	1.000	PZ
					LP1025A0	ESTRUSO ILLUMINAZION E NO LED MM L415	1.000	PZ
					MG1099A1	ASSIEME MANIGLIA COMPLETO MMc	1.000	PZ
					SL1170A1	SILICONE ANTRACITE S57 CARTUCCIA 310 ml	30.000	ML
					SL1221A0	SILICONE SUP VETRO EXT GN1/1	1.000	PZ
					SL1222A0	SILICONE LAT VETRO EXT 0511	4.000	PZ
					VE1030A1	CALAMITA D=22,9mm PER MICROPORTA	1.000	PZ
					VI1034A0	RONDELLA PIANA 8.4x16x1 INOX	1.000	PZ
					VI1074A0	VITE PER PLASTICA 4X16 TPBS+ INOX	1.000	PZ
					VI1174A0	VITE 5X20 PER PLASTICA ZN-NI	16.000	PZ
					VI1220A1	VITE AUTOFIL. 4.2X11 TCS+ MARUTEX	26.000	PZ
					VI1996A0	VITE M5x35 TCEI ZN	13.000	PZ
VM1490A0	COPRI VITI MANIGLIA CHEFTOP BAKERTOP	2.000	PZ					



COMPONENT			SPARE PART					
Code	Description	Image	Code	Description	Kit components			
0B1109A	COLONNINA INTERNA DX PORTA XEVC-0511-E		KDR1261B	0511 -M RIGHT EXTERNAL DOOR	Code	Description	Qty	UOM
					VM1630A1	TAPPO PREMI VETRO INTERNO	3.000	PZ
					VM1631A0	TAPPO PREMI VETRO INTERNO PLU	3.000	PZ
					VM2259B0	TAPPO INF SX PORTA S6	1.000	PZ
					VM2268A0	TAPPO COPRI CALAMITA PORTA	1.000	PZ
					VM2274A0	BOCCOLA SCANALATA CORTA	1.000	PZ
					VM2275A0	BOCCOLA LISCIA CORTA	1.000	PZ
					VM2284B0	PROFILO SALVAGOCCE SERIE 750	1.000	PZ
					VM2305A0	NOTTOLINO FISSAGGIO TAPPI PORTE MM	14.000	PZ
					VM2312A0	TUBETTO SX SCARICO GOCCIOLATOI O MM	1.000	PZ
					VM2314A0	TAPPINO GOCCIOLATOI O MM	1.000	PZ
					VM2315B0	SUPPORTO SPINGI VETRO INT MM -M	3.000	PZ
					VM2505B1	SUPPORTO PREMI VETRO INT MM PLUS	3.000	PZ
					VM3008A0	ASSEMBLATO TAPPO SUP DX PORTA MM -MV	1.000	PZ
					VM3010A0	ASSEMBLATO TAPPO INF DX PORTA MM -M	1.000	PZ
					VM3011A0	ASSEMBLATO TAPPO SUP SX PORTA S6 -MV	1.000	PZ
					VP1080A0	TAPPO SUP CERNIERA VETRO INTERNO INF	1.000	PZ
					VT1276A0	VETRO ESTERNO SER. XEVC-0511-E	1.000	PZ

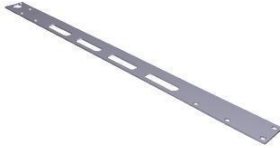

COMPONENT			SPARE PART					
Code	Description	Image	Code	Description	Kit components			
0B1109A	COLONNINA INTERNA DX PORTA XEVC-0511-E		KDR1261A	0511 RIGHT EXTERNAL DOOR	Code	Description	Qty	UOM
					0B1106A0	COLONNINA ESTERNA SX PORTA XEVC-0511-E	1.000	PZ
					0B1107A1	COLONNINA INTERNA SX PORTA XEVC-0511-E	1.000	PZ
					0B1108B1	COLONNINA ESTERNA DX PORTA XEVC-0511	1.000	PZ
					0B1109A1	COLONNINA INTERNA DX PORTA XEVC-0511-E	1.000	PZ
					0B1122A1	TRAVERSO INFERIORE PORTA 750 S6	1.000	PZ
					0B1166A1	PROFILO SUPPORTO VETRO EST XEVC-0511-E	2.000	PZ
					0B1216A1	TRAVERSO SUPERIORE PORTA 750mm MM 2V	1.000	PZ
					0B1217A1	TRAVERSO SUPERIORE INT PORTA 750 S6 2V	1.000	PZ
					CE1052A1	CAVO CONNESSION E CONTROLLO- USB MM 750m	1.000	PZ
					CE1053B0	CAVO ALIMENT BARRA LED MM MICROFIT 2P	1.000	PZ
					CE1275A0	CAVO COLLEGAMEN TO POTENZA CONTROLLO 3 M	1.000	PZ
					CE1285A0	FERRITE EMI ROUND MOD. 2643801502	1.000	PZ
					CE1290A0	MORSETTO FEMMINA ESTRAIBILE CPF 5/4	1.000	PZ
GN1525A0	O-RING D.INT 9.5xSP 1 NBR 7	1.000	PZ					

COMPONENT			SPARE PART					
Code	Description	Image	Code	Description	Kit components			
OB1109A	COLONNINA INTERNA DX PORTA XEVC-0511-E		KDR1261A	0511 RIGHT EXTERNAL DOOR	Code	Description	Qty	UOM
					LP1019A0	BARRA ILLUMINAZION E LED MM L200 E415	1.000	PZ
					LP1025A0	ESTRUSO ILLUMINAZION E NO LED MM L415	1.000	PZ
					MG1083A2	ASSIEME MANIGLIA COMPLETO M	1.000	PZ
					SL1170A1	SILICONE ANTRACITE S57 CARTUCCIA 310 ml	30.000	ML
					VE1030A1	CALAMITA D=22,9mm PER MICROPORTA	1.000	PZ
					V11034A0	RONDELLA PIANA 8.4x16x1 INOX	1.000	PZ
					V11147A0	VITE 5X25 TRUCIOLARE INOX	16.000	PZ
					V11220A1	VITE AUTOFIL. 4.2X11 TCS+ MARUTEX	25.000	PZ
					V11996A0	VITE M5x35 TCEI ZN	13.000	PZ
					VM1630A1	TAPPO PREMI VETRO INTERNO	3.000	PZ
					VM1631A0	TAPPO PREMI VETRO INTERNO PLU	2.000	PZ
					VM2259A1	TAPPO INF SX PORTA S6	1.000	PZ
					VM2260A1	TAPPO SUP SX PORTA S6	1.000	PZ
					VM2261A1	TAPPO INF DX PORTA MM	1.000	PZ
					VM2262A1	TAPPO SUP DX PORTA MM	1.000	PZ
					VM2267A1	CORSOIO SISTEMA FERMA VETRO INT	2.000	PZ
					VM2268A0	TAPPO COPRI CALAMITA PORTA	2.000	PZ
					VM2269A0	TAPPO SISTEMA FERMA VETRO INT	2.000	PZ

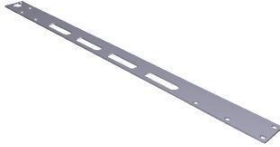
COMPONENT			SPARE PART																																																		
Code	Description	Image	Code	Description	Kit components																																																
0B1109A	COLONNINA INTERNA DX PORTA XEVC-0511-E		KDR1261A	0511 RIGHT EXTERNAL DOOR	<table border="1"> <thead> <tr> <th>Code</th> <th>Description</th> <th>Qty</th> <th>UOM</th> </tr> </thead> <tbody> <tr> <td>VM2274A0</td> <td>BOCCOLA SCANALATA CORTA</td> <td>1.000</td> <td>PZ</td> </tr> <tr> <td>VM2275A0</td> <td>BOCCOLA LISCIA CORTA</td> <td>1.000</td> <td>PZ</td> </tr> <tr> <td>VM2284A0</td> <td>PROFILO SALVAGOCCE SERIE 750</td> <td>1.000</td> <td>PZ</td> </tr> <tr> <td>VM2305A0</td> <td>NOTTOLINO FISSAGGIO TAPPI PORTE MM</td> <td>14.000</td> <td>PZ</td> </tr> <tr> <td>VM2312A0</td> <td>TUBETTO SX SCARICO GOCCIOLATOI O MM</td> <td>1.000</td> <td>PZ</td> </tr> <tr> <td>VM2314A0</td> <td>TAPPINO GOCCIOLATOI O MM</td> <td>1.000</td> <td>PZ</td> </tr> <tr> <td>VM2315A0</td> <td>SUPPORTO SPINGI VETRO INT MM</td> <td>3.000</td> <td>PZ</td> </tr> <tr> <td>VM2505A0</td> <td>SUPPORTO PREMI VETRO INT MM PLUS</td> <td>2.000</td> <td>PZ</td> </tr> <tr> <td>VM2518A0</td> <td>SUPPORTO VENTOLA RAFF CRUS 20X20 H20</td> <td>1.000</td> <td>PZ</td> </tr> <tr> <td>VN1179A1</td> <td>VENTIL ASSIALE 40x40x20mm 12Vcc</td> <td>1.000</td> <td>PZ</td> </tr> <tr> <td>VT1276A0</td> <td>VETRO ESTERNO SER. XEVC-0511-E</td> <td>1.000</td> <td>PZ</td> </tr> </tbody> </table>	Code	Description	Qty	UOM	VM2274A0	BOCCOLA SCANALATA CORTA	1.000	PZ	VM2275A0	BOCCOLA LISCIA CORTA	1.000	PZ	VM2284A0	PROFILO SALVAGOCCE SERIE 750	1.000	PZ	VM2305A0	NOTTOLINO FISSAGGIO TAPPI PORTE MM	14.000	PZ	VM2312A0	TUBETTO SX SCARICO GOCCIOLATOI O MM	1.000	PZ	VM2314A0	TAPPINO GOCCIOLATOI O MM	1.000	PZ	VM2315A0	SUPPORTO SPINGI VETRO INT MM	3.000	PZ	VM2505A0	SUPPORTO PREMI VETRO INT MM PLUS	2.000	PZ	VM2518A0	SUPPORTO VENTOLA RAFF CRUS 20X20 H20	1.000	PZ	VN1179A1	VENTIL ASSIALE 40x40x20mm 12Vcc	1.000	PZ	VT1276A0	VETRO ESTERNO SER. XEVC-0511-E	1.000	PZ
					Code	Description	Qty	UOM																																													
					VM2274A0	BOCCOLA SCANALATA CORTA	1.000	PZ																																													
					VM2275A0	BOCCOLA LISCIA CORTA	1.000	PZ																																													
					VM2284A0	PROFILO SALVAGOCCE SERIE 750	1.000	PZ																																													
					VM2305A0	NOTTOLINO FISSAGGIO TAPPI PORTE MM	14.000	PZ																																													
					VM2312A0	TUBETTO SX SCARICO GOCCIOLATOI O MM	1.000	PZ																																													
					VM2314A0	TAPPINO GOCCIOLATOI O MM	1.000	PZ																																													
					VM2315A0	SUPPORTO SPINGI VETRO INT MM	3.000	PZ																																													
					VM2505A0	SUPPORTO PREMI VETRO INT MM PLUS	2.000	PZ																																													
					VM2518A0	SUPPORTO VENTOLA RAFF CRUS 20X20 H20	1.000	PZ																																													
					VN1179A1	VENTIL ASSIALE 40x40x20mm 12Vcc	1.000	PZ																																													
					VT1276A0	VETRO ESTERNO SER. XEVC-0511-E	1.000	PZ																																													
0B1122B	TRAVERSO INFERIORE PORTA 750 MMc		K0B1122BR	CHEFTOP MM -M RIGHT DOOR LOWER BEAM KIT	<table border="1"> <thead> <tr> <th>Code</th> <th>Description</th> <th>Qty</th> <th>UOM</th> </tr> </thead> <tbody> <tr> <td>0B1122B0</td> <td>TRAVERSO INFERIORE PORTA 750 MMc</td> <td>1.000</td> <td>PZ</td> </tr> <tr> <td>VE1030A1</td> <td>CALAMITA D=22,9mm PER MICROPORTA</td> <td>1.000</td> <td>PZ</td> </tr> <tr> <td>VI1074A0</td> <td>VITE PER PLASTICA 4X16 TPBS+ INOX</td> <td>1.000</td> <td>PZ</td> </tr> <tr> <td>VI1174A0</td> <td>VITE 5X20 PER PLASTICA ZN-NI</td> <td>8.000</td> <td>PZ</td> </tr> </tbody> </table>	Code	Description	Qty	UOM	0B1122B0	TRAVERSO INFERIORE PORTA 750 MMc	1.000	PZ	VE1030A1	CALAMITA D=22,9mm PER MICROPORTA	1.000	PZ	VI1074A0	VITE PER PLASTICA 4X16 TPBS+ INOX	1.000	PZ	VI1174A0	VITE 5X20 PER PLASTICA ZN-NI	8.000	PZ																												
					Code	Description	Qty	UOM																																													
					0B1122B0	TRAVERSO INFERIORE PORTA 750 MMc	1.000	PZ																																													
					VE1030A1	CALAMITA D=22,9mm PER MICROPORTA	1.000	PZ																																													
VI1074A0	VITE PER PLASTICA 4X16 TPBS+ INOX	1.000	PZ																																																		
VI1174A0	VITE 5X20 PER PLASTICA ZN-NI	8.000	PZ																																																		

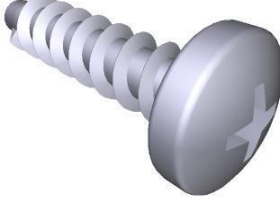
COMPONENT			SPARE PART																																											
Code	Description	Image	Code	Description	Kit components																																									
0B1122B	TRAVERSO INFERIORE PORTA 750 MMc		K0B1122BR	CHEFTOP MM -M RIGHT DOOR LOWER BEAM KIT	<table border="1"> <thead> <tr> <th>Code</th> <th>Description</th> <th>Qty</th> <th>UOM</th> </tr> </thead> <tbody> <tr> <td>VI1220A1</td> <td>VITE AUTOFIL. 4.2X11 TCS+ MARUTEX</td> <td>1.000</td> <td>PZ</td> </tr> <tr> <td>VI1996A0</td> <td>VITE M5x35 TCEI ZN</td> <td>7.000</td> <td>PZ</td> </tr> <tr> <td>VM1794A0</td> <td>FASCETTA 430X4.8 PA66 NERA</td> <td>2.000</td> <td>PZ</td> </tr> <tr> <td>VM2259B0</td> <td>TAPPO INF SX PORTA S6</td> <td>1.000</td> <td>PZ</td> </tr> <tr> <td>VM2268A0</td> <td>TAPPO COPRI PORTA</td> <td>1.000</td> <td>PZ</td> </tr> <tr> <td>VM2274A0</td> <td>BOCCOLA SCANALATA CORTA</td> <td>1.000</td> <td>PZ</td> </tr> <tr> <td>VM2305A0</td> <td>NOTTOLINO FISSAGGIO TAPPI PORTE MM</td> <td>7.000</td> <td>PZ</td> </tr> <tr> <td>VM3010A0</td> <td>ASSEMBLATO TAPPO INF DX PORTA MM -M</td> <td>1.000</td> <td>PZ</td> </tr> <tr> <td>VP1080A0</td> <td>TAPPO SUP CERNIERA VETRO INTERNO INF</td> <td>1.000</td> <td>PZ</td> </tr> </tbody> </table>	Code	Description	Qty	UOM	VI1220A1	VITE AUTOFIL. 4.2X11 TCS+ MARUTEX	1.000	PZ	VI1996A0	VITE M5x35 TCEI ZN	7.000	PZ	VM1794A0	FASCETTA 430X4.8 PA66 NERA	2.000	PZ	VM2259B0	TAPPO INF SX PORTA S6	1.000	PZ	VM2268A0	TAPPO COPRI PORTA	1.000	PZ	VM2274A0	BOCCOLA SCANALATA CORTA	1.000	PZ	VM2305A0	NOTTOLINO FISSAGGIO TAPPI PORTE MM	7.000	PZ	VM3010A0	ASSEMBLATO TAPPO INF DX PORTA MM -M	1.000	PZ	VP1080A0	TAPPO SUP CERNIERA VETRO INTERNO INF	1.000	PZ	
			Code	Description	Qty	UOM																																								
VI1220A1	VITE AUTOFIL. 4.2X11 TCS+ MARUTEX	1.000	PZ																																											
VI1996A0	VITE M5x35 TCEI ZN	7.000	PZ																																											
VM1794A0	FASCETTA 430X4.8 PA66 NERA	2.000	PZ																																											
VM2259B0	TAPPO INF SX PORTA S6	1.000	PZ																																											
VM2268A0	TAPPO COPRI PORTA	1.000	PZ																																											
VM2274A0	BOCCOLA SCANALATA CORTA	1.000	PZ																																											
VM2305A0	NOTTOLINO FISSAGGIO TAPPI PORTE MM	7.000	PZ																																											
VM3010A0	ASSEMBLATO TAPPO INF DX PORTA MM -M	1.000	PZ																																											
VP1080A0	TAPPO SUP CERNIERA VETRO INTERNO INF	1.000	PZ																																											
			K0B1122BL	CHEFTOP MM -M LEFT DOOR LOWER BEAM KIT	<table border="1"> <thead> <tr> <th>Code</th> <th>Description</th> <th>Qty</th> <th>UOM</th> </tr> </thead> <tbody> <tr> <td>0B1122B0</td> <td>TRAVERSO INFERIORE PORTA 750 MMc</td> <td>1.000</td> <td>PZ</td> </tr> <tr> <td>VE1030A1</td> <td>CALAMITA D=22,9mm PER MICROPORTA</td> <td>1.000</td> <td>PZ</td> </tr> <tr> <td>VI1074A0</td> <td>VITE PER PLASTICA 4X16 TPBS+ INOX</td> <td>1.000</td> <td>PZ</td> </tr> <tr> <td>VI1174A0</td> <td>VITE 5X20 PER PLASTICA ZN-NI</td> <td>8.000</td> <td>PZ</td> </tr> <tr> <td>VI1220A1</td> <td>VITE AUTOFIL. 4.2X11 TCS+ MARUTEX</td> <td>1.000</td> <td>PZ</td> </tr> <tr> <td>VI1996A0</td> <td>VITE M5x35 TCEI ZN</td> <td>6.000</td> <td>PZ</td> </tr> <tr> <td>VM1794A0</td> <td>FASCETTA 430X4.8 PA66 NERA</td> <td>2.000</td> <td>PZ</td> </tr> <tr> <td>VM2274A0</td> <td>BOCCOLA SCANALATA CORTA</td> <td>1.000</td> <td>PZ</td> </tr> </tbody> </table>	Code	Description	Qty	UOM	0B1122B0	TRAVERSO INFERIORE PORTA 750 MMc	1.000	PZ	VE1030A1	CALAMITA D=22,9mm PER MICROPORTA	1.000	PZ	VI1074A0	VITE PER PLASTICA 4X16 TPBS+ INOX	1.000	PZ	VI1174A0	VITE 5X20 PER PLASTICA ZN-NI	8.000	PZ	VI1220A1	VITE AUTOFIL. 4.2X11 TCS+ MARUTEX	1.000	PZ	VI1996A0	VITE M5x35 TCEI ZN	6.000	PZ	VM1794A0	FASCETTA 430X4.8 PA66 NERA	2.000	PZ	VM2274A0	BOCCOLA SCANALATA CORTA	1.000	PZ					
Code	Description	Qty	UOM																																											
0B1122B0	TRAVERSO INFERIORE PORTA 750 MMc	1.000	PZ																																											
VE1030A1	CALAMITA D=22,9mm PER MICROPORTA	1.000	PZ																																											
VI1074A0	VITE PER PLASTICA 4X16 TPBS+ INOX	1.000	PZ																																											
VI1174A0	VITE 5X20 PER PLASTICA ZN-NI	8.000	PZ																																											
VI1220A1	VITE AUTOFIL. 4.2X11 TCS+ MARUTEX	1.000	PZ																																											
VI1996A0	VITE M5x35 TCEI ZN	6.000	PZ																																											
VM1794A0	FASCETTA 430X4.8 PA66 NERA	2.000	PZ																																											
VM2274A0	BOCCOLA SCANALATA CORTA	1.000	PZ																																											

COMPONENT			SPARE PART																						
Code	Description	Image	Code	Description	Kit components																				
0B1122B	TRAVERSO INFERIORE PORTA 750 MMc		K0B1122BL	CHEFTOP MM -M LEFT DOOR LOWER BEAM KIT	<table border="1"> <thead> <tr> <th>Code</th> <th>Description</th> <th>Qty</th> <th>UOM</th> </tr> </thead> <tbody> <tr> <td>VM2305A0</td> <td>NOTTOLINO FISSAGGIO TAPPI PORTE MM</td> <td>7.000</td> <td>PZ</td> </tr> <tr> <td>VM2384B0</td> <td>TAPPO INF DX PORTA MM LEFT</td> <td>1.000</td> <td>PZ</td> </tr> <tr> <td>VM3014A0</td> <td>ASSEMBLATO TAPPO INF SX PORTA S6 LEFT-M</td> <td>1.000</td> <td>PZ</td> </tr> <tr> <td>VP1081A0</td> <td>TAPPO SUP CERNIERA VETRO INTERNO SUP</td> <td>1.000</td> <td>PZ</td> </tr> </tbody> </table>	Code	Description	Qty	UOM	VM2305A0	NOTTOLINO FISSAGGIO TAPPI PORTE MM	7.000	PZ	VM2384B0	TAPPO INF DX PORTA MM LEFT	1.000	PZ	VM3014A0	ASSEMBLATO TAPPO INF SX PORTA S6 LEFT-M	1.000	PZ	VP1081A0	TAPPO SUP CERNIERA VETRO INTERNO SUP	1.000	PZ
Code	Description	Qty	UOM																						
VM2305A0	NOTTOLINO FISSAGGIO TAPPI PORTE MM	7.000	PZ																						
VM2384B0	TAPPO INF DX PORTA MM LEFT	1.000	PZ																						
VM3014A0	ASSEMBLATO TAPPO INF SX PORTA S6 LEFT-M	1.000	PZ																						
VP1081A0	TAPPO SUP CERNIERA VETRO INTERNO SUP	1.000	PZ																						
0B1216B	TRAVERSO SUPERIORE PORTA 750 2V MMc		0B1216B0	TRAVERSO SUPERIORE PORTA 750 2V MMc																					
0B1217A	TRAVERSO SUPERIORE INT PORTA 750 S6 2V		OUTOFPRODUCTIO	ITEM OUT OF PRODUCTION																					
VI1174A	VITE 5X20 PER PLASTICA ZN-NI		VI1174A0	VITE 5X20 PER PLASTICA ZN-NI																					

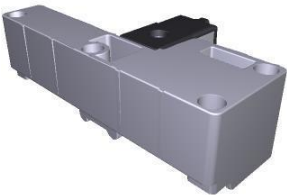
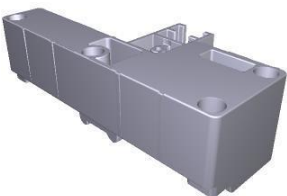
COMPONENT			SPARE PART																																		
Code	Description	Image	Code	Description	Kit components																																
VI1996A	VITE M5x35 TCEI ZN		VI1996A0	VITE M5x35 TCEI ZN																																	
VM2305A	NOTTOLINO FISSAGGIO TAPPI PORTE MM		KVM2305A	MM FIXING DOOR THUB SCREWS 10 PCS KIT	<table border="1"> <thead> <tr> <th>Code</th> <th>Description</th> <th>Qty</th> <th>UOM</th> </tr> </thead> <tbody> <tr> <td>VM2305A0</td> <td>NOTTOLINO FISSAGGIO TAPPI PORTE MM</td> <td>10.000</td> <td>PZ</td> </tr> </tbody> </table>	Code	Description	Qty	UOM	VM2305A0	NOTTOLINO FISSAGGIO TAPPI PORTE MM	10.000	PZ																								
Code	Description	Qty	UOM																																		
VM2305A0	NOTTOLINO FISSAGGIO TAPPI PORTE MM	10.000	PZ																																		
VM2956A	ASSEMBLATO TAPPO SUP DX PORTA MM -M		KVM2262B	MIND.MAPS -M DOOR RIGHT UPPER CAP KIT	<table border="1"> <thead> <tr> <th>Code</th> <th>Description</th> <th>Qty</th> <th>UOM</th> </tr> </thead> <tbody> <tr> <td>VE1030A1</td> <td>CALAMITA D=22,9mm PER MICROPORTA</td> <td>1.000</td> <td>PZ</td> </tr> <tr> <td>VI1220A1</td> <td>VITE AUTOFIL. 4.2X11 TCS+ MARUTEX</td> <td>1.000</td> <td>PZ</td> </tr> <tr> <td>VI1930A1</td> <td>VITE 5X20 TRUCIOLARE INOX</td> <td>4.000</td> <td>PZ</td> </tr> <tr> <td>VI1996A0</td> <td>VITE M5x35 TCEI ZN</td> <td>4.000</td> <td>PZ</td> </tr> <tr> <td>VM2268A0</td> <td>TAPPO COPRI CALAMITA PORTA</td> <td>1.000</td> <td>PZ</td> </tr> <tr> <td>VM2305A0</td> <td>NOTTOLINO FISSAGGIO TAPPI PORTE MM</td> <td>4.000</td> <td>PZ</td> </tr> <tr> <td>VM2956A0</td> <td>ASSEMBLATO TAPPO SUP DX PORTA MM -M</td> <td>1.000</td> <td>PZ</td> </tr> </tbody> </table>	Code	Description	Qty	UOM	VE1030A1	CALAMITA D=22,9mm PER MICROPORTA	1.000	PZ	VI1220A1	VITE AUTOFIL. 4.2X11 TCS+ MARUTEX	1.000	PZ	VI1930A1	VITE 5X20 TRUCIOLARE INOX	4.000	PZ	VI1996A0	VITE M5x35 TCEI ZN	4.000	PZ	VM2268A0	TAPPO COPRI CALAMITA PORTA	1.000	PZ	VM2305A0	NOTTOLINO FISSAGGIO TAPPI PORTE MM	4.000	PZ	VM2956A0	ASSEMBLATO TAPPO SUP DX PORTA MM -M	1.000	PZ
Code	Description	Qty	UOM																																		
VE1030A1	CALAMITA D=22,9mm PER MICROPORTA	1.000	PZ																																		
VI1220A1	VITE AUTOFIL. 4.2X11 TCS+ MARUTEX	1.000	PZ																																		
VI1930A1	VITE 5X20 TRUCIOLARE INOX	4.000	PZ																																		
VI1996A0	VITE M5x35 TCEI ZN	4.000	PZ																																		
VM2268A0	TAPPO COPRI CALAMITA PORTA	1.000	PZ																																		
VM2305A0	NOTTOLINO FISSAGGIO TAPPI PORTE MM	4.000	PZ																																		
VM2956A0	ASSEMBLATO TAPPO SUP DX PORTA MM -M	1.000	PZ																																		
VM2262B	VM2262B1		OUTOFPRODUCTIO	ITEM OUT OF PRODUCTION																																	

COMPONENT			SPARE PART																																		
Code	Description	Image	Code	Description	Kit components																																
VM2267A	CORSOIO SISTEMA FERMA VETRO INT		KVM2386B	MM -M LEFT DOOR LEFT LOWER CAP KI	<table border="1"> <thead> <tr> <th>Code</th> <th>Description</th> <th>Qty</th> <th>UOM</th> </tr> </thead> <tbody> <tr> <td>VE1030A1</td> <td>CALAMITA D=22,9mm PER MICROPORTA</td> <td>1.000</td> <td>PZ</td> </tr> <tr> <td>VI1220A1</td> <td>VITE AUTOFIL. 4.2X11 TCS+ MARUTEX</td> <td>1.000</td> <td>PZ</td> </tr> <tr> <td>VI1930A1</td> <td>VITE 5X20 TRUCIOLARE INOX</td> <td>4.000</td> <td>PZ</td> </tr> <tr> <td>VI1996A0</td> <td>VITE M5x35 TCEI ZN</td> <td>4.000</td> <td>PZ</td> </tr> <tr> <td>VM2268A0</td> <td>TAPPO COPRI CALAMITA PORTA</td> <td>1.000</td> <td>PZ</td> </tr> <tr> <td>VM2305A0</td> <td>NOTTOLINO FISSAGGIO TAPPI PORTE MM</td> <td>4.000</td> <td>PZ</td> </tr> <tr> <td>VM2960A0</td> <td>ASSEMBLATO TAPPO INF SX PORTA S6 LEF</td> <td>1.000</td> <td>PZ</td> </tr> </tbody> </table>	Code	Description	Qty	UOM	VE1030A1	CALAMITA D=22,9mm PER MICROPORTA	1.000	PZ	VI1220A1	VITE AUTOFIL. 4.2X11 TCS+ MARUTEX	1.000	PZ	VI1930A1	VITE 5X20 TRUCIOLARE INOX	4.000	PZ	VI1996A0	VITE M5x35 TCEI ZN	4.000	PZ	VM2268A0	TAPPO COPRI CALAMITA PORTA	1.000	PZ	VM2305A0	NOTTOLINO FISSAGGIO TAPPI PORTE MM	4.000	PZ	VM2960A0	ASSEMBLATO TAPPO INF SX PORTA S6 LEF	1.000	PZ
			Code	Description	Qty	UOM																															
			VE1030A1	CALAMITA D=22,9mm PER MICROPORTA	1.000	PZ																															
VI1220A1	VITE AUTOFIL. 4.2X11 TCS+ MARUTEX	1.000	PZ																																		
VI1930A1	VITE 5X20 TRUCIOLARE INOX	4.000	PZ																																		
VI1996A0	VITE M5x35 TCEI ZN	4.000	PZ																																		
VM2268A0	TAPPO COPRI CALAMITA PORTA	1.000	PZ																																		
VM2305A0	NOTTOLINO FISSAGGIO TAPPI PORTE MM	4.000	PZ																																		
VM2960A0	ASSEMBLATO TAPPO INF SX PORTA S6 LEF	1.000	PZ																																		
KVM2385B	MM -M LEFT DOOR LEFT UPPER CAP KI	<table border="1"> <thead> <tr> <th>Code</th> <th>Description</th> <th>Qty</th> <th>UOM</th> </tr> </thead> <tbody> <tr> <td>VE1030A1</td> <td>CALAMITA D=22,9mm PER MICROPORTA</td> <td>1.000</td> <td>PZ</td> </tr> <tr> <td>VI1220A1</td> <td>VITE AUTOFIL. 4.2X11 TCS+ MARUTEX</td> <td>1.000</td> <td>PZ</td> </tr> <tr> <td>VI1930A1</td> <td>VITE 5X20 TRUCIOLARE INOX</td> <td>4.000</td> <td>PZ</td> </tr> <tr> <td>VI1996A0</td> <td>VITE M5x35 TCEI ZN</td> <td>4.000</td> <td>PZ</td> </tr> <tr> <td>VM2268A0</td> <td>TAPPO COPRI CALAMITA PORTA</td> <td>1.000</td> <td>PZ</td> </tr> <tr> <td>VM2305A0</td> <td>NOTTOLINO FISSAGGIO TAPPI PORTE MM</td> <td>4.000</td> <td>PZ</td> </tr> <tr> <td>VM2959A0</td> <td>ASSEMBLATO TAPPO SUP SX PORTA MM LEFT</td> <td>1.000</td> <td>PZ</td> </tr> </tbody> </table>	Code	Description	Qty	UOM	VE1030A1	CALAMITA D=22,9mm PER MICROPORTA	1.000	PZ	VI1220A1	VITE AUTOFIL. 4.2X11 TCS+ MARUTEX	1.000	PZ	VI1930A1	VITE 5X20 TRUCIOLARE INOX	4.000	PZ	VI1996A0	VITE M5x35 TCEI ZN	4.000	PZ	VM2268A0	TAPPO COPRI CALAMITA PORTA	1.000	PZ	VM2305A0	NOTTOLINO FISSAGGIO TAPPI PORTE MM	4.000	PZ	VM2959A0	ASSEMBLATO TAPPO SUP SX PORTA MM LEFT	1.000	PZ			
Code	Description	Qty	UOM																																		
VE1030A1	CALAMITA D=22,9mm PER MICROPORTA	1.000	PZ																																		
VI1220A1	VITE AUTOFIL. 4.2X11 TCS+ MARUTEX	1.000	PZ																																		
VI1930A1	VITE 5X20 TRUCIOLARE INOX	4.000	PZ																																		
VI1996A0	VITE M5x35 TCEI ZN	4.000	PZ																																		
VM2268A0	TAPPO COPRI CALAMITA PORTA	1.000	PZ																																		
VM2305A0	NOTTOLINO FISSAGGIO TAPPI PORTE MM	4.000	PZ																																		
VM2959A0	ASSEMBLATO TAPPO SUP SX PORTA MM LEFT	1.000	PZ																																		
KVM2269A	INNER GLASS FIXING CAP KIT	<table border="1"> <thead> <tr> <th>Code</th> <th>Description</th> <th>Qty</th> <th>UOM</th> </tr> </thead> <tbody> <tr> <td>VM2267A1</td> <td>CORSOIO SISTEMA FERMA VETRO INT</td> <td>1.000</td> <td>PZ</td> </tr> <tr> <td>VM2269A0</td> <td>TAPPO SISTEMA FERMA VETRO INT</td> <td>2.000</td> <td>PZ</td> </tr> </tbody> </table>	Code	Description	Qty	UOM	VM2267A1	CORSOIO SISTEMA FERMA VETRO INT	1.000	PZ	VM2269A0	TAPPO SISTEMA FERMA VETRO INT	2.000	PZ																							
Code	Description	Qty	UOM																																		
VM2267A1	CORSOIO SISTEMA FERMA VETRO INT	1.000	PZ																																		
VM2269A0	TAPPO SISTEMA FERMA VETRO INT	2.000	PZ																																		

COMPONENT			SPARE PART																																		
Code	Description	Image	Code	Description	Kit components																																
VM2267A	CORSOIO SISTEMA FERMA VETRO INT		KVM2262B	MIND.MAPS -M DOOR RIGHT UPPER CAP KIT	<table border="1"> <thead> <tr> <th>Code</th> <th>Description</th> <th>Qty</th> <th>UOM</th> </tr> </thead> <tbody> <tr> <td>VE1030A1</td> <td>CALAMITA D=22,9mm PER MICROPORTA</td> <td>1.000</td> <td>PZ</td> </tr> <tr> <td>VI1220A1</td> <td>VITE AUTOFIL. 4.2X11 TCS+ MARUTEX</td> <td>1.000</td> <td>PZ</td> </tr> <tr> <td>VI1930A1</td> <td>VITE 5X20 TRUCIOLARE INOX</td> <td>4.000</td> <td>PZ</td> </tr> <tr> <td>VI1996A0</td> <td>VITE M5x35 TCEI ZN</td> <td>4.000</td> <td>PZ</td> </tr> <tr> <td>VM2268A0</td> <td>TAPPO COPRI CALAMITA PORTA</td> <td>1.000</td> <td>PZ</td> </tr> <tr> <td>VM2305A0</td> <td>NOTTOLINO FISSAGGIO TAPPI PORTE MM</td> <td>4.000</td> <td>PZ</td> </tr> <tr> <td>VM2956A0</td> <td>ASSEMBLATO TAPPO SUP DX PORTA MM -M</td> <td>1.000</td> <td>PZ</td> </tr> </tbody> </table>	Code	Description	Qty	UOM	VE1030A1	CALAMITA D=22,9mm PER MICROPORTA	1.000	PZ	VI1220A1	VITE AUTOFIL. 4.2X11 TCS+ MARUTEX	1.000	PZ	VI1930A1	VITE 5X20 TRUCIOLARE INOX	4.000	PZ	VI1996A0	VITE M5x35 TCEI ZN	4.000	PZ	VM2268A0	TAPPO COPRI CALAMITA PORTA	1.000	PZ	VM2305A0	NOTTOLINO FISSAGGIO TAPPI PORTE MM	4.000	PZ	VM2956A0	ASSEMBLATO TAPPO SUP DX PORTA MM -M	1.000	PZ
			Code	Description	Qty	UOM																															
			VE1030A1	CALAMITA D=22,9mm PER MICROPORTA	1.000	PZ																															
VI1220A1	VITE AUTOFIL. 4.2X11 TCS+ MARUTEX	1.000	PZ																																		
VI1930A1	VITE 5X20 TRUCIOLARE INOX	4.000	PZ																																		
VI1996A0	VITE M5x35 TCEI ZN	4.000	PZ																																		
VM2268A0	TAPPO COPRI CALAMITA PORTA	1.000	PZ																																		
VM2305A0	NOTTOLINO FISSAGGIO TAPPI PORTE MM	4.000	PZ																																		
VM2956A0	ASSEMBLATO TAPPO SUP DX PORTA MM -M	1.000	PZ																																		
KVM2261B	MIND.MAPS -M DOOR RIGHT LOWER CAP KIT	<table border="1"> <thead> <tr> <th>Code</th> <th>Description</th> <th>Qty</th> <th>UOM</th> </tr> </thead> <tbody> <tr> <td>VE1030A1</td> <td>CALAMITA D=22,9mm PER MICROPORTA</td> <td>1.000</td> <td>PZ</td> </tr> <tr> <td>VI1220A1</td> <td>VITE AUTOFIL. 4.2X11 TCS+ MARUTEX</td> <td>1.000</td> <td>PZ</td> </tr> <tr> <td>VI1930A1</td> <td>VITE 5X20 TRUCIOLARE INOX</td> <td>4.000</td> <td>PZ</td> </tr> <tr> <td>VI1996A0</td> <td>VITE M5x35 TCEI ZN</td> <td>4.000</td> <td>PZ</td> </tr> <tr> <td>VM2268A0</td> <td>TAPPO COPRI CALAMITA PORTA</td> <td>1.000</td> <td>PZ</td> </tr> <tr> <td>VM2305A0</td> <td>NOTTOLINO FISSAGGIO TAPPI PORTE MM</td> <td>4.000</td> <td>PZ</td> </tr> <tr> <td>VM2957A0</td> <td>ASSEMBLATO TAPPO INF DX PORTA MM -M</td> <td>1.000</td> <td>PZ</td> </tr> </tbody> </table>	Code	Description	Qty	UOM	VE1030A1	CALAMITA D=22,9mm PER MICROPORTA	1.000	PZ	VI1220A1	VITE AUTOFIL. 4.2X11 TCS+ MARUTEX	1.000	PZ	VI1930A1	VITE 5X20 TRUCIOLARE INOX	4.000	PZ	VI1996A0	VITE M5x35 TCEI ZN	4.000	PZ	VM2268A0	TAPPO COPRI CALAMITA PORTA	1.000	PZ	VM2305A0	NOTTOLINO FISSAGGIO TAPPI PORTE MM	4.000	PZ	VM2957A0	ASSEMBLATO TAPPO INF DX PORTA MM -M	1.000	PZ			
Code	Description	Qty	UOM																																		
VE1030A1	CALAMITA D=22,9mm PER MICROPORTA	1.000	PZ																																		
VI1220A1	VITE AUTOFIL. 4.2X11 TCS+ MARUTEX	1.000	PZ																																		
VI1930A1	VITE 5X20 TRUCIOLARE INOX	4.000	PZ																																		
VI1996A0	VITE M5x35 TCEI ZN	4.000	PZ																																		
VM2268A0	TAPPO COPRI CALAMITA PORTA	1.000	PZ																																		
VM2305A0	NOTTOLINO FISSAGGIO TAPPI PORTE MM	4.000	PZ																																		
VM2957A0	ASSEMBLATO TAPPO INF DX PORTA MM -M	1.000	PZ																																		
K0B1155AR	XECC RIGHT DOOR LOWER BEAM KIT	<table border="1"> <thead> <tr> <th>Code</th> <th>Description</th> <th>Qty</th> <th>UOM</th> </tr> </thead> <tbody> <tr> <td>0B1155A1</td> <td>TRAVERSO INFERIORE PORTA XECC RIGHT</td> <td>1.000</td> <td>PZ</td> </tr> <tr> <td>RC1200A0</td> <td>MOLLA A COMPRESSIO NE De4 Df0.5 H24</td> <td>2.000</td> <td>PZ</td> </tr> </tbody> </table>	Code	Description	Qty	UOM	0B1155A1	TRAVERSO INFERIORE PORTA XECC RIGHT	1.000	PZ	RC1200A0	MOLLA A COMPRESSIO NE De4 Df0.5 H24	2.000	PZ																							
Code	Description	Qty	UOM																																		
0B1155A1	TRAVERSO INFERIORE PORTA XECC RIGHT	1.000	PZ																																		
RC1200A0	MOLLA A COMPRESSIO NE De4 Df0.5 H24	2.000	PZ																																		

COMPONENT			SPARE PART																																										
Code	Description	Image	Code	Description	Kit components																																								
VM2267A	CORSOIO SISTEMA FERMA VETRO INT		K0B1155AR	XECC RIGHT DOOR LOWER BEAM KIT	<table border="1"> <thead> <tr> <th>Code</th> <th>Description</th> <th>Qty</th> <th>UOM</th> </tr> </thead> <tbody> <tr> <td>VI1220A1</td> <td>VITE AUTOFIL. 4.2X11 TCS+ MARUTEX</td> <td>1.000</td> <td>PZ</td> </tr> <tr> <td>VI1996A0</td> <td>VITE M5x35 TCEI ZN</td> <td>7.000</td> <td>PZ</td> </tr> <tr> <td>VM1794A0</td> <td>FASCETTA 430X4.8 PA66 NERA</td> <td>2.000</td> <td>PZ</td> </tr> <tr> <td>VM2261A1</td> <td>TAPPO INF DX PORTA MM</td> <td>1.000</td> <td>PZ</td> </tr> <tr> <td>VM2267A1</td> <td>CORSOIO SISTEMA FERMA VETRO INT</td> <td>1.000</td> <td>PZ</td> </tr> <tr> <td>VM2269A0</td> <td>TAPPO SISTEMA FERMA VETRO INT</td> <td>1.000</td> <td>PZ</td> </tr> <tr> <td>VM2274A0</td> <td>BOCCOLA SCANALATA CORTA</td> <td>1.000</td> <td>PZ</td> </tr> <tr> <td>VM2305A0</td> <td>NOTTOLINO FISSAGGIO TAPPI PORTE MM</td> <td>7.000</td> <td>PZ</td> </tr> <tr> <td>VM2324A0</td> <td>TAPPO INF SX PORTA XECC</td> <td>1.000</td> <td>PZ</td> </tr> </tbody> </table>	Code	Description	Qty	UOM	VI1220A1	VITE AUTOFIL. 4.2X11 TCS+ MARUTEX	1.000	PZ	VI1996A0	VITE M5x35 TCEI ZN	7.000	PZ	VM1794A0	FASCETTA 430X4.8 PA66 NERA	2.000	PZ	VM2261A1	TAPPO INF DX PORTA MM	1.000	PZ	VM2267A1	CORSOIO SISTEMA FERMA VETRO INT	1.000	PZ	VM2269A0	TAPPO SISTEMA FERMA VETRO INT	1.000	PZ	VM2274A0	BOCCOLA SCANALATA CORTA	1.000	PZ	VM2305A0	NOTTOLINO FISSAGGIO TAPPI PORTE MM	7.000	PZ	VM2324A0	TAPPO INF SX PORTA XECC	1.000	PZ
			Code	Description	Qty	UOM																																							
VI1220A1	VITE AUTOFIL. 4.2X11 TCS+ MARUTEX	1.000	PZ																																										
VI1996A0	VITE M5x35 TCEI ZN	7.000	PZ																																										
VM1794A0	FASCETTA 430X4.8 PA66 NERA	2.000	PZ																																										
VM2261A1	TAPPO INF DX PORTA MM	1.000	PZ																																										
VM2267A1	CORSOIO SISTEMA FERMA VETRO INT	1.000	PZ																																										
VM2269A0	TAPPO SISTEMA FERMA VETRO INT	1.000	PZ																																										
VM2274A0	BOCCOLA SCANALATA CORTA	1.000	PZ																																										
VM2305A0	NOTTOLINO FISSAGGIO TAPPI PORTE MM	7.000	PZ																																										
VM2324A0	TAPPO INF SX PORTA XECC	1.000	PZ																																										
K0B1155AL	XECC LEFT DOOR LOWER BEAM KIT	<table border="1"> <thead> <tr> <th>Code</th> <th>Description</th> <th>Qty</th> <th>UOM</th> </tr> </thead> <tbody> <tr> <td>0B1155A1</td> <td>TRAVERSO INFERIORE PORTA XECC RIGHT</td> <td>1.000</td> <td>PZ</td> </tr> <tr> <td>RC1200A0</td> <td>MOLLA A COMPRESSIO NE D=4 D10.5 H24</td> <td>2.000</td> <td>PZ</td> </tr> <tr> <td>VI1220A1</td> <td>VITE AUTOFIL. 4.2X11 TCS+ MARUTEX</td> <td>1.000</td> <td>PZ</td> </tr> <tr> <td>VI1996A0</td> <td>VITE M5x35 TCEI ZN</td> <td>7.000</td> <td>PZ</td> </tr> <tr> <td>VM1794A0</td> <td>FASCETTA 430X4.8 PA66 NERA</td> <td>2.000</td> <td>PZ</td> </tr> <tr> <td>VM2267A1</td> <td>CORSOIO SISTEMA FERMA VETRO INT</td> <td>1.000</td> <td>PZ</td> </tr> <tr> <td>VM2269A0</td> <td>TAPPO SISTEMA FERMA VETRO INT</td> <td>1.000</td> <td>PZ</td> </tr> </tbody> </table>	Code	Description	Qty	UOM	0B1155A1	TRAVERSO INFERIORE PORTA XECC RIGHT	1.000	PZ	RC1200A0	MOLLA A COMPRESSIO NE D=4 D10.5 H24	2.000	PZ	VI1220A1	VITE AUTOFIL. 4.2X11 TCS+ MARUTEX	1.000	PZ	VI1996A0	VITE M5x35 TCEI ZN	7.000	PZ	VM1794A0	FASCETTA 430X4.8 PA66 NERA	2.000	PZ	VM2267A1	CORSOIO SISTEMA FERMA VETRO INT	1.000	PZ	VM2269A0	TAPPO SISTEMA FERMA VETRO INT	1.000	PZ											
Code	Description	Qty	UOM																																										
0B1155A1	TRAVERSO INFERIORE PORTA XECC RIGHT	1.000	PZ																																										
RC1200A0	MOLLA A COMPRESSIO NE D=4 D10.5 H24	2.000	PZ																																										
VI1220A1	VITE AUTOFIL. 4.2X11 TCS+ MARUTEX	1.000	PZ																																										
VI1996A0	VITE M5x35 TCEI ZN	7.000	PZ																																										
VM1794A0	FASCETTA 430X4.8 PA66 NERA	2.000	PZ																																										
VM2267A1	CORSOIO SISTEMA FERMA VETRO INT	1.000	PZ																																										
VM2269A0	TAPPO SISTEMA FERMA VETRO INT	1.000	PZ																																										

COMPONENT			SPARE PART																																															
Code	Description	Image	Code	Description	Kit components																																													
VM2267A	CORSOIO SISTEMA FERMA VETRO INT		K0B1155AL	XECC LEFT DOOR LOWER BEAM KIT	<table border="1"> <thead> <tr> <th>Code</th> <th>Description</th> <th>Qty</th> <th>UOM</th> </tr> </thead> <tbody> <tr> <td>VM2274A0</td> <td>BOCCOLA SCANALATA CORTA</td> <td>1.000</td> <td>PZ</td> </tr> <tr> <td>VM2305A0</td> <td>NOTTOLINO FISSAGGIO TAPPI PORTE MM</td> <td>7.000</td> <td>PZ</td> </tr> <tr> <td>VM2325A0</td> <td>TAPPO SUP SX PORTA XECC</td> <td>1.000</td> <td>PZ</td> </tr> <tr> <td>VM2386A1</td> <td>TAPPO INF SX PORTA MM LEFT</td> <td>1.000</td> <td>PZ</td> </tr> </tbody> </table>	Code	Description	Qty	UOM	VM2274A0	BOCCOLA SCANALATA CORTA	1.000	PZ	VM2305A0	NOTTOLINO FISSAGGIO TAPPI PORTE MM	7.000	PZ	VM2325A0	TAPPO SUP SX PORTA XECC	1.000	PZ	VM2386A1	TAPPO INF SX PORTA MM LEFT	1.000	PZ																									
			Code	Description	Qty	UOM																																												
			VM2274A0	BOCCOLA SCANALATA CORTA	1.000	PZ																																												
VM2305A0	NOTTOLINO FISSAGGIO TAPPI PORTE MM	7.000	PZ																																															
VM2325A0	TAPPO SUP SX PORTA XECC	1.000	PZ																																															
VM2386A1	TAPPO INF SX PORTA MM LEFT	1.000	PZ																																															
K0B1126AR	BAKERTOP MM RIGHT DOOR LOWER BEAM KIT	<table border="1"> <thead> <tr> <th>Code</th> <th>Description</th> <th>Qty</th> <th>UOM</th> </tr> </thead> <tbody> <tr> <td>0B1126A1</td> <td>TRAVERSO INFERIORE PORTA 860 M</td> <td>1.000</td> <td>PZ</td> </tr> <tr> <td>RC1200A0</td> <td>MOLLA A COMPRESSIO NE De4 D10.5 H24</td> <td>2.000</td> <td>PZ</td> </tr> <tr> <td>VI1220A1</td> <td>VITE AUTOFIL. 4.2X11 TCS+ MARUTEX</td> <td>1.000</td> <td>PZ</td> </tr> <tr> <td>VI1996A0</td> <td>VITE M5x35 TCEI ZN</td> <td>7.000</td> <td>PZ</td> </tr> <tr> <td>VM1794A0</td> <td>FASCETTA 430X4.8 PA66 NERA</td> <td>2.000</td> <td>PZ</td> </tr> <tr> <td>VM2259A1</td> <td>TAPPO INF SX PORTA S6</td> <td>1.000</td> <td>PZ</td> </tr> <tr> <td>VM2261A1</td> <td>TAPPO INF DX PORTA MM</td> <td>1.000</td> <td>PZ</td> </tr> <tr> <td>VM2267A1</td> <td>CORSOIO SISTEMA FERMA VETRO INT</td> <td>1.000</td> <td>PZ</td> </tr> <tr> <td>VM2269A0</td> <td>TAPPO SISTEMA FERMA VETRO INT</td> <td>1.000</td> <td>PZ</td> </tr> <tr> <td>VM2274A0</td> <td>BOCCOLA SCANALATA CORTA</td> <td>1.000</td> <td>PZ</td> </tr> <tr> <td>VM2305A0</td> <td>NOTTOLINO FISSAGGIO TAPPI PORTE MM</td> <td>7.000</td> <td>PZ</td> </tr> </tbody> </table>	Code	Description	Qty	UOM	0B1126A1	TRAVERSO INFERIORE PORTA 860 M	1.000	PZ	RC1200A0	MOLLA A COMPRESSIO NE De4 D10.5 H24	2.000	PZ	VI1220A1	VITE AUTOFIL. 4.2X11 TCS+ MARUTEX	1.000	PZ	VI1996A0	VITE M5x35 TCEI ZN	7.000	PZ	VM1794A0	FASCETTA 430X4.8 PA66 NERA	2.000	PZ	VM2259A1	TAPPO INF SX PORTA S6	1.000	PZ	VM2261A1	TAPPO INF DX PORTA MM	1.000	PZ	VM2267A1	CORSOIO SISTEMA FERMA VETRO INT	1.000	PZ	VM2269A0	TAPPO SISTEMA FERMA VETRO INT	1.000	PZ	VM2274A0	BOCCOLA SCANALATA CORTA	1.000	PZ	VM2305A0	NOTTOLINO FISSAGGIO TAPPI PORTE MM	7.000	PZ
Code	Description	Qty	UOM																																															
0B1126A1	TRAVERSO INFERIORE PORTA 860 M	1.000	PZ																																															
RC1200A0	MOLLA A COMPRESSIO NE De4 D10.5 H24	2.000	PZ																																															
VI1220A1	VITE AUTOFIL. 4.2X11 TCS+ MARUTEX	1.000	PZ																																															
VI1996A0	VITE M5x35 TCEI ZN	7.000	PZ																																															
VM1794A0	FASCETTA 430X4.8 PA66 NERA	2.000	PZ																																															
VM2259A1	TAPPO INF SX PORTA S6	1.000	PZ																																															
VM2261A1	TAPPO INF DX PORTA MM	1.000	PZ																																															
VM2267A1	CORSOIO SISTEMA FERMA VETRO INT	1.000	PZ																																															
VM2269A0	TAPPO SISTEMA FERMA VETRO INT	1.000	PZ																																															
VM2274A0	BOCCOLA SCANALATA CORTA	1.000	PZ																																															
VM2305A0	NOTTOLINO FISSAGGIO TAPPI PORTE MM	7.000	PZ																																															
K0B1126AL	EU AND 2/1 MM LEFT DOOR LOWER BEAM KIT	<table border="1"> <thead> <tr> <th>Code</th> <th>Description</th> <th>Qty</th> <th>UOM</th> </tr> </thead> <tbody> <tr> <td>0B1126A1</td> <td>TRAVERSO INFERIORE PORTA 860 M</td> <td>1.000</td> <td>PZ</td> </tr> </tbody> </table>	Code	Description	Qty	UOM	0B1126A1	TRAVERSO INFERIORE PORTA 860 M	1.000	PZ																																								
Code	Description	Qty	UOM																																															
0B1126A1	TRAVERSO INFERIORE PORTA 860 M	1.000	PZ																																															

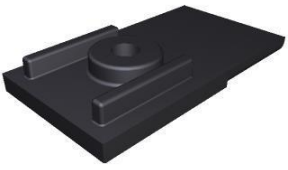

COMPONENT			SPARE PART																																																																																	
Code	Description	Image	Code	Description	Kit components																																																																															
VM2267A	CORSOIO SISTEMA FERMA VETRO INT		K0B1126AL	EU AND 2/1 MM LEFT DOOR LOWER BEAM KIT	<table border="1"> <thead> <tr> <th>Code</th> <th>Description</th> <th>Qty</th> <th>UOM</th> </tr> </thead> <tbody> <tr> <td>RC1200A0</td> <td>MOLLA A COMPRESSIO NE De4 Df0.5 H24</td> <td>2.000</td> <td>PZ</td> </tr> <tr> <td>VI1220A1</td> <td>VITE AUTOFIL. 4.2X11 TCS+ MARUTEX</td> <td>1.000</td> <td>PZ</td> </tr> <tr> <td>VI1996A0</td> <td>VITE M5x35 TCEI ZN</td> <td>7.000</td> <td>PZ</td> </tr> <tr> <td>VM1794A0</td> <td>FASCETTA 430X4.8 PA66 NERA</td> <td>2.000</td> <td>PZ</td> </tr> <tr> <td>VM2267A1</td> <td>CORSOIO SISTEMA FERMA VETRO INT</td> <td>1.000</td> <td>PZ</td> </tr> <tr> <td>VM2269A0</td> <td>TAPPO SISTEMA FERMA VETRO INT</td> <td>1.000</td> <td>PZ</td> </tr> <tr> <td>VM2274A0</td> <td>BOCCOLA SCANALATA CORTA</td> <td>1.000</td> <td>PZ</td> </tr> <tr> <td>VM2305A0</td> <td>NOTTOLINO FISSAGGIO TAPPI PORTE MM</td> <td>7.000</td> <td>PZ</td> </tr> <tr> <td>VM2384A0</td> <td>TAPPO INF DX PORTA MM LEFT</td> <td>1.000</td> <td>PZ</td> </tr> <tr> <td>VM2386A1</td> <td>TAPPO INF SX PORTA MM LEFT</td> <td>1.000</td> <td>PZ</td> </tr> </tbody> </table>	Code	Description	Qty	UOM	RC1200A0	MOLLA A COMPRESSIO NE De4 Df0.5 H24	2.000	PZ	VI1220A1	VITE AUTOFIL. 4.2X11 TCS+ MARUTEX	1.000	PZ	VI1996A0	VITE M5x35 TCEI ZN	7.000	PZ	VM1794A0	FASCETTA 430X4.8 PA66 NERA	2.000	PZ	VM2267A1	CORSOIO SISTEMA FERMA VETRO INT	1.000	PZ	VM2269A0	TAPPO SISTEMA FERMA VETRO INT	1.000	PZ	VM2274A0	BOCCOLA SCANALATA CORTA	1.000	PZ	VM2305A0	NOTTOLINO FISSAGGIO TAPPI PORTE MM	7.000	PZ	VM2384A0	TAPPO INF DX PORTA MM LEFT	1.000	PZ	VM2386A1	TAPPO INF SX PORTA MM LEFT	1.000	PZ	K0B1122AR	CHEFTOP MM RIGHT DOOR LOWER BEAM KIT	<table border="1"> <thead> <tr> <th>Code</th> <th>Description</th> <th>Qty</th> <th>UOM</th> </tr> </thead> <tbody> <tr> <td>OB1122A1</td> <td>TRAVERSO INFERIORE PORTA 750 S6</td> <td>1.000</td> <td>PZ</td> </tr> <tr> <td>RC1200A0</td> <td>MOLLA A COMPRESSIO NE De4 Df0.5 H24</td> <td>2.000</td> <td>PZ</td> </tr> <tr> <td>VI1220A1</td> <td>VITE AUTOFIL. 4.2X11 TCS+ MARUTEX</td> <td>1.000</td> <td>PZ</td> </tr> <tr> <td>VI1996A0</td> <td>VITE M5x35 TCEI ZN</td> <td>7.000</td> <td>PZ</td> </tr> <tr> <td>VM2259A1</td> <td>TAPPO INF SX PORTA S6</td> <td>1.000</td> <td>PZ</td> </tr> <tr> <td>VM2261A1</td> <td>TAPPO INF DX PORTA MM</td> <td>1.000</td> <td>PZ</td> </tr> <tr> <td>VM2267A1</td> <td>CORSOIO SISTEMA FERMA VETRO INT</td> <td>1.000</td> <td>PZ</td> </tr> </tbody> </table>	Code	Description	Qty	UOM	OB1122A1	TRAVERSO INFERIORE PORTA 750 S6	1.000	PZ	RC1200A0	MOLLA A COMPRESSIO NE De4 Df0.5 H24	2.000	PZ	VI1220A1	VITE AUTOFIL. 4.2X11 TCS+ MARUTEX	1.000	PZ	VI1996A0	VITE M5x35 TCEI ZN	7.000	PZ	VM2259A1	TAPPO INF SX PORTA S6	1.000	PZ	VM2261A1	TAPPO INF DX PORTA MM	1.000	PZ	VM2267A1	CORSOIO SISTEMA FERMA VETRO INT	1.000	PZ
			Code	Description	Qty	UOM																																																																														
RC1200A0	MOLLA A COMPRESSIO NE De4 Df0.5 H24	2.000	PZ																																																																																	
VI1220A1	VITE AUTOFIL. 4.2X11 TCS+ MARUTEX	1.000	PZ																																																																																	
VI1996A0	VITE M5x35 TCEI ZN	7.000	PZ																																																																																	
VM1794A0	FASCETTA 430X4.8 PA66 NERA	2.000	PZ																																																																																	
VM2267A1	CORSOIO SISTEMA FERMA VETRO INT	1.000	PZ																																																																																	
VM2269A0	TAPPO SISTEMA FERMA VETRO INT	1.000	PZ																																																																																	
VM2274A0	BOCCOLA SCANALATA CORTA	1.000	PZ																																																																																	
VM2305A0	NOTTOLINO FISSAGGIO TAPPI PORTE MM	7.000	PZ																																																																																	
VM2384A0	TAPPO INF DX PORTA MM LEFT	1.000	PZ																																																																																	
VM2386A1	TAPPO INF SX PORTA MM LEFT	1.000	PZ																																																																																	
Code	Description	Qty	UOM																																																																																	
OB1122A1	TRAVERSO INFERIORE PORTA 750 S6	1.000	PZ																																																																																	
RC1200A0	MOLLA A COMPRESSIO NE De4 Df0.5 H24	2.000	PZ																																																																																	
VI1220A1	VITE AUTOFIL. 4.2X11 TCS+ MARUTEX	1.000	PZ																																																																																	
VI1996A0	VITE M5x35 TCEI ZN	7.000	PZ																																																																																	
VM2259A1	TAPPO INF SX PORTA S6	1.000	PZ																																																																																	
VM2261A1	TAPPO INF DX PORTA MM	1.000	PZ																																																																																	
VM2267A1	CORSOIO SISTEMA FERMA VETRO INT	1.000	PZ																																																																																	

COMPONENT			SPARE PART																																															
Code	Description	Image	Code	Description	Kit components																																													
VM2267A	CORSOIO SISTEMA FERMA VETRO INT		K0B1122AR	CHEFTOP MM RIGHT DOOR LOWER BEAM KIT	<table border="1"> <thead> <tr> <th>Code</th> <th>Description</th> <th>Qty</th> <th>UOM</th> </tr> </thead> <tbody> <tr> <td>VM2269A0</td> <td>TAPPO SISTEMA FERMA VETRO INT</td> <td>1.000</td> <td>PZ</td> </tr> <tr> <td>VM2274A0</td> <td>BOCCOLA SCANALATA CORTA</td> <td>1.000</td> <td>PZ</td> </tr> <tr> <td>VM2305A0</td> <td>NOTTOLINO FISSAGGIO TAPPI PORTE MM</td> <td>7.000</td> <td>PZ</td> </tr> </tbody> </table>	Code	Description	Qty	UOM	VM2269A0	TAPPO SISTEMA FERMA VETRO INT	1.000	PZ	VM2274A0	BOCCOLA SCANALATA CORTA	1.000	PZ	VM2305A0	NOTTOLINO FISSAGGIO TAPPI PORTE MM	7.000	PZ																													
			Code	Description	Qty	UOM																																												
VM2269A0	TAPPO SISTEMA FERMA VETRO INT	1.000	PZ																																															
VM2274A0	BOCCOLA SCANALATA CORTA	1.000	PZ																																															
VM2305A0	NOTTOLINO FISSAGGIO TAPPI PORTE MM	7.000	PZ																																															
K0B1122AL	CHEFTOP MM LEFT DOOR LOWER BEAM KIT	<table border="1"> <thead> <tr> <th>Code</th> <th>Description</th> <th>Qty</th> <th>UOM</th> </tr> </thead> <tbody> <tr> <td>0B1122A1</td> <td>TRAVERSO INFERIORE PORTA 750 S6</td> <td>1.000</td> <td>PZ</td> </tr> <tr> <td>RC1200A0</td> <td>MOLLA A COMPRESSIO NE De4 Df0.5 H24</td> <td>2.000</td> <td>PZ</td> </tr> <tr> <td>V11220A1</td> <td>VITE AUTOFIL. 4.2X11 TCS+ MARUTEX</td> <td>1.000</td> <td>PZ</td> </tr> <tr> <td>V11996A0</td> <td>VITE M5x35 TCEI ZN</td> <td>7.000</td> <td>PZ</td> </tr> <tr> <td>VM1794A0</td> <td>FASCETTA 430X4.8 PA66 NERA</td> <td>2.000</td> <td>PZ</td> </tr> <tr> <td>VM2267A1</td> <td>CORSOIO SISTEMA FERMA VETRO INT</td> <td>1.000</td> <td>PZ</td> </tr> <tr> <td>VM2269A0</td> <td>TAPPO SISTEMA FERMA VETRO INT</td> <td>1.000</td> <td>PZ</td> </tr> <tr> <td>VM2274A0</td> <td>BOCCOLA SCANALATA CORTA</td> <td>1.000</td> <td>PZ</td> </tr> <tr> <td>VM2305A0</td> <td>NOTTOLINO FISSAGGIO TAPPI PORTE MM</td> <td>7.000</td> <td>PZ</td> </tr> <tr> <td>VM2384A0</td> <td>TAPPO INF DX PORTA MM LEFT</td> <td>1.000</td> <td>PZ</td> </tr> <tr> <td>VM2386A1</td> <td>TAPPO INF SX PORTA MM LEFT</td> <td>1.000</td> <td>PZ</td> </tr> </tbody> </table>	Code	Description	Qty	UOM	0B1122A1	TRAVERSO INFERIORE PORTA 750 S6	1.000	PZ	RC1200A0	MOLLA A COMPRESSIO NE De4 Df0.5 H24	2.000	PZ	V11220A1	VITE AUTOFIL. 4.2X11 TCS+ MARUTEX	1.000	PZ	V11996A0	VITE M5x35 TCEI ZN	7.000	PZ	VM1794A0	FASCETTA 430X4.8 PA66 NERA	2.000	PZ	VM2267A1	CORSOIO SISTEMA FERMA VETRO INT	1.000	PZ	VM2269A0	TAPPO SISTEMA FERMA VETRO INT	1.000	PZ	VM2274A0	BOCCOLA SCANALATA CORTA	1.000	PZ	VM2305A0	NOTTOLINO FISSAGGIO TAPPI PORTE MM	7.000	PZ	VM2384A0	TAPPO INF DX PORTA MM LEFT	1.000	PZ	VM2386A1	TAPPO INF SX PORTA MM LEFT	1.000	PZ
Code	Description	Qty	UOM																																															
0B1122A1	TRAVERSO INFERIORE PORTA 750 S6	1.000	PZ																																															
RC1200A0	MOLLA A COMPRESSIO NE De4 Df0.5 H24	2.000	PZ																																															
V11220A1	VITE AUTOFIL. 4.2X11 TCS+ MARUTEX	1.000	PZ																																															
V11996A0	VITE M5x35 TCEI ZN	7.000	PZ																																															
VM1794A0	FASCETTA 430X4.8 PA66 NERA	2.000	PZ																																															
VM2267A1	CORSOIO SISTEMA FERMA VETRO INT	1.000	PZ																																															
VM2269A0	TAPPO SISTEMA FERMA VETRO INT	1.000	PZ																																															
VM2274A0	BOCCOLA SCANALATA CORTA	1.000	PZ																																															
VM2305A0	NOTTOLINO FISSAGGIO TAPPI PORTE MM	7.000	PZ																																															
VM2384A0	TAPPO INF DX PORTA MM LEFT	1.000	PZ																																															
VM2386A1	TAPPO INF SX PORTA MM LEFT	1.000	PZ																																															

COMPONENT			SPARE PART																																		
Code	Description	Image	Code	Description	Kit components																																
VM2269B	VM2269B1		OUTOFPRODUCTIO	ITEM OUT OF PRODUCTION																																	
			KVM2386B	MM -M LEFT DOOR LEFT LOWER CAP KI	<table border="1"> <thead> <tr> <th>Code</th> <th>Description</th> <th>Qty</th> <th>UOM</th> </tr> </thead> <tbody> <tr> <td>VE1030A1</td> <td>CALAMITA D=22,9mm PER MICROPORTA</td> <td>1.000</td> <td>PZ</td> </tr> <tr> <td>VI1220A1</td> <td>VITE AUTOFIL. 4.2X11 TCS+ MARUTEX</td> <td>1.000</td> <td>PZ</td> </tr> <tr> <td>VI1930A1</td> <td>VITE 5X20 TRUCIOLARE INOX</td> <td>4.000</td> <td>PZ</td> </tr> <tr> <td>VI1996A0</td> <td>VITE M5x35 TCEI ZN</td> <td>4.000</td> <td>PZ</td> </tr> <tr> <td>VM2268A0</td> <td>TAPPO COPRI CALAMITA PORTA</td> <td>1.000</td> <td>PZ</td> </tr> <tr> <td>VM2305A0</td> <td>NOTTOLINO FISSAGGIO TAPPI PORTE MM</td> <td>4.000</td> <td>PZ</td> </tr> <tr> <td>VM2960A0</td> <td>ASSEMBLATO TAPPO INF SX PORTA S6 LEF</td> <td>1.000</td> <td>PZ</td> </tr> </tbody> </table>	Code	Description	Qty	UOM	VE1030A1	CALAMITA D=22,9mm PER MICROPORTA	1.000	PZ	VI1220A1	VITE AUTOFIL. 4.2X11 TCS+ MARUTEX	1.000	PZ	VI1930A1	VITE 5X20 TRUCIOLARE INOX	4.000	PZ	VI1996A0	VITE M5x35 TCEI ZN	4.000	PZ	VM2268A0	TAPPO COPRI CALAMITA PORTA	1.000	PZ	VM2305A0	NOTTOLINO FISSAGGIO TAPPI PORTE MM	4.000	PZ	VM2960A0	ASSEMBLATO TAPPO INF SX PORTA S6 LEF	1.000	PZ
			Code	Description	Qty	UOM																															
VE1030A1	CALAMITA D=22,9mm PER MICROPORTA	1.000	PZ																																		
VI1220A1	VITE AUTOFIL. 4.2X11 TCS+ MARUTEX	1.000	PZ																																		
VI1930A1	VITE 5X20 TRUCIOLARE INOX	4.000	PZ																																		
VI1996A0	VITE M5x35 TCEI ZN	4.000	PZ																																		
VM2268A0	TAPPO COPRI CALAMITA PORTA	1.000	PZ																																		
VM2305A0	NOTTOLINO FISSAGGIO TAPPI PORTE MM	4.000	PZ																																		
VM2960A0	ASSEMBLATO TAPPO INF SX PORTA S6 LEF	1.000	PZ																																		
KVM2385B	MM -M LEFT DOOR LEFT UPPER CAP KI	<table border="1"> <thead> <tr> <th>Code</th> <th>Description</th> <th>Qty</th> <th>UOM</th> </tr> </thead> <tbody> <tr> <td>VE1030A1</td> <td>CALAMITA D=22,9mm PER MICROPORTA</td> <td>1.000</td> <td>PZ</td> </tr> <tr> <td>VI1220A1</td> <td>VITE AUTOFIL. 4.2X11 TCS+ MARUTEX</td> <td>1.000</td> <td>PZ</td> </tr> <tr> <td>VI1930A1</td> <td>VITE 5X20 TRUCIOLARE INOX</td> <td>4.000</td> <td>PZ</td> </tr> <tr> <td>VI1996A0</td> <td>VITE M5x35 TCEI ZN</td> <td>4.000</td> <td>PZ</td> </tr> <tr> <td>VM2268A0</td> <td>TAPPO COPRI CALAMITA PORTA</td> <td>1.000</td> <td>PZ</td> </tr> <tr> <td>VM2305A0</td> <td>NOTTOLINO FISSAGGIO TAPPI PORTE MM</td> <td>4.000</td> <td>PZ</td> </tr> <tr> <td>VM2959A0</td> <td>ASSEMBLATO TAPPO SUP SX PORTA MM LEFT</td> <td>1.000</td> <td>PZ</td> </tr> </tbody> </table>	Code	Description	Qty	UOM	VE1030A1	CALAMITA D=22,9mm PER MICROPORTA	1.000	PZ	VI1220A1	VITE AUTOFIL. 4.2X11 TCS+ MARUTEX	1.000	PZ	VI1930A1	VITE 5X20 TRUCIOLARE INOX	4.000	PZ	VI1996A0	VITE M5x35 TCEI ZN	4.000	PZ	VM2268A0	TAPPO COPRI CALAMITA PORTA	1.000	PZ	VM2305A0	NOTTOLINO FISSAGGIO TAPPI PORTE MM	4.000	PZ	VM2959A0	ASSEMBLATO TAPPO SUP SX PORTA MM LEFT	1.000	PZ			
Code	Description	Qty	UOM																																		
VE1030A1	CALAMITA D=22,9mm PER MICROPORTA	1.000	PZ																																		
VI1220A1	VITE AUTOFIL. 4.2X11 TCS+ MARUTEX	1.000	PZ																																		
VI1930A1	VITE 5X20 TRUCIOLARE INOX	4.000	PZ																																		
VI1996A0	VITE M5x35 TCEI ZN	4.000	PZ																																		
VM2268A0	TAPPO COPRI CALAMITA PORTA	1.000	PZ																																		
VM2305A0	NOTTOLINO FISSAGGIO TAPPI PORTE MM	4.000	PZ																																		
VM2959A0	ASSEMBLATO TAPPO SUP SX PORTA MM LEFT	1.000	PZ																																		
KVM2261B	MIND.MAPS -M DOOR RIGHT LOWER CAP KIT	<table border="1"> <thead> <tr> <th>Code</th> <th>Description</th> <th>Qty</th> <th>UOM</th> </tr> </thead> <tbody> <tr> <td>VE1030A1</td> <td>CALAMITA D=22,9mm PER MICROPORTA</td> <td>1.000</td> <td>PZ</td> </tr> </tbody> </table>	Code	Description	Qty	UOM	VE1030A1	CALAMITA D=22,9mm PER MICROPORTA	1.000	PZ																											
Code	Description	Qty	UOM																																		
VE1030A1	CALAMITA D=22,9mm PER MICROPORTA	1.000	PZ																																		

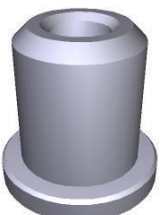
COMPONENT			SPARE PART																																						
Code	Description	Image	Code	Description	Kit components																																				
VM2269B	VM2269B1		KVM2261B	MIND.MAPS -M DOOR RIGHT LOWER CAP KIT	<table border="1"> <thead> <tr> <th>Code</th> <th>Description</th> <th>Qty</th> <th>UOM</th> </tr> </thead> <tbody> <tr> <td>VI1220A1</td> <td>VITE AUTOFIL. 4.2X11 TCS+ MARUTEX</td> <td>1.000</td> <td>PZ</td> </tr> <tr> <td>VI1930A1</td> <td>VITE 5X20 TRUCIOLARE INOX</td> <td>4.000</td> <td>PZ</td> </tr> <tr> <td>VI1996A0</td> <td>VITE M5x35 TCEI ZN</td> <td>4.000</td> <td>PZ</td> </tr> <tr> <td>VM2268A0</td> <td>TAPPO COPRI CALAMITA PORTA</td> <td>1.000</td> <td>PZ</td> </tr> <tr> <td>VM2305A0</td> <td>NOTTOLINO FISSAGGIO TAPPI PORTE MM</td> <td>4.000</td> <td>PZ</td> </tr> <tr> <td>VM2957A0</td> <td>ASSEMBLATO TAPPO INF DX PORTA MM -M</td> <td>1.000</td> <td>PZ</td> </tr> </tbody> </table>	Code	Description	Qty	UOM	VI1220A1	VITE AUTOFIL. 4.2X11 TCS+ MARUTEX	1.000	PZ	VI1930A1	VITE 5X20 TRUCIOLARE INOX	4.000	PZ	VI1996A0	VITE M5x35 TCEI ZN	4.000	PZ	VM2268A0	TAPPO COPRI CALAMITA PORTA	1.000	PZ	VM2305A0	NOTTOLINO FISSAGGIO TAPPI PORTE MM	4.000	PZ	VM2957A0	ASSEMBLATO TAPPO INF DX PORTA MM -M	1.000	PZ								
Code	Description	Qty	UOM																																						
VI1220A1	VITE AUTOFIL. 4.2X11 TCS+ MARUTEX	1.000	PZ																																						
VI1930A1	VITE 5X20 TRUCIOLARE INOX	4.000	PZ																																						
VI1996A0	VITE M5x35 TCEI ZN	4.000	PZ																																						
VM2268A0	TAPPO COPRI CALAMITA PORTA	1.000	PZ																																						
VM2305A0	NOTTOLINO FISSAGGIO TAPPI PORTE MM	4.000	PZ																																						
VM2957A0	ASSEMBLATO TAPPO INF DX PORTA MM -M	1.000	PZ																																						
VE1030A	CALAMITA D=22,9mm PER MICROPORTA		KVE1030A	2 PCS MAGNET KIT FOR DOOR SWITCH	<table border="1"> <thead> <tr> <th>Code</th> <th>Description</th> <th>Qty</th> <th>UOM</th> </tr> </thead> <tbody> <tr> <td>VE1030A1</td> <td>CALAMITA D=22,9mm PER MICROPORTA</td> <td>2.000</td> <td>PZ</td> </tr> <tr> <td>VI1220A1</td> <td>VITE AUTOFIL. 4.2X11 TCS+ MARUTEX</td> <td>1.000</td> <td>PZ</td> </tr> </tbody> </table>	Code	Description	Qty	UOM	VE1030A1	CALAMITA D=22,9mm PER MICROPORTA	2.000	PZ	VI1220A1	VITE AUTOFIL. 4.2X11 TCS+ MARUTEX	1.000	PZ																								
Code	Description	Qty	UOM																																						
VE1030A1	CALAMITA D=22,9mm PER MICROPORTA	2.000	PZ																																						
VI1220A1	VITE AUTOFIL. 4.2X11 TCS+ MARUTEX	1.000	PZ																																						
			KVE1020B	MICROSWITCH KIT	<table border="1"> <thead> <tr> <th>Code</th> <th>Description</th> <th>Qty</th> <th>UOM</th> </tr> </thead> <tbody> <tr> <td>CE1030A0</td> <td>FASTON FEMMINA 6.3X0.8 0,5-1mmq</td> <td>2.000</td> <td>PZ</td> </tr> <tr> <td>CE1660A0</td> <td>COPRI FASTON FEMMINA 6.3X0.8</td> <td>2.000</td> <td>PZ</td> </tr> <tr> <td>CE1730A0</td> <td>CAVO PVC NP 2 X AWG22 STYLE 2095</td> <td>0.150</td> <td>M</td> </tr> <tr> <td>CE1740A0</td> <td>TERMINALE MINIFIT MASCHIO</td> <td>2.000</td> <td>PZ</td> </tr> <tr> <td>CE1745A0</td> <td>CONNETTORE MINIFIT FEMMINA 2 VI</td> <td>1.000</td> <td>PZ</td> </tr> <tr> <td>VE1020B0</td> <td>MICROINT. PORTA MAGNETICO CON MINIFIT 2</td> <td>1.000</td> <td>PZ</td> </tr> <tr> <td>VE1030A1</td> <td>CALAMITA D=22,9mm PER MICROPORTA</td> <td>1.000</td> <td>PZ</td> </tr> <tr> <td>VI1192A0</td> <td>DADO M10X0,75 H3 OTTONE NICHELATO</td> <td>1.000</td> <td>PZ</td> </tr> </tbody> </table>	Code	Description	Qty	UOM	CE1030A0	FASTON FEMMINA 6.3X0.8 0,5-1mmq	2.000	PZ	CE1660A0	COPRI FASTON FEMMINA 6.3X0.8	2.000	PZ	CE1730A0	CAVO PVC NP 2 X AWG22 STYLE 2095	0.150	M	CE1740A0	TERMINALE MINIFIT MASCHIO	2.000	PZ	CE1745A0	CONNETTORE MINIFIT FEMMINA 2 VI	1.000	PZ	VE1020B0	MICROINT. PORTA MAGNETICO CON MINIFIT 2	1.000	PZ	VE1030A1	CALAMITA D=22,9mm PER MICROPORTA	1.000	PZ	VI1192A0	DADO M10X0,75 H3 OTTONE NICHELATO	1.000	PZ
Code	Description	Qty	UOM																																						
CE1030A0	FASTON FEMMINA 6.3X0.8 0,5-1mmq	2.000	PZ																																						
CE1660A0	COPRI FASTON FEMMINA 6.3X0.8	2.000	PZ																																						
CE1730A0	CAVO PVC NP 2 X AWG22 STYLE 2095	0.150	M																																						
CE1740A0	TERMINALE MINIFIT MASCHIO	2.000	PZ																																						
CE1745A0	CONNETTORE MINIFIT FEMMINA 2 VI	1.000	PZ																																						
VE1020B0	MICROINT. PORTA MAGNETICO CON MINIFIT 2	1.000	PZ																																						
VE1030A1	CALAMITA D=22,9mm PER MICROPORTA	1.000	PZ																																						
VI1192A0	DADO M10X0,75 H3 OTTONE NICHELATO	1.000	PZ																																						

COMPONENT			SPARE PART																										
Code	Description	Image	Code	Description	Kit components																								
VI1174A	VITE 5X20 PER PLASTICA ZN-NI		VI1174A0	VITE 5X20 PER PLASTICA ZN-NI																									
VI1996A	VITE M5x35 TCEI ZN		VI1996A0	VITE M5x35 TCEI ZN																									
VM2268A	TAPPO COPRI CALAMITA PORTA		KVM2268A	DOOR MAGNET COVER KIT	<table border="1"> <thead> <tr> <th>Code</th> <th>Description</th> <th>Qty</th> <th>UOM</th> </tr> </thead> <tbody> <tr> <td>VM2268A0</td> <td>TAPPO COPRI CALAMITA PORTA</td> <td>1.000</td> <td>PZ</td> </tr> </tbody> </table>	Code	Description	Qty	UOM	VM2268A0	TAPPO COPRI CALAMITA PORTA	1.000	PZ																
Code	Description	Qty	UOM																										
VM2268A0	TAPPO COPRI CALAMITA PORTA	1.000	PZ																										
VM2305A	NOTTOLINO FISSAGGIO TAPPI PORTE MM		KVM2305A	MM FIXING DOOR THUB SCREWS 10 PCS KIT	<table border="1"> <thead> <tr> <th>Code</th> <th>Description</th> <th>Qty</th> <th>UOM</th> </tr> </thead> <tbody> <tr> <td>VM2305A0</td> <td>NOTTOLINO FISSAGGIO TAPPI PORTE MM</td> <td>10.000</td> <td>PZ</td> </tr> </tbody> </table>	Code	Description	Qty	UOM	VM2305A0	NOTTOLINO FISSAGGIO TAPPI PORTE MM	10.000	PZ																
Code	Description	Qty	UOM																										
VM2305A0	NOTTOLINO FISSAGGIO TAPPI PORTE MM	10.000	PZ																										
VM2957A	ASSEMBLATO TAPPO INF DX PORTA MM -M		KVM2261B	MIND.MAPS -M DOOR RIGHT LOWER CAP KIT	<table border="1"> <thead> <tr> <th>Code</th> <th>Description</th> <th>Qty</th> <th>UOM</th> </tr> </thead> <tbody> <tr> <td>VE1030A1</td> <td>CALAMITA D=22,9mm PER MICROPORTA</td> <td>1.000</td> <td>PZ</td> </tr> <tr> <td>VI1220A1</td> <td>VITE AUTOFIL. 4.2X11 TCS+ MARUTEX</td> <td>1.000</td> <td>PZ</td> </tr> <tr> <td>VI1930A1</td> <td>VITE 5X20 TRUCIOLARE INOX</td> <td>4.000</td> <td>PZ</td> </tr> <tr> <td>VI1996A0</td> <td>VITE M5x35 TCEI ZN</td> <td>4.000</td> <td>PZ</td> </tr> <tr> <td>VM2268A0</td> <td>TAPPO COPRI CALAMITA PORTA</td> <td>1.000</td> <td>PZ</td> </tr> </tbody> </table>	Code	Description	Qty	UOM	VE1030A1	CALAMITA D=22,9mm PER MICROPORTA	1.000	PZ	VI1220A1	VITE AUTOFIL. 4.2X11 TCS+ MARUTEX	1.000	PZ	VI1930A1	VITE 5X20 TRUCIOLARE INOX	4.000	PZ	VI1996A0	VITE M5x35 TCEI ZN	4.000	PZ	VM2268A0	TAPPO COPRI CALAMITA PORTA	1.000	PZ
Code	Description	Qty	UOM																										
VE1030A1	CALAMITA D=22,9mm PER MICROPORTA	1.000	PZ																										
VI1220A1	VITE AUTOFIL. 4.2X11 TCS+ MARUTEX	1.000	PZ																										
VI1930A1	VITE 5X20 TRUCIOLARE INOX	4.000	PZ																										
VI1996A0	VITE M5x35 TCEI ZN	4.000	PZ																										
VM2268A0	TAPPO COPRI CALAMITA PORTA	1.000	PZ																										

COMPONENT			SPARE PART																																		
Code	Description	Image	Code	Description	Kit components																																
VM2957A	ASSEMBLATO TAPPO INF DX PORTA MM -M		KVM2261B	MIND.MAPS -M DOOR RIGHT LOWER CAP KIT	<table border="1"> <thead> <tr> <th>Code</th> <th>Description</th> <th>Qty</th> <th>UOM</th> </tr> </thead> <tbody> <tr> <td>VM2305A0</td> <td>NOTTOLINO FISSAGGIO TAPPI PORTE MM</td> <td>4.000</td> <td>PZ</td> </tr> <tr> <td>VM2957A0</td> <td>ASSEMBLATO TAPPO INF DX PORTA MM -M</td> <td>1.000</td> <td>PZ</td> </tr> </tbody> </table>	Code	Description	Qty	UOM	VM2305A0	NOTTOLINO FISSAGGIO TAPPI PORTE MM	4.000	PZ	VM2957A0	ASSEMBLATO TAPPO INF DX PORTA MM -M	1.000	PZ																				
Code	Description	Qty	UOM																																		
VM2305A0	NOTTOLINO FISSAGGIO TAPPI PORTE MM	4.000	PZ																																		
VM2957A0	ASSEMBLATO TAPPO INF DX PORTA MM -M	1.000	PZ																																		
VM2261B	VM2261B1		OUTOFPRODUCTIO	ITEM OUT OF PRODUCTION																																	
VM2267A	CORSOIO SISTEMA FERMA VETRO INT		KVM2386B	MM -M LEFT DOOR LEFT LOWER CAP KI	<table border="1"> <thead> <tr> <th>Code</th> <th>Description</th> <th>Qty</th> <th>UOM</th> </tr> </thead> <tbody> <tr> <td>VE1030A1</td> <td>CALAMITA D=22,9mm PER MICROPORTA</td> <td>1.000</td> <td>PZ</td> </tr> <tr> <td>VI1220A1</td> <td>VITE AUTOFIL. 4.2X11 TCS+ MARUTEX</td> <td>1.000</td> <td>PZ</td> </tr> <tr> <td>VI1930A1</td> <td>VITE 5X20 TRUCIOLARE INOX</td> <td>4.000</td> <td>PZ</td> </tr> <tr> <td>VI1996A0</td> <td>VITE M5x35 TCEI ZN</td> <td>4.000</td> <td>PZ</td> </tr> <tr> <td>VM2268A0</td> <td>TAPPO COPRI CALAMITA PORTA</td> <td>1.000</td> <td>PZ</td> </tr> <tr> <td>VM2305A0</td> <td>NOTTOLINO FISSAGGIO TAPPI PORTE MM</td> <td>4.000</td> <td>PZ</td> </tr> <tr> <td>VM2960A0</td> <td>ASSEMBLATO TAPPO INF SX PORTA S6 LEF</td> <td>1.000</td> <td>PZ</td> </tr> </tbody> </table>	Code	Description	Qty	UOM	VE1030A1	CALAMITA D=22,9mm PER MICROPORTA	1.000	PZ	VI1220A1	VITE AUTOFIL. 4.2X11 TCS+ MARUTEX	1.000	PZ	VI1930A1	VITE 5X20 TRUCIOLARE INOX	4.000	PZ	VI1996A0	VITE M5x35 TCEI ZN	4.000	PZ	VM2268A0	TAPPO COPRI CALAMITA PORTA	1.000	PZ	VM2305A0	NOTTOLINO FISSAGGIO TAPPI PORTE MM	4.000	PZ	VM2960A0	ASSEMBLATO TAPPO INF SX PORTA S6 LEF	1.000	PZ
Code	Description	Qty	UOM																																		
VE1030A1	CALAMITA D=22,9mm PER MICROPORTA	1.000	PZ																																		
VI1220A1	VITE AUTOFIL. 4.2X11 TCS+ MARUTEX	1.000	PZ																																		
VI1930A1	VITE 5X20 TRUCIOLARE INOX	4.000	PZ																																		
VI1996A0	VITE M5x35 TCEI ZN	4.000	PZ																																		
VM2268A0	TAPPO COPRI CALAMITA PORTA	1.000	PZ																																		
VM2305A0	NOTTOLINO FISSAGGIO TAPPI PORTE MM	4.000	PZ																																		
VM2960A0	ASSEMBLATO TAPPO INF SX PORTA S6 LEF	1.000	PZ																																		
			KVM2385B	MM -M LEFT DOOR LEFT UPPER CAP KI	<table border="1"> <thead> <tr> <th>Code</th> <th>Description</th> <th>Qty</th> <th>UOM</th> </tr> </thead> <tbody> <tr> <td>VE1030A1</td> <td>CALAMITA D=22,9mm PER MICROPORTA</td> <td>1.000</td> <td>PZ</td> </tr> <tr> <td>VI1220A1</td> <td>VITE AUTOFIL. 4.2X11 TCS+ MARUTEX</td> <td>1.000</td> <td>PZ</td> </tr> <tr> <td>VI1930A1</td> <td>VITE 5X20 TRUCIOLARE INOX</td> <td>4.000</td> <td>PZ</td> </tr> <tr> <td>VI1996A0</td> <td>VITE M5x35 TCEI ZN</td> <td>4.000</td> <td>PZ</td> </tr> </tbody> </table>	Code	Description	Qty	UOM	VE1030A1	CALAMITA D=22,9mm PER MICROPORTA	1.000	PZ	VI1220A1	VITE AUTOFIL. 4.2X11 TCS+ MARUTEX	1.000	PZ	VI1930A1	VITE 5X20 TRUCIOLARE INOX	4.000	PZ	VI1996A0	VITE M5x35 TCEI ZN	4.000	PZ												
Code	Description	Qty	UOM																																		
VE1030A1	CALAMITA D=22,9mm PER MICROPORTA	1.000	PZ																																		
VI1220A1	VITE AUTOFIL. 4.2X11 TCS+ MARUTEX	1.000	PZ																																		
VI1930A1	VITE 5X20 TRUCIOLARE INOX	4.000	PZ																																		
VI1996A0	VITE M5x35 TCEI ZN	4.000	PZ																																		

COMPONENT			SPARE PART																															
Code	Description	Image	Code	Description	Kit components																													
VM2267A	CORSOIO SISTEMA FERMA VETRO INT		KVM2385B	MM -M LEFT DOOR LEFT UPPER CAP KI	<table border="1"> <thead> <tr> <th>Code</th> <th>Description</th> <th>Qty</th> <th>UOM</th> </tr> </thead> <tbody> <tr> <td>VM2268A0</td> <td>TAPPO COPRI CALAMITA PORTA</td> <td>1.000</td> <td>PZ</td> </tr> <tr> <td>VM2305A0</td> <td>NOTTOLINO FISSAGGIO TAPPI PORTE MM</td> <td>4.000</td> <td>PZ</td> </tr> <tr> <td>VM2959A0</td> <td>ASSEMBLATO TAPPO SUP SX PORTA MM LEFT</td> <td>1.000</td> <td>PZ</td> </tr> </tbody> </table>	Code	Description	Qty	UOM	VM2268A0	TAPPO COPRI CALAMITA PORTA	1.000	PZ	VM2305A0	NOTTOLINO FISSAGGIO TAPPI PORTE MM	4.000	PZ	VM2959A0	ASSEMBLATO TAPPO SUP SX PORTA MM LEFT	1.000	PZ													
			Code	Description	Qty	UOM																												
			VM2268A0	TAPPO COPRI CALAMITA PORTA	1.000	PZ																												
			VM2305A0	NOTTOLINO FISSAGGIO TAPPI PORTE MM	4.000	PZ																												
			VM2959A0	ASSEMBLATO TAPPO SUP SX PORTA MM LEFT	1.000	PZ																												
			KVM2269A	INNER GLASS FIXING CAP KIT	<table border="1"> <thead> <tr> <th>Code</th> <th>Description</th> <th>Qty</th> <th>UOM</th> </tr> </thead> <tbody> <tr> <td>VM2267A1</td> <td>CORSOIO SISTEMA FERMA VETRO INT</td> <td>1.000</td> <td>PZ</td> </tr> <tr> <td>VM2269A0</td> <td>TAPPO SISTEMA FERMA VETRO INT</td> <td>2.000</td> <td>PZ</td> </tr> </tbody> </table>	Code	Description	Qty	UOM	VM2267A1	CORSOIO SISTEMA FERMA VETRO INT	1.000	PZ	VM2269A0	TAPPO SISTEMA FERMA VETRO INT	2.000	PZ																	
			Code	Description	Qty	UOM																												
			VM2267A1	CORSOIO SISTEMA FERMA VETRO INT	1.000	PZ																												
			VM2269A0	TAPPO SISTEMA FERMA VETRO INT	2.000	PZ																												
			KVM2262B	MIND.MAPS -M DOOR RIGHT UPPER CAP KIT	<table border="1"> <thead> <tr> <th>Code</th> <th>Description</th> <th>Qty</th> <th>UOM</th> </tr> </thead> <tbody> <tr> <td>VE1030A1</td> <td>CALAMITA D=22,9mm PER MICROPORTA</td> <td>1.000</td> <td>PZ</td> </tr> <tr> <td>VH1220A1</td> <td>VITE AUTOFIL. 4.2X11 TCS+ MARUTEX</td> <td>1.000</td> <td>PZ</td> </tr> <tr> <td>VI1930A1</td> <td>VITE 5X20 TRUCIOLARE INOX</td> <td>4.000</td> <td>PZ</td> </tr> <tr> <td>VI1996A0</td> <td>VITE M5x35 TCEI ZN</td> <td>4.000</td> <td>PZ</td> </tr> <tr> <td>VM2268A0</td> <td>TAPPO COPRI CALAMITA PORTA</td> <td>1.000</td> <td>PZ</td> </tr> <tr> <td>VM2305A0</td> <td>NOTTOLINO FISSAGGIO TAPPI PORTE MM</td> <td>4.000</td> <td>PZ</td> </tr> <tr> <td>VM2956A0</td> <td>ASSEMBLATO TAPPO SUP DX PORTA MM -M</td> <td>1.000</td> <td>PZ</td> </tr> </tbody> </table>	Code	Description	Qty	UOM	VE1030A1	CALAMITA D=22,9mm PER MICROPORTA	1.000	PZ	VH1220A1	VITE AUTOFIL. 4.2X11 TCS+ MARUTEX	1.000	PZ	VI1930A1	VITE 5X20 TRUCIOLARE INOX	4.000	PZ	VI1996A0	VITE M5x35 TCEI ZN	4.000	PZ	VM2268A0	TAPPO COPRI CALAMITA PORTA	1.000	PZ	VM2305A0	NOTTOLINO FISSAGGIO TAPPI PORTE MM	4.000	PZ	VM2956A0
Code	Description	Qty	UOM																															
VE1030A1	CALAMITA D=22,9mm PER MICROPORTA	1.000	PZ																															
VH1220A1	VITE AUTOFIL. 4.2X11 TCS+ MARUTEX	1.000	PZ																															
VI1930A1	VITE 5X20 TRUCIOLARE INOX	4.000	PZ																															
VI1996A0	VITE M5x35 TCEI ZN	4.000	PZ																															
VM2268A0	TAPPO COPRI CALAMITA PORTA	1.000	PZ																															
VM2305A0	NOTTOLINO FISSAGGIO TAPPI PORTE MM	4.000	PZ																															
VM2956A0	ASSEMBLATO TAPPO SUP DX PORTA MM -M	1.000	PZ																															
KVM2261B	MIND.MAPS -M DOOR RIGHT LOWER CAP KIT	<table border="1"> <thead> <tr> <th>Code</th> <th>Description</th> <th>Qty</th> <th>UOM</th> </tr> </thead> <tbody> <tr> <td>VE1030A1</td> <td>CALAMITA D=22,9mm PER MICROPORTA</td> <td>1.000</td> <td>PZ</td> </tr> <tr> <td>VH1220A1</td> <td>VITE AUTOFIL. 4.2X11 TCS+ MARUTEX</td> <td>1.000</td> <td>PZ</td> </tr> </tbody> </table>	Code	Description	Qty	UOM	VE1030A1	CALAMITA D=22,9mm PER MICROPORTA	1.000	PZ	VH1220A1	VITE AUTOFIL. 4.2X11 TCS+ MARUTEX	1.000	PZ																				
Code	Description	Qty	UOM																															
VE1030A1	CALAMITA D=22,9mm PER MICROPORTA	1.000	PZ																															
VH1220A1	VITE AUTOFIL. 4.2X11 TCS+ MARUTEX	1.000	PZ																															

COMPONENT			SPARE PART																																															
Code	Description	Image	Code	Description	Kit components																																													
VM2267A	CORSOIO SISTEMA FERMA VETRO INT		KVM2261B	MIND.MAPS -M DOOR RIGHT LOWER CAP KIT	<table border="1"> <thead> <tr> <th>Code</th> <th>Description</th> <th>Qty</th> <th>UOM</th> </tr> </thead> <tbody> <tr> <td>VI1930A1</td> <td>VITE 5X20 TRUCIOLARE INOX</td> <td>4.000</td> <td>PZ</td> </tr> <tr> <td>VI1996A0</td> <td>VITE M5x35 TCEI ZN</td> <td>4.000</td> <td>PZ</td> </tr> <tr> <td>VM2268A0</td> <td>TAPPO COPRI CALAMITA PORTA</td> <td>1.000</td> <td>PZ</td> </tr> <tr> <td>VM2305A0</td> <td>NOTTOLINO FISSAGGIO TAPPI PORTE MM</td> <td>4.000</td> <td>PZ</td> </tr> <tr> <td>VM2957A0</td> <td>ASSEMBLATO TAPPO INF DX PORTA MM -M</td> <td>1.000</td> <td>PZ</td> </tr> </tbody> </table>	Code	Description	Qty	UOM	VI1930A1	VITE 5X20 TRUCIOLARE INOX	4.000	PZ	VI1996A0	VITE M5x35 TCEI ZN	4.000	PZ	VM2268A0	TAPPO COPRI CALAMITA PORTA	1.000	PZ	VM2305A0	NOTTOLINO FISSAGGIO TAPPI PORTE MM	4.000	PZ	VM2957A0	ASSEMBLATO TAPPO INF DX PORTA MM -M	1.000	PZ																					
			Code	Description	Qty	UOM																																												
VI1930A1	VITE 5X20 TRUCIOLARE INOX	4.000	PZ																																															
VI1996A0	VITE M5x35 TCEI ZN	4.000	PZ																																															
VM2268A0	TAPPO COPRI CALAMITA PORTA	1.000	PZ																																															
VM2305A0	NOTTOLINO FISSAGGIO TAPPI PORTE MM	4.000	PZ																																															
VM2957A0	ASSEMBLATO TAPPO INF DX PORTA MM -M	1.000	PZ																																															
K0B1155AR	XECC RIGHT DOOR LOWER BEAM KIT	<table border="1"> <thead> <tr> <th>Code</th> <th>Description</th> <th>Qty</th> <th>UOM</th> </tr> </thead> <tbody> <tr> <td>0B1155A1</td> <td>TRAVERSO INFERIORE PORTA XECC RIGHT</td> <td>1.000</td> <td>PZ</td> </tr> <tr> <td>RC1200A0</td> <td>MOLLA A COMPRESSIO NE Dø4 D10.5 H24</td> <td>2.000</td> <td>PZ</td> </tr> <tr> <td>VI1220A1</td> <td>VITE AUTOFIL. 4.2X11 TCS+ MARUTEX</td> <td>1.000</td> <td>PZ</td> </tr> <tr> <td>VI1996A0</td> <td>VITE M5x35 TCEI ZN</td> <td>7.000</td> <td>PZ</td> </tr> <tr> <td>VM1794A0</td> <td>FASCETTA 430X4.8 PA66 NERA</td> <td>2.000</td> <td>PZ</td> </tr> <tr> <td>VM2261A1</td> <td>TAPPO INF DX PORTA MM</td> <td>1.000</td> <td>PZ</td> </tr> <tr> <td>VM2267A1</td> <td>CORSOIO SISTEMA FERMA VETRO INT</td> <td>1.000</td> <td>PZ</td> </tr> <tr> <td>VM2269A0</td> <td>TAPPO SISTEMA FERMA VETRO INT</td> <td>1.000</td> <td>PZ</td> </tr> <tr> <td>VM2274A0</td> <td>BOCCOLA SCANALATA CORTA</td> <td>1.000</td> <td>PZ</td> </tr> <tr> <td>VM2305A0</td> <td>NOTTOLINO FISSAGGIO TAPPI PORTE MM</td> <td>7.000</td> <td>PZ</td> </tr> <tr> <td>VM2324A0</td> <td>TAPPO INF SX PORTA XECC</td> <td>1.000</td> <td>PZ</td> </tr> </tbody> </table>	Code	Description	Qty	UOM	0B1155A1	TRAVERSO INFERIORE PORTA XECC RIGHT	1.000	PZ	RC1200A0	MOLLA A COMPRESSIO NE Dø4 D10.5 H24	2.000	PZ	VI1220A1	VITE AUTOFIL. 4.2X11 TCS+ MARUTEX	1.000	PZ	VI1996A0	VITE M5x35 TCEI ZN	7.000	PZ	VM1794A0	FASCETTA 430X4.8 PA66 NERA	2.000	PZ	VM2261A1	TAPPO INF DX PORTA MM	1.000	PZ	VM2267A1	CORSOIO SISTEMA FERMA VETRO INT	1.000	PZ	VM2269A0	TAPPO SISTEMA FERMA VETRO INT	1.000	PZ	VM2274A0	BOCCOLA SCANALATA CORTA	1.000	PZ	VM2305A0	NOTTOLINO FISSAGGIO TAPPI PORTE MM	7.000	PZ	VM2324A0	TAPPO INF SX PORTA XECC	1.000	PZ
Code	Description	Qty	UOM																																															
0B1155A1	TRAVERSO INFERIORE PORTA XECC RIGHT	1.000	PZ																																															
RC1200A0	MOLLA A COMPRESSIO NE Dø4 D10.5 H24	2.000	PZ																																															
VI1220A1	VITE AUTOFIL. 4.2X11 TCS+ MARUTEX	1.000	PZ																																															
VI1996A0	VITE M5x35 TCEI ZN	7.000	PZ																																															
VM1794A0	FASCETTA 430X4.8 PA66 NERA	2.000	PZ																																															
VM2261A1	TAPPO INF DX PORTA MM	1.000	PZ																																															
VM2267A1	CORSOIO SISTEMA FERMA VETRO INT	1.000	PZ																																															
VM2269A0	TAPPO SISTEMA FERMA VETRO INT	1.000	PZ																																															
VM2274A0	BOCCOLA SCANALATA CORTA	1.000	PZ																																															
VM2305A0	NOTTOLINO FISSAGGIO TAPPI PORTE MM	7.000	PZ																																															
VM2324A0	TAPPO INF SX PORTA XECC	1.000	PZ																																															

COMPONENT			SPARE PART																																																																													
Code	Description	Image	Code	Description	Kit components																																																																											
VM2267A	CORSOIO SISTEMA FERMA VETRO INT		K0B1155AL	XECC LEFT DOOR LOWER BEAM KIT	<table border="1"> <thead> <tr> <th>Code</th> <th>Description</th> <th>Qty</th> <th>UOM</th> </tr> </thead> <tbody> <tr> <td>0B1155A1</td> <td>TRAVERSO INFERIORE PORTA XECC RIGHT</td> <td>1.000</td> <td>PZ</td> </tr> <tr> <td>RC1200A0</td> <td>MOLLA A COMPRESSIO NE De4 D10.5 H24</td> <td>2.000</td> <td>PZ</td> </tr> <tr> <td>VI1220A1</td> <td>VITE AUTOFIL. 4.2X11 TCS+ MARUTEX</td> <td>1.000</td> <td>PZ</td> </tr> <tr> <td>VI1996A0</td> <td>VITE M5x35 TCEI ZN</td> <td>7.000</td> <td>PZ</td> </tr> <tr> <td>VM1794A0</td> <td>FASCETTA 430X4.8 PA66 NERA</td> <td>2.000</td> <td>PZ</td> </tr> <tr> <td>VM2267A1</td> <td>CORSOIO SISTEMA FERMA VETRO INT</td> <td>1.000</td> <td>PZ</td> </tr> <tr> <td>VM2269A0</td> <td>TAPPO SISTEMA FERMA VETRO INT</td> <td>1.000</td> <td>PZ</td> </tr> <tr> <td>VM2274A0</td> <td>BOCCOLA SCANALATA CORTA</td> <td>1.000</td> <td>PZ</td> </tr> <tr> <td>VM2305A0</td> <td>NOTTOLINO FISSAGGIO TAPPI PORTE MM</td> <td>7.000</td> <td>PZ</td> </tr> <tr> <td>VM2325A0</td> <td>TAPPO SUP SX PORTA XECC</td> <td>1.000</td> <td>PZ</td> </tr> <tr> <td>VM2386A1</td> <td>TAPPO INF SX PORTA MM LEFT</td> <td>1.000</td> <td>PZ</td> </tr> </tbody> </table>	Code	Description	Qty	UOM	0B1155A1	TRAVERSO INFERIORE PORTA XECC RIGHT	1.000	PZ	RC1200A0	MOLLA A COMPRESSIO NE De4 D10.5 H24	2.000	PZ	VI1220A1	VITE AUTOFIL. 4.2X11 TCS+ MARUTEX	1.000	PZ	VI1996A0	VITE M5x35 TCEI ZN	7.000	PZ	VM1794A0	FASCETTA 430X4.8 PA66 NERA	2.000	PZ	VM2267A1	CORSOIO SISTEMA FERMA VETRO INT	1.000	PZ	VM2269A0	TAPPO SISTEMA FERMA VETRO INT	1.000	PZ	VM2274A0	BOCCOLA SCANALATA CORTA	1.000	PZ	VM2305A0	NOTTOLINO FISSAGGIO TAPPI PORTE MM	7.000	PZ	VM2325A0	TAPPO SUP SX PORTA XECC	1.000	PZ	VM2386A1	TAPPO INF SX PORTA MM LEFT	1.000	PZ	K0B1126AR	BAKERTOP MM RIGHT DOOR LOWER BEAM KIT	<table border="1"> <thead> <tr> <th>Code</th> <th>Description</th> <th>Qty</th> <th>UOM</th> </tr> </thead> <tbody> <tr> <td>0B1126A1</td> <td>TRAVERSO INFERIORE PORTA 860 M</td> <td>1.000</td> <td>PZ</td> </tr> <tr> <td>RC1200A0</td> <td>MOLLA A COMPRESSIO NE De4 D10.5 H24</td> <td>2.000</td> <td>PZ</td> </tr> <tr> <td>VI1220A1</td> <td>VITE AUTOFIL. 4.2X11 TCS+ MARUTEX</td> <td>1.000</td> <td>PZ</td> </tr> <tr> <td>VI1996A0</td> <td>VITE M5x35 TCEI ZN</td> <td>7.000</td> <td>PZ</td> </tr> <tr> <td>VM1794A0</td> <td>FASCETTA 430X4.8 PA66 NERA</td> <td>2.000</td> <td>PZ</td> </tr> </tbody> </table>	Code	Description	Qty	UOM	0B1126A1	TRAVERSO INFERIORE PORTA 860 M	1.000	PZ	RC1200A0	MOLLA A COMPRESSIO NE De4 D10.5 H24	2.000	PZ	VI1220A1	VITE AUTOFIL. 4.2X11 TCS+ MARUTEX	1.000	PZ	VI1996A0	VITE M5x35 TCEI ZN	7.000	PZ	VM1794A0	FASCETTA 430X4.8 PA66 NERA	2.000	PZ
			Code	Description	Qty	UOM																																																																										
0B1155A1	TRAVERSO INFERIORE PORTA XECC RIGHT	1.000	PZ																																																																													
RC1200A0	MOLLA A COMPRESSIO NE De4 D10.5 H24	2.000	PZ																																																																													
VI1220A1	VITE AUTOFIL. 4.2X11 TCS+ MARUTEX	1.000	PZ																																																																													
VI1996A0	VITE M5x35 TCEI ZN	7.000	PZ																																																																													
VM1794A0	FASCETTA 430X4.8 PA66 NERA	2.000	PZ																																																																													
VM2267A1	CORSOIO SISTEMA FERMA VETRO INT	1.000	PZ																																																																													
VM2269A0	TAPPO SISTEMA FERMA VETRO INT	1.000	PZ																																																																													
VM2274A0	BOCCOLA SCANALATA CORTA	1.000	PZ																																																																													
VM2305A0	NOTTOLINO FISSAGGIO TAPPI PORTE MM	7.000	PZ																																																																													
VM2325A0	TAPPO SUP SX PORTA XECC	1.000	PZ																																																																													
VM2386A1	TAPPO INF SX PORTA MM LEFT	1.000	PZ																																																																													
Code	Description	Qty	UOM																																																																													
0B1126A1	TRAVERSO INFERIORE PORTA 860 M	1.000	PZ																																																																													
RC1200A0	MOLLA A COMPRESSIO NE De4 D10.5 H24	2.000	PZ																																																																													
VI1220A1	VITE AUTOFIL. 4.2X11 TCS+ MARUTEX	1.000	PZ																																																																													
VI1996A0	VITE M5x35 TCEI ZN	7.000	PZ																																																																													
VM1794A0	FASCETTA 430X4.8 PA66 NERA	2.000	PZ																																																																													

COMPONENT			SPARE PART																																															
Code	Description	Image	Code	Description	Kit components																																													
VM2267A	CORSOIO SISTEMA FERMA VETRO INT		K0B1126AR	BAKERTOP MM RIGHT DOOR LOWER BEAM KIT	<table border="1"> <thead> <tr> <th>Code</th> <th>Description</th> <th>Qty</th> <th>UOM</th> </tr> </thead> <tbody> <tr> <td>VM2259A1</td> <td>TAPPO INF SX PORTA S6</td> <td>1.000</td> <td>PZ</td> </tr> <tr> <td>VM2261A1</td> <td>TAPPO INF DX PORTA MM</td> <td>1.000</td> <td>PZ</td> </tr> <tr> <td>VM2267A1</td> <td>CORSOIO SISTEMA FERMA VETRO INT</td> <td>1.000</td> <td>PZ</td> </tr> <tr> <td>VM2269A0</td> <td>TAPPO SISTEMA FERMA VETRO INT</td> <td>1.000</td> <td>PZ</td> </tr> <tr> <td>VM2274A0</td> <td>BOCCOLA SCANALATA CORTA</td> <td>1.000</td> <td>PZ</td> </tr> <tr> <td>VM2305A0</td> <td>NOTTOLINO FISSAGGIO TAPPI PORTE MM</td> <td>7.000</td> <td>PZ</td> </tr> </tbody> </table>	Code	Description	Qty	UOM	VM2259A1	TAPPO INF SX PORTA S6	1.000	PZ	VM2261A1	TAPPO INF DX PORTA MM	1.000	PZ	VM2267A1	CORSOIO SISTEMA FERMA VETRO INT	1.000	PZ	VM2269A0	TAPPO SISTEMA FERMA VETRO INT	1.000	PZ	VM2274A0	BOCCOLA SCANALATA CORTA	1.000	PZ	VM2305A0	NOTTOLINO FISSAGGIO TAPPI PORTE MM	7.000	PZ																	
			Code	Description	Qty	UOM																																												
VM2259A1	TAPPO INF SX PORTA S6	1.000	PZ																																															
VM2261A1	TAPPO INF DX PORTA MM	1.000	PZ																																															
VM2267A1	CORSOIO SISTEMA FERMA VETRO INT	1.000	PZ																																															
VM2269A0	TAPPO SISTEMA FERMA VETRO INT	1.000	PZ																																															
VM2274A0	BOCCOLA SCANALATA CORTA	1.000	PZ																																															
VM2305A0	NOTTOLINO FISSAGGIO TAPPI PORTE MM	7.000	PZ																																															
K0B1126AL	EU AND 2/1 MM LEFT DOOR LOWER BEAM KIT	<table border="1"> <thead> <tr> <th>Code</th> <th>Description</th> <th>Qty</th> <th>UOM</th> </tr> </thead> <tbody> <tr> <td>0B1126A1</td> <td>TRAVERSO INFERIORE PORTA 860 M</td> <td>1.000</td> <td>PZ</td> </tr> <tr> <td>RC1200A0</td> <td>MOLLA A COMPRESSIO NE Dø4 D10.5 H24</td> <td>2.000</td> <td>PZ</td> </tr> <tr> <td>VI1220A1</td> <td>VITE AUTOFIL. 4.2X11 TCS+ MARUTEX</td> <td>1.000</td> <td>PZ</td> </tr> <tr> <td>VI1996A0</td> <td>VITE M5x35 TCEI ZN</td> <td>7.000</td> <td>PZ</td> </tr> <tr> <td>VM1794A0</td> <td>FASCETTA 430X4.8 PA66 NERA</td> <td>2.000</td> <td>PZ</td> </tr> <tr> <td>VM2267A1</td> <td>CORSOIO SISTEMA FERMA VETRO INT</td> <td>1.000</td> <td>PZ</td> </tr> <tr> <td>VM2269A0</td> <td>TAPPO SISTEMA FERMA VETRO INT</td> <td>1.000</td> <td>PZ</td> </tr> <tr> <td>VM2274A0</td> <td>BOCCOLA SCANALATA CORTA</td> <td>1.000</td> <td>PZ</td> </tr> <tr> <td>VM2305A0</td> <td>NOTTOLINO FISSAGGIO TAPPI PORTE MM</td> <td>7.000</td> <td>PZ</td> </tr> <tr> <td>VM2384A0</td> <td>TAPPO INF DX PORTA MM LEFT</td> <td>1.000</td> <td>PZ</td> </tr> <tr> <td>VM2386A1</td> <td>TAPPO INF SX PORTA MM LEFT</td> <td>1.000</td> <td>PZ</td> </tr> </tbody> </table>	Code	Description	Qty	UOM	0B1126A1	TRAVERSO INFERIORE PORTA 860 M	1.000	PZ	RC1200A0	MOLLA A COMPRESSIO NE Dø4 D10.5 H24	2.000	PZ	VI1220A1	VITE AUTOFIL. 4.2X11 TCS+ MARUTEX	1.000	PZ	VI1996A0	VITE M5x35 TCEI ZN	7.000	PZ	VM1794A0	FASCETTA 430X4.8 PA66 NERA	2.000	PZ	VM2267A1	CORSOIO SISTEMA FERMA VETRO INT	1.000	PZ	VM2269A0	TAPPO SISTEMA FERMA VETRO INT	1.000	PZ	VM2274A0	BOCCOLA SCANALATA CORTA	1.000	PZ	VM2305A0	NOTTOLINO FISSAGGIO TAPPI PORTE MM	7.000	PZ	VM2384A0	TAPPO INF DX PORTA MM LEFT	1.000	PZ	VM2386A1	TAPPO INF SX PORTA MM LEFT	1.000	PZ
Code	Description	Qty	UOM																																															
0B1126A1	TRAVERSO INFERIORE PORTA 860 M	1.000	PZ																																															
RC1200A0	MOLLA A COMPRESSIO NE Dø4 D10.5 H24	2.000	PZ																																															
VI1220A1	VITE AUTOFIL. 4.2X11 TCS+ MARUTEX	1.000	PZ																																															
VI1996A0	VITE M5x35 TCEI ZN	7.000	PZ																																															
VM1794A0	FASCETTA 430X4.8 PA66 NERA	2.000	PZ																																															
VM2267A1	CORSOIO SISTEMA FERMA VETRO INT	1.000	PZ																																															
VM2269A0	TAPPO SISTEMA FERMA VETRO INT	1.000	PZ																																															
VM2274A0	BOCCOLA SCANALATA CORTA	1.000	PZ																																															
VM2305A0	NOTTOLINO FISSAGGIO TAPPI PORTE MM	7.000	PZ																																															
VM2384A0	TAPPO INF DX PORTA MM LEFT	1.000	PZ																																															
VM2386A1	TAPPO INF SX PORTA MM LEFT	1.000	PZ																																															

COMPONENT			SPARE PART																																																																													
Code	Description	Image	Code	Description	Kit components																																																																											
VM2267A	CORSOIO SISTEMA FERMA VETRO INT		K0B1122AR	CHEFTOP MM RIGHT DOOR LOWER BEAM KIT	<table border="1"> <thead> <tr> <th>Code</th> <th>Description</th> <th>Qty</th> <th>UOM</th> </tr> </thead> <tbody> <tr> <td>0B1122A1</td> <td>TRAVERSO INFERIORE PORTA 750 S6</td> <td>1.000</td> <td>PZ</td> </tr> <tr> <td>RC1200A0</td> <td>MOLLA A COMPRESSIO NE De4 D10.5 H24</td> <td>2.000</td> <td>PZ</td> </tr> <tr> <td>V11220A1</td> <td>VITE AUTOFIL. 4.2X11 TCS+ MARUTEX</td> <td>1.000</td> <td>PZ</td> </tr> <tr> <td>V11996A0</td> <td>VITE M5x35 TCEI ZN</td> <td>7.000</td> <td>PZ</td> </tr> <tr> <td>VM2259A1</td> <td>TAPPO INF SX PORTA S6</td> <td>1.000</td> <td>PZ</td> </tr> <tr> <td>VM2261A1</td> <td>TAPPO INF DX PORTA MM</td> <td>1.000</td> <td>PZ</td> </tr> <tr> <td>VM2267A1</td> <td>CORSOIO SISTEMA FERMA VETRO INT</td> <td>1.000</td> <td>PZ</td> </tr> <tr> <td>VM2269A0</td> <td>TAPPO SISTEMA FERMA VETRO INT</td> <td>1.000</td> <td>PZ</td> </tr> <tr> <td>VM2274A0</td> <td>BOCCOLA SCANALATA CORTA</td> <td>1.000</td> <td>PZ</td> </tr> <tr> <td>VM2305A0</td> <td>NOTTOLINO FISSAGGIO TAPPI PORTE MM</td> <td>7.000</td> <td>PZ</td> </tr> </tbody> </table>	Code	Description	Qty	UOM	0B1122A1	TRAVERSO INFERIORE PORTA 750 S6	1.000	PZ	RC1200A0	MOLLA A COMPRESSIO NE De4 D10.5 H24	2.000	PZ	V11220A1	VITE AUTOFIL. 4.2X11 TCS+ MARUTEX	1.000	PZ	V11996A0	VITE M5x35 TCEI ZN	7.000	PZ	VM2259A1	TAPPO INF SX PORTA S6	1.000	PZ	VM2261A1	TAPPO INF DX PORTA MM	1.000	PZ	VM2267A1	CORSOIO SISTEMA FERMA VETRO INT	1.000	PZ	VM2269A0	TAPPO SISTEMA FERMA VETRO INT	1.000	PZ	VM2274A0	BOCCOLA SCANALATA CORTA	1.000	PZ	VM2305A0	NOTTOLINO FISSAGGIO TAPPI PORTE MM	7.000	PZ	K0B1122AL	CHEFTOP MM LEFT DOOR LOWER BEAM KIT	<table border="1"> <thead> <tr> <th>Code</th> <th>Description</th> <th>Qty</th> <th>UOM</th> </tr> </thead> <tbody> <tr> <td>0B1122A1</td> <td>TRAVERSO INFERIORE PORTA 750 S6</td> <td>1.000</td> <td>PZ</td> </tr> <tr> <td>RC1200A0</td> <td>MOLLA A COMPRESSIO NE De4 D10.5 H24</td> <td>2.000</td> <td>PZ</td> </tr> <tr> <td>V11220A1</td> <td>VITE AUTOFIL. 4.2X11 TCS+ MARUTEX</td> <td>1.000</td> <td>PZ</td> </tr> <tr> <td>V11996A0</td> <td>VITE M5x35 TCEI ZN</td> <td>7.000</td> <td>PZ</td> </tr> <tr> <td>VM1794A0</td> <td>FASCETTA 430X4.8 PA66 NERA</td> <td>2.000</td> <td>PZ</td> </tr> <tr> <td>VM2267A1</td> <td>CORSOIO SISTEMA FERMA VETRO INT</td> <td>1.000</td> <td>PZ</td> </tr> </tbody> </table>	Code	Description	Qty	UOM	0B1122A1	TRAVERSO INFERIORE PORTA 750 S6	1.000	PZ	RC1200A0	MOLLA A COMPRESSIO NE De4 D10.5 H24	2.000	PZ	V11220A1	VITE AUTOFIL. 4.2X11 TCS+ MARUTEX	1.000	PZ	V11996A0	VITE M5x35 TCEI ZN	7.000	PZ	VM1794A0	FASCETTA 430X4.8 PA66 NERA	2.000	PZ	VM2267A1	CORSOIO SISTEMA FERMA VETRO INT	1.000	PZ
			Code	Description	Qty	UOM																																																																										
0B1122A1	TRAVERSO INFERIORE PORTA 750 S6	1.000	PZ																																																																													
RC1200A0	MOLLA A COMPRESSIO NE De4 D10.5 H24	2.000	PZ																																																																													
V11220A1	VITE AUTOFIL. 4.2X11 TCS+ MARUTEX	1.000	PZ																																																																													
V11996A0	VITE M5x35 TCEI ZN	7.000	PZ																																																																													
VM2259A1	TAPPO INF SX PORTA S6	1.000	PZ																																																																													
VM2261A1	TAPPO INF DX PORTA MM	1.000	PZ																																																																													
VM2267A1	CORSOIO SISTEMA FERMA VETRO INT	1.000	PZ																																																																													
VM2269A0	TAPPO SISTEMA FERMA VETRO INT	1.000	PZ																																																																													
VM2274A0	BOCCOLA SCANALATA CORTA	1.000	PZ																																																																													
VM2305A0	NOTTOLINO FISSAGGIO TAPPI PORTE MM	7.000	PZ																																																																													
Code	Description	Qty	UOM																																																																													
0B1122A1	TRAVERSO INFERIORE PORTA 750 S6	1.000	PZ																																																																													
RC1200A0	MOLLA A COMPRESSIO NE De4 D10.5 H24	2.000	PZ																																																																													
V11220A1	VITE AUTOFIL. 4.2X11 TCS+ MARUTEX	1.000	PZ																																																																													
V11996A0	VITE M5x35 TCEI ZN	7.000	PZ																																																																													
VM1794A0	FASCETTA 430X4.8 PA66 NERA	2.000	PZ																																																																													
VM2267A1	CORSOIO SISTEMA FERMA VETRO INT	1.000	PZ																																																																													

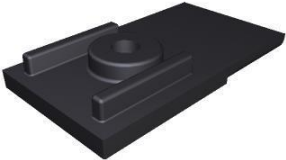
COMPONENT			SPARE PART																																		
Code	Description	Image	Code	Description	Kit components																																
VM2267A	CORSOIO SISTEMA FERMA VETRO INT		K0B1122AL	CHEFTOP MM LEFT DOOR LOWER BEAM KIT	<table border="1"> <thead> <tr> <th>Code</th> <th>Description</th> <th>Qty</th> <th>UOM</th> </tr> </thead> <tbody> <tr> <td>VM2269A0</td> <td>TAPPO SISTEMA FERMA VETRO INT</td> <td>1.000</td> <td>PZ</td> </tr> <tr> <td>VM2274A0</td> <td>BOCCOLA SCANALATA CORTA</td> <td>1.000</td> <td>PZ</td> </tr> <tr> <td>VM2305A0</td> <td>NOTTOLINO FISSAGGIO TAPPI PORTE MM</td> <td>7.000</td> <td>PZ</td> </tr> <tr> <td>VM2384A0</td> <td>TAPPO INF DX PORTA MM LEFT</td> <td>1.000</td> <td>PZ</td> </tr> <tr> <td>VM2386A1</td> <td>TAPPO INF SX PORTA MM LEFT</td> <td>1.000</td> <td>PZ</td> </tr> </tbody> </table>	Code	Description	Qty	UOM	VM2269A0	TAPPO SISTEMA FERMA VETRO INT	1.000	PZ	VM2274A0	BOCCOLA SCANALATA CORTA	1.000	PZ	VM2305A0	NOTTOLINO FISSAGGIO TAPPI PORTE MM	7.000	PZ	VM2384A0	TAPPO INF DX PORTA MM LEFT	1.000	PZ	VM2386A1	TAPPO INF SX PORTA MM LEFT	1.000	PZ								
					Code	Description	Qty	UOM																													
					VM2269A0	TAPPO SISTEMA FERMA VETRO INT	1.000	PZ																													
					VM2274A0	BOCCOLA SCANALATA CORTA	1.000	PZ																													
					VM2305A0	NOTTOLINO FISSAGGIO TAPPI PORTE MM	7.000	PZ																													
VM2384A0	TAPPO INF DX PORTA MM LEFT	1.000	PZ																																		
VM2386A1	TAPPO INF SX PORTA MM LEFT	1.000	PZ																																		
VM2269B	VM2269B1		OUTOFPRODUCTIO KVM2386B	ITEM OUT OF PRODUCTION MM -M LEFT DOOR LEFT LOWER CAP KI	<table border="1"> <thead> <tr> <th>Code</th> <th>Description</th> <th>Qty</th> <th>UOM</th> </tr> </thead> <tbody> <tr> <td>VE1030A1</td> <td>CALAMITA D=22,9mm PER MICROPORTA</td> <td>1.000</td> <td>PZ</td> </tr> <tr> <td>VI1220A1</td> <td>VITE AUTOFIL. 4.2X11 TCS+ MARUTEX</td> <td>1.000</td> <td>PZ</td> </tr> <tr> <td>VI1930A1</td> <td>VITE 5X20 TRUCIOLARE INOX</td> <td>4.000</td> <td>PZ</td> </tr> <tr> <td>VI1996A0</td> <td>VITE M5x35 TCEI ZN</td> <td>4.000</td> <td>PZ</td> </tr> <tr> <td>VM2268A0</td> <td>TAPPO COPRI CALAMITA PORTA</td> <td>1.000</td> <td>PZ</td> </tr> <tr> <td>VM2305A0</td> <td>NOTTOLINO FISSAGGIO TAPPI PORTE MM</td> <td>4.000</td> <td>PZ</td> </tr> <tr> <td>VM2960A0</td> <td>ASSEMBLATO TAPPO INF SX PORTA S6 LEF</td> <td>1.000</td> <td>PZ</td> </tr> </tbody> </table>	Code	Description	Qty	UOM	VE1030A1	CALAMITA D=22,9mm PER MICROPORTA	1.000	PZ	VI1220A1	VITE AUTOFIL. 4.2X11 TCS+ MARUTEX	1.000	PZ	VI1930A1	VITE 5X20 TRUCIOLARE INOX	4.000	PZ	VI1996A0	VITE M5x35 TCEI ZN	4.000	PZ	VM2268A0	TAPPO COPRI CALAMITA PORTA	1.000	PZ	VM2305A0	NOTTOLINO FISSAGGIO TAPPI PORTE MM	4.000	PZ	VM2960A0	ASSEMBLATO TAPPO INF SX PORTA S6 LEF	1.000	PZ
					Code	Description	Qty	UOM																													
					VE1030A1	CALAMITA D=22,9mm PER MICROPORTA	1.000	PZ																													
					VI1220A1	VITE AUTOFIL. 4.2X11 TCS+ MARUTEX	1.000	PZ																													
					VI1930A1	VITE 5X20 TRUCIOLARE INOX	4.000	PZ																													
VI1996A0	VITE M5x35 TCEI ZN	4.000	PZ																																		
VM2268A0	TAPPO COPRI CALAMITA PORTA	1.000	PZ																																		
VM2305A0	NOTTOLINO FISSAGGIO TAPPI PORTE MM	4.000	PZ																																		
VM2960A0	ASSEMBLATO TAPPO INF SX PORTA S6 LEF	1.000	PZ																																		
KVM2385B	MM -M LEFT DOOR LEFT UPPER CAP KI	<table border="1"> <thead> <tr> <th>Code</th> <th>Description</th> <th>Qty</th> <th>UOM</th> </tr> </thead> <tbody> <tr> <td>VE1030A1</td> <td>CALAMITA D=22,9mm PER MICROPORTA</td> <td>1.000</td> <td>PZ</td> </tr> <tr> <td>VI1220A1</td> <td>VITE AUTOFIL. 4.2X11 TCS+ MARUTEX</td> <td>1.000</td> <td>PZ</td> </tr> <tr> <td>VI1930A1</td> <td>VITE 5X20 TRUCIOLARE INOX</td> <td>4.000</td> <td>PZ</td> </tr> </tbody> </table>	Code	Description	Qty	UOM	VE1030A1	CALAMITA D=22,9mm PER MICROPORTA	1.000	PZ	VI1220A1	VITE AUTOFIL. 4.2X11 TCS+ MARUTEX	1.000	PZ	VI1930A1	VITE 5X20 TRUCIOLARE INOX	4.000	PZ																			
		Code	Description	Qty	UOM																																
		VE1030A1	CALAMITA D=22,9mm PER MICROPORTA	1.000	PZ																																
VI1220A1	VITE AUTOFIL. 4.2X11 TCS+ MARUTEX	1.000	PZ																																		
VI1930A1	VITE 5X20 TRUCIOLARE INOX	4.000	PZ																																		

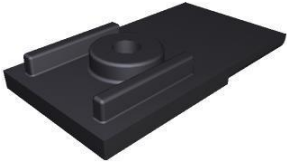
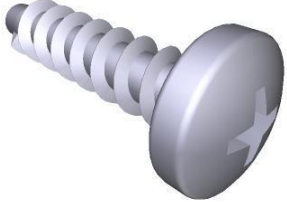
COMPONENT			SPARE PART																															
Code	Description	Image	Code	Description	Kit components																													
VM2269B	VM2269B1		KVM2385B	MM -M LEFT DOOR LEFT UPPER CAP KI	<table border="1"> <thead> <tr> <th>Code</th> <th>Description</th> <th>Qty</th> <th>UOM</th> </tr> </thead> <tbody> <tr> <td>VI1996A0</td> <td>VITE M5x35 TCEI ZN</td> <td>4.000</td> <td>PZ</td> </tr> <tr> <td>VM2268A0</td> <td>TAPPO COPRI CALAMITA PORTA</td> <td>1.000</td> <td>PZ</td> </tr> <tr> <td>VM2305A0</td> <td>NOTTOLINO FISSAGGIO TAPPI PORTE MM</td> <td>4.000</td> <td>PZ</td> </tr> <tr> <td>VM2959A0</td> <td>ASSEMBLATO TAPPO SUP SX PORTA MM LEFT</td> <td>1.000</td> <td>PZ</td> </tr> </tbody> </table>	Code	Description	Qty	UOM	VI1996A0	VITE M5x35 TCEI ZN	4.000	PZ	VM2268A0	TAPPO COPRI CALAMITA PORTA	1.000	PZ	VM2305A0	NOTTOLINO FISSAGGIO TAPPI PORTE MM	4.000	PZ	VM2959A0	ASSEMBLATO TAPPO SUP SX PORTA MM LEFT	1.000	PZ									
			Code	Description	Qty	UOM																												
VI1996A0	VITE M5x35 TCEI ZN	4.000	PZ																															
VM2268A0	TAPPO COPRI CALAMITA PORTA	1.000	PZ																															
VM2305A0	NOTTOLINO FISSAGGIO TAPPI PORTE MM	4.000	PZ																															
VM2959A0	ASSEMBLATO TAPPO SUP SX PORTA MM LEFT	1.000	PZ																															
KVM2261B	MIND.MAPS -M DOOR RIGHT LOWER CAP KIT	<table border="1"> <thead> <tr> <th>Code</th> <th>Description</th> <th>Qty</th> <th>UOM</th> </tr> </thead> <tbody> <tr> <td>VE1030A1</td> <td>CALAMITA D=22,9mm PER MICROPORTA</td> <td>1.000</td> <td>PZ</td> </tr> <tr> <td>VI1220A1</td> <td>VITE AUTOFIL. 4.2X11 TCS+ MARUTEX</td> <td>1.000</td> <td>PZ</td> </tr> <tr> <td>VI1930A1</td> <td>VITE 5X20 TRUCIOLARE INOX</td> <td>4.000</td> <td>PZ</td> </tr> <tr> <td>VI1996A0</td> <td>VITE M5x35 TCEI ZN</td> <td>4.000</td> <td>PZ</td> </tr> <tr> <td>VM2268A0</td> <td>TAPPO COPRI CALAMITA PORTA</td> <td>1.000</td> <td>PZ</td> </tr> <tr> <td>VM2305A0</td> <td>NOTTOLINO FISSAGGIO TAPPI PORTE MM</td> <td>4.000</td> <td>PZ</td> </tr> <tr> <td>VM2957A0</td> <td>ASSEMBLATO TAPPO INF DX PORTA MM -M</td> <td>1.000</td> <td>PZ</td> </tr> </tbody> </table>	Code	Description	Qty	UOM	VE1030A1	CALAMITA D=22,9mm PER MICROPORTA	1.000	PZ	VI1220A1	VITE AUTOFIL. 4.2X11 TCS+ MARUTEX	1.000	PZ	VI1930A1	VITE 5X20 TRUCIOLARE INOX	4.000	PZ	VI1996A0	VITE M5x35 TCEI ZN	4.000	PZ	VM2268A0	TAPPO COPRI CALAMITA PORTA	1.000	PZ	VM2305A0	NOTTOLINO FISSAGGIO TAPPI PORTE MM	4.000	PZ	VM2957A0	ASSEMBLATO TAPPO INF DX PORTA MM -M	1.000	PZ
Code	Description	Qty	UOM																															
VE1030A1	CALAMITA D=22,9mm PER MICROPORTA	1.000	PZ																															
VI1220A1	VITE AUTOFIL. 4.2X11 TCS+ MARUTEX	1.000	PZ																															
VI1930A1	VITE 5X20 TRUCIOLARE INOX	4.000	PZ																															
VI1996A0	VITE M5x35 TCEI ZN	4.000	PZ																															
VM2268A0	TAPPO COPRI CALAMITA PORTA	1.000	PZ																															
VM2305A0	NOTTOLINO FISSAGGIO TAPPI PORTE MM	4.000	PZ																															
VM2957A0	ASSEMBLATO TAPPO INF DX PORTA MM -M	1.000	PZ																															
VI1174A	VITE 5X20 PER PLASTICA ZN-NI		VI1174A0	VITE 5X20 PER PLASTICA ZN-NI																														

COMPONENT			SPARE PART																										
Code	Description	Image	Code	Description	Kit components																								
VI1996A	VITE M5x35 TCEI ZN		VI1996A0	VITE M5x35 TCEI ZN																									
VM2275A	BOCCOLA LISCIA CORTA		KVM2275A	SMOOTH PIN BUSHING KIT	<table border="1"> <thead> <tr> <th>Code</th> <th>Description</th> <th>Qty</th> <th>UOM</th> </tr> </thead> <tbody> <tr> <td>VM2275A0</td> <td>BOCCOLA LISCIA CORTA</td> <td>1.000</td> <td>PZ</td> </tr> </tbody> </table>	Code	Description	Qty	UOM	VM2275A0	BOCCOLA LISCIA CORTA	1.000	PZ																
Code	Description	Qty	UOM																										
VM2275A0	BOCCOLA LISCIA CORTA	1.000	PZ																										
VM2305A	NOTTOLINO FISSAGGIO TAPPI PORTE MM		KVM2305A	MM FIXING DOOR THUB SCREWS 10 PCS KIT	<table border="1"> <thead> <tr> <th>Code</th> <th>Description</th> <th>Qty</th> <th>UOM</th> </tr> </thead> <tbody> <tr> <td>VM2305A0</td> <td>NOTTOLINO FISSAGGIO TAPPI PORTE MM</td> <td>10.000</td> <td>PZ</td> </tr> </tbody> </table>	Code	Description	Qty	UOM	VM2305A0	NOTTOLINO FISSAGGIO TAPPI PORTE MM	10.000	PZ																
Code	Description	Qty	UOM																										
VM2305A0	NOTTOLINO FISSAGGIO TAPPI PORTE MM	10.000	PZ																										
VM2958A	ASSEMBLATO TAPPO SUP SX PORTA MM -M		KVM2260B	MM M RIGHT DOOR -LEFT UPPER CAP KI	<table border="1"> <thead> <tr> <th>Code</th> <th>Description</th> <th>Qty</th> <th>UOM</th> </tr> </thead> <tbody> <tr> <td>VI1930A1</td> <td>VITE 5X20 TRUCIOLARE INOX</td> <td>4.000</td> <td>PZ</td> </tr> <tr> <td>VI1996A0</td> <td>VITE M5x35 TCEI ZN</td> <td>2.000</td> <td>PZ</td> </tr> <tr> <td>VM2275A0</td> <td>BOCCOLA LISCIA CORTA</td> <td>1.000</td> <td>PZ</td> </tr> <tr> <td>VM2305A0</td> <td>NOTTOLINO FISSAGGIO TAPPI PORTE MM</td> <td>3.000</td> <td>PZ</td> </tr> <tr> <td>VM2958A0</td> <td>ASSEMBLATO TAPPO SUP SX PORTA MM -M</td> <td>1.000</td> <td>PZ</td> </tr> </tbody> </table>	Code	Description	Qty	UOM	VI1930A1	VITE 5X20 TRUCIOLARE INOX	4.000	PZ	VI1996A0	VITE M5x35 TCEI ZN	2.000	PZ	VM2275A0	BOCCOLA LISCIA CORTA	1.000	PZ	VM2305A0	NOTTOLINO FISSAGGIO TAPPI PORTE MM	3.000	PZ	VM2958A0	ASSEMBLATO TAPPO SUP SX PORTA MM -M	1.000	PZ
Code	Description	Qty	UOM																										
VI1930A1	VITE 5X20 TRUCIOLARE INOX	4.000	PZ																										
VI1996A0	VITE M5x35 TCEI ZN	2.000	PZ																										
VM2275A0	BOCCOLA LISCIA CORTA	1.000	PZ																										
VM2305A0	NOTTOLINO FISSAGGIO TAPPI PORTE MM	3.000	PZ																										
VM2958A0	ASSEMBLATO TAPPO SUP SX PORTA MM -M	1.000	PZ																										

COMPONENT			SPARE PART																										
Code	Description	Image	Code	Description	Kit components																								
VM2260B	VM2260B1		OUTOFPRODUCTIO	ITEM OUT OF PRODUCTION																									
VP1081A	TAPPO SUP CERNIERA VETRO INTERNO SUP		KVM2260B	MM M RIGHT DOOR -LEFT UPPER CAP KI	<table border="1"> <thead> <tr> <th>Code</th> <th>Description</th> <th>Qty</th> <th>UOM</th> </tr> </thead> <tbody> <tr> <td>VI1930A1</td> <td>VITE 5X20 TRUCIOLARE INOX</td> <td>4.000</td> <td>PZ</td> </tr> <tr> <td>VI1996A0</td> <td>VITE M5x35 TCEI ZN</td> <td>2.000</td> <td>PZ</td> </tr> <tr> <td>VM2275A0</td> <td>BOCCOLA LISCIA CORTA</td> <td>1.000</td> <td>PZ</td> </tr> <tr> <td>VM2305A0</td> <td>NOTTOLINO FISSAGGIO TAPPI PORTE MM</td> <td>3.000</td> <td>PZ</td> </tr> <tr> <td>VM2958A0</td> <td>ASSEMBLATO TAPPO SUP SX PORTA MM -M</td> <td>1.000</td> <td>PZ</td> </tr> </tbody> </table>	Code	Description	Qty	UOM	VI1930A1	VITE 5X20 TRUCIOLARE INOX	4.000	PZ	VI1996A0	VITE M5x35 TCEI ZN	2.000	PZ	VM2275A0	BOCCOLA LISCIA CORTA	1.000	PZ	VM2305A0	NOTTOLINO FISSAGGIO TAPPI PORTE MM	3.000	PZ	VM2958A0	ASSEMBLATO TAPPO SUP SX PORTA MM -M	1.000	PZ
Code	Description	Qty	UOM																										
VI1930A1	VITE 5X20 TRUCIOLARE INOX	4.000	PZ																										
VI1996A0	VITE M5x35 TCEI ZN	2.000	PZ																										
VM2275A0	BOCCOLA LISCIA CORTA	1.000	PZ																										
VM2305A0	NOTTOLINO FISSAGGIO TAPPI PORTE MM	3.000	PZ																										
VM2958A0	ASSEMBLATO TAPPO SUP SX PORTA MM -M	1.000	PZ																										
VI1174A	VITE 5X20 PER PLASTICA ZN-NI		VI1174A0	VITE 5X20 PER PLASTICA ZN-NI																									
VI1996A	VITE M5x35 TCEI ZN		VI1996A0	VITE M5x35 TCEI ZN																									



COMPONENT			SPARE PART																																						
Code	Description	Image	Code	Description	Kit components																																				
VM2259B	TAPPO INF SX PORTA S6		KVM2259B	MM -M RIGHT DOOR LEFT LOWER CAP KI	<table border="1"> <thead> <tr> <th>Code</th> <th>Description</th> <th>Qty</th> <th>UOM</th> </tr> </thead> <tbody> <tr> <td>VI1103A0</td> <td>VITE PER PLASTICA 4X12 TPBS+ ZN-NI</td> <td>1.000</td> <td>PZ</td> </tr> <tr> <td>VI1930A1</td> <td>VITE 5X20 TRUCIOLARE INOX</td> <td>4.000</td> <td>PZ</td> </tr> <tr> <td>VI1996A0</td> <td>VITE M5x35 TCEI ZN</td> <td>3.000</td> <td>PZ</td> </tr> <tr> <td>VM2259B0</td> <td>TAPPO INF SX PORTA S6</td> <td>1.000</td> <td>PZ</td> </tr> <tr> <td>VM2274A0</td> <td>BOCCOLA SCANALATA CORTA</td> <td>1.000</td> <td>PZ</td> </tr> <tr> <td>VM2305A0</td> <td>NOTTOLINO FISSAGGIO TAPPI PORTE MM</td> <td>3.000</td> <td>PZ</td> </tr> <tr> <td>VP1080A0</td> <td>TAPPO SUP CERNIERA VETRO INTERNO INF</td> <td>1.000</td> <td>PZ</td> </tr> </tbody> </table>	Code	Description	Qty	UOM	VI1103A0	VITE PER PLASTICA 4X12 TPBS+ ZN-NI	1.000	PZ	VI1930A1	VITE 5X20 TRUCIOLARE INOX	4.000	PZ	VI1996A0	VITE M5x35 TCEI ZN	3.000	PZ	VM2259B0	TAPPO INF SX PORTA S6	1.000	PZ	VM2274A0	BOCCOLA SCANALATA CORTA	1.000	PZ	VM2305A0	NOTTOLINO FISSAGGIO TAPPI PORTE MM	3.000	PZ	VP1080A0	TAPPO SUP CERNIERA VETRO INTERNO INF	1.000	PZ				
Code	Description	Qty	UOM																																						
VI1103A0	VITE PER PLASTICA 4X12 TPBS+ ZN-NI	1.000	PZ																																						
VI1930A1	VITE 5X20 TRUCIOLARE INOX	4.000	PZ																																						
VI1996A0	VITE M5x35 TCEI ZN	3.000	PZ																																						
VM2259B0	TAPPO INF SX PORTA S6	1.000	PZ																																						
VM2274A0	BOCCOLA SCANALATA CORTA	1.000	PZ																																						
VM2305A0	NOTTOLINO FISSAGGIO TAPPI PORTE MM	3.000	PZ																																						
VP1080A0	TAPPO SUP CERNIERA VETRO INTERNO INF	1.000	PZ																																						
VM2274A	BOCCOLA SCANALATA CORTA		KVM2274A	GROOVED PIN BUSHING KIT	<table border="1"> <thead> <tr> <th>Code</th> <th>Description</th> <th>Qty</th> <th>UOM</th> </tr> </thead> <tbody> <tr> <td>VM2274A0</td> <td>BOCCOLA SCANALATA CORTA</td> <td>1.000</td> <td>PZ</td> </tr> </tbody> </table>	Code	Description	Qty	UOM	VM2274A0	BOCCOLA SCANALATA CORTA	1.000	PZ																												
Code	Description	Qty	UOM																																						
VM2274A0	BOCCOLA SCANALATA CORTA	1.000	PZ																																						
			K0B1126AR	BAKERTOP MM RIGHT DOOR LOWER BEAM KIT	<table border="1"> <thead> <tr> <th>Code</th> <th>Description</th> <th>Qty</th> <th>UOM</th> </tr> </thead> <tbody> <tr> <td>0B1126A1</td> <td>TRAVERSO INFERIORE PORTA 860 M</td> <td>1.000</td> <td>PZ</td> </tr> <tr> <td>RC1200A0</td> <td>MOLLA A COMPRESSIO NE D=4 D10.5 H24</td> <td>2.000</td> <td>PZ</td> </tr> <tr> <td>VI1220A1</td> <td>VITE AUTOFIL. 4.2X11 TCS+ MARUTEX</td> <td>1.000</td> <td>PZ</td> </tr> <tr> <td>VI1996A0</td> <td>VITE M5x35 TCEI ZN</td> <td>7.000</td> <td>PZ</td> </tr> <tr> <td>VM1794A0</td> <td>FASCETTA 430X4.8 PA66 NERA</td> <td>2.000</td> <td>PZ</td> </tr> <tr> <td>VM2259A1</td> <td>TAPPO INF SX PORTA S6</td> <td>1.000</td> <td>PZ</td> </tr> <tr> <td>VM2261A1</td> <td>TAPPO INF DX PORTA MM</td> <td>1.000</td> <td>PZ</td> </tr> <tr> <td>VM2267A1</td> <td>CORSOIO SISTEMA FERMA VETRO INT</td> <td>1.000</td> <td>PZ</td> </tr> </tbody> </table>	Code	Description	Qty	UOM	0B1126A1	TRAVERSO INFERIORE PORTA 860 M	1.000	PZ	RC1200A0	MOLLA A COMPRESSIO NE D=4 D10.5 H24	2.000	PZ	VI1220A1	VITE AUTOFIL. 4.2X11 TCS+ MARUTEX	1.000	PZ	VI1996A0	VITE M5x35 TCEI ZN	7.000	PZ	VM1794A0	FASCETTA 430X4.8 PA66 NERA	2.000	PZ	VM2259A1	TAPPO INF SX PORTA S6	1.000	PZ	VM2261A1	TAPPO INF DX PORTA MM	1.000	PZ	VM2267A1	CORSOIO SISTEMA FERMA VETRO INT	1.000	PZ
Code	Description	Qty	UOM																																						
0B1126A1	TRAVERSO INFERIORE PORTA 860 M	1.000	PZ																																						
RC1200A0	MOLLA A COMPRESSIO NE D=4 D10.5 H24	2.000	PZ																																						
VI1220A1	VITE AUTOFIL. 4.2X11 TCS+ MARUTEX	1.000	PZ																																						
VI1996A0	VITE M5x35 TCEI ZN	7.000	PZ																																						
VM1794A0	FASCETTA 430X4.8 PA66 NERA	2.000	PZ																																						
VM2259A1	TAPPO INF SX PORTA S6	1.000	PZ																																						
VM2261A1	TAPPO INF DX PORTA MM	1.000	PZ																																						
VM2267A1	CORSOIO SISTEMA FERMA VETRO INT	1.000	PZ																																						





COMPONENT			SPARE PART																																															
Code	Description	Image	Code	Description	Kit components																																													
VM2274A	BOCCOLA SCANALATA CORTA		K0B1126AR	BAKERTOP MM RIGHT DOOR LOWER BEAM KIT	<table border="1"> <thead> <tr> <th>Code</th> <th>Description</th> <th>Qty</th> <th>UOM</th> </tr> </thead> <tbody> <tr> <td>VM2269A0</td> <td>TAPPO SISTEMA FERMA VETRO INT</td> <td>1.000</td> <td>PZ</td> </tr> <tr> <td>VM2274A0</td> <td>BOCCOLA SCANALATA CORTA</td> <td>1.000</td> <td>PZ</td> </tr> <tr> <td>VM2305A0</td> <td>NOTTOLINO FISSAGGIO TAPPI PORTE MM</td> <td>7.000</td> <td>PZ</td> </tr> </tbody> </table>	Code	Description	Qty	UOM	VM2269A0	TAPPO SISTEMA FERMA VETRO INT	1.000	PZ	VM2274A0	BOCCOLA SCANALATA CORTA	1.000	PZ	VM2305A0	NOTTOLINO FISSAGGIO TAPPI PORTE MM	7.000	PZ																													
			Code	Description	Qty	UOM																																												
VM2269A0	TAPPO SISTEMA FERMA VETRO INT	1.000	PZ																																															
VM2274A0	BOCCOLA SCANALATA CORTA	1.000	PZ																																															
VM2305A0	NOTTOLINO FISSAGGIO TAPPI PORTE MM	7.000	PZ																																															
K0B1126AL	EU AND 2/1 MM LEFT DOOR LOWER BEAM KIT	<table border="1"> <thead> <tr> <th>Code</th> <th>Description</th> <th>Qty</th> <th>UOM</th> </tr> </thead> <tbody> <tr> <td>0B1126A1</td> <td>TRAVERSO INFERIORE PORTA 860 M</td> <td>1.000</td> <td>PZ</td> </tr> <tr> <td>RC1200A0</td> <td>MOLLA A COMPRESSIO NE De4 D10.5 H24</td> <td>2.000</td> <td>PZ</td> </tr> <tr> <td>V11220A1</td> <td>VITE AUTOFIL. 4.2X11 TCS+ MARUTEX</td> <td>1.000</td> <td>PZ</td> </tr> <tr> <td>V11996A0</td> <td>VITE M5x35 TCEI ZN</td> <td>7.000</td> <td>PZ</td> </tr> <tr> <td>VM1794A0</td> <td>FASCETTA 430X4.8 PA66 NERA</td> <td>2.000</td> <td>PZ</td> </tr> <tr> <td>VM2267A1</td> <td>CORSOIO SISTEMA FERMA VETRO INT</td> <td>1.000</td> <td>PZ</td> </tr> <tr> <td>VM2269A0</td> <td>TAPPO SISTEMA FERMA VETRO INT</td> <td>1.000</td> <td>PZ</td> </tr> <tr> <td>VM2274A0</td> <td>BOCCOLA SCANALATA CORTA</td> <td>1.000</td> <td>PZ</td> </tr> <tr> <td>VM2305A0</td> <td>NOTTOLINO FISSAGGIO TAPPI PORTE MM</td> <td>7.000</td> <td>PZ</td> </tr> <tr> <td>VM2384A0</td> <td>TAPPO INF DX PORTA MM LEFT</td> <td>1.000</td> <td>PZ</td> </tr> <tr> <td>VM2386A1</td> <td>TAPPO INF SX PORTA MM LEFT</td> <td>1.000</td> <td>PZ</td> </tr> </tbody> </table>	Code	Description	Qty	UOM	0B1126A1	TRAVERSO INFERIORE PORTA 860 M	1.000	PZ	RC1200A0	MOLLA A COMPRESSIO NE De4 D10.5 H24	2.000	PZ	V11220A1	VITE AUTOFIL. 4.2X11 TCS+ MARUTEX	1.000	PZ	V11996A0	VITE M5x35 TCEI ZN	7.000	PZ	VM1794A0	FASCETTA 430X4.8 PA66 NERA	2.000	PZ	VM2267A1	CORSOIO SISTEMA FERMA VETRO INT	1.000	PZ	VM2269A0	TAPPO SISTEMA FERMA VETRO INT	1.000	PZ	VM2274A0	BOCCOLA SCANALATA CORTA	1.000	PZ	VM2305A0	NOTTOLINO FISSAGGIO TAPPI PORTE MM	7.000	PZ	VM2384A0	TAPPO INF DX PORTA MM LEFT	1.000	PZ	VM2386A1	TAPPO INF SX PORTA MM LEFT	1.000	PZ
Code	Description	Qty	UOM																																															
0B1126A1	TRAVERSO INFERIORE PORTA 860 M	1.000	PZ																																															
RC1200A0	MOLLA A COMPRESSIO NE De4 D10.5 H24	2.000	PZ																																															
V11220A1	VITE AUTOFIL. 4.2X11 TCS+ MARUTEX	1.000	PZ																																															
V11996A0	VITE M5x35 TCEI ZN	7.000	PZ																																															
VM1794A0	FASCETTA 430X4.8 PA66 NERA	2.000	PZ																																															
VM2267A1	CORSOIO SISTEMA FERMA VETRO INT	1.000	PZ																																															
VM2269A0	TAPPO SISTEMA FERMA VETRO INT	1.000	PZ																																															
VM2274A0	BOCCOLA SCANALATA CORTA	1.000	PZ																																															
VM2305A0	NOTTOLINO FISSAGGIO TAPPI PORTE MM	7.000	PZ																																															
VM2384A0	TAPPO INF DX PORTA MM LEFT	1.000	PZ																																															
VM2386A1	TAPPO INF SX PORTA MM LEFT	1.000	PZ																																															
K0B1122AR	CHEFTOP MM RIGHT DOOR LOWER BEAM KIT	<table border="1"> <thead> <tr> <th>Code</th> <th>Description</th> <th>Qty</th> <th>UOM</th> </tr> </thead> <tbody> <tr> <td>0B1122A1</td> <td>TRAVERSO INFERIORE PORTA 750 S6</td> <td>1.000</td> <td>PZ</td> </tr> </tbody> </table>	Code	Description	Qty	UOM	0B1122A1	TRAVERSO INFERIORE PORTA 750 S6	1.000	PZ																																								
Code	Description	Qty	UOM																																															
0B1122A1	TRAVERSO INFERIORE PORTA 750 S6	1.000	PZ																																															



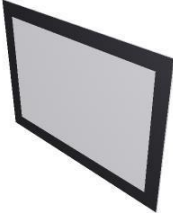

COMPONENT			SPARE PART																																																																													
Code	Description	Image	Code	Description	Kit components																																																																											
VM2274A	BOCCOLA SCANALATA CORTA		K0B1122AR	CHEFTOP MM RIGHT DOOR LOWER BEAM KIT	<table border="1"> <thead> <tr> <th>Code</th> <th>Description</th> <th>Qty</th> <th>UOM</th> </tr> </thead> <tbody> <tr> <td>RC1200A0</td> <td>MOLLA A COMPRESSIO NE De4 D10.5 H24</td> <td>2.000</td> <td>PZ</td> </tr> <tr> <td>V11220A1</td> <td>VITE AUTOFIL. 4.2X11 TCS+ MARUTEX</td> <td>1.000</td> <td>PZ</td> </tr> <tr> <td>V11996A0</td> <td>VITE M5x35 TCEI ZN</td> <td>7.000</td> <td>PZ</td> </tr> <tr> <td>VM2259A1</td> <td>TAPPO INF SX PORTA S6</td> <td>1.000</td> <td>PZ</td> </tr> <tr> <td>VM2261A1</td> <td>TAPPO INF DX PORTA MM</td> <td>1.000</td> <td>PZ</td> </tr> <tr> <td>VM2267A1</td> <td>CORSOIO SISTEMA FERMA VETRO INT</td> <td>1.000</td> <td>PZ</td> </tr> <tr> <td>VM2269A0</td> <td>TAPPO SISTEMA FERMA VETRO INT</td> <td>1.000</td> <td>PZ</td> </tr> <tr> <td>VM2274A0</td> <td>BOCCOLA SCANALATA CORTA</td> <td>1.000</td> <td>PZ</td> </tr> <tr> <td>VM2305A0</td> <td>NOTTOLINO FISSAGGIO TAPPI PORTE MM</td> <td>7.000</td> <td>PZ</td> </tr> </tbody> </table>	Code	Description	Qty	UOM	RC1200A0	MOLLA A COMPRESSIO NE De4 D10.5 H24	2.000	PZ	V11220A1	VITE AUTOFIL. 4.2X11 TCS+ MARUTEX	1.000	PZ	V11996A0	VITE M5x35 TCEI ZN	7.000	PZ	VM2259A1	TAPPO INF SX PORTA S6	1.000	PZ	VM2261A1	TAPPO INF DX PORTA MM	1.000	PZ	VM2267A1	CORSOIO SISTEMA FERMA VETRO INT	1.000	PZ	VM2269A0	TAPPO SISTEMA FERMA VETRO INT	1.000	PZ	VM2274A0	BOCCOLA SCANALATA CORTA	1.000	PZ	VM2305A0	NOTTOLINO FISSAGGIO TAPPI PORTE MM	7.000	PZ	K0B1122AL	CHEFTOP MM LEFT DOOR LOWER BEAM KIT	<table border="1"> <thead> <tr> <th>Code</th> <th>Description</th> <th>Qty</th> <th>UOM</th> </tr> </thead> <tbody> <tr> <td>0B1122A1</td> <td>TRAVERSO INFERIORE PORTA 750 S6</td> <td>1.000</td> <td>PZ</td> </tr> <tr> <td>RC1200A0</td> <td>MOLLA A COMPRESSIO NE De4 D10.5 H24</td> <td>2.000</td> <td>PZ</td> </tr> <tr> <td>V11220A1</td> <td>VITE AUTOFIL. 4.2X11 TCS+ MARUTEX</td> <td>1.000</td> <td>PZ</td> </tr> <tr> <td>V11996A0</td> <td>VITE M5x35 TCEI ZN</td> <td>7.000</td> <td>PZ</td> </tr> <tr> <td>VM1794A0</td> <td>FASCETTA 430X4.8 PA66 NERA</td> <td>2.000</td> <td>PZ</td> </tr> <tr> <td>VM2267A1</td> <td>CORSOIO SISTEMA FERMA VETRO INT</td> <td>1.000</td> <td>PZ</td> </tr> <tr> <td>VM2269A0</td> <td>TAPPO SISTEMA FERMA VETRO INT</td> <td>1.000</td> <td>PZ</td> </tr> </tbody> </table>	Code	Description	Qty	UOM	0B1122A1	TRAVERSO INFERIORE PORTA 750 S6	1.000	PZ	RC1200A0	MOLLA A COMPRESSIO NE De4 D10.5 H24	2.000	PZ	V11220A1	VITE AUTOFIL. 4.2X11 TCS+ MARUTEX	1.000	PZ	V11996A0	VITE M5x35 TCEI ZN	7.000	PZ	VM1794A0	FASCETTA 430X4.8 PA66 NERA	2.000	PZ	VM2267A1	CORSOIO SISTEMA FERMA VETRO INT	1.000	PZ	VM2269A0	TAPPO SISTEMA FERMA VETRO INT	1.000	PZ
			Code	Description	Qty	UOM																																																																										
RC1200A0	MOLLA A COMPRESSIO NE De4 D10.5 H24	2.000	PZ																																																																													
V11220A1	VITE AUTOFIL. 4.2X11 TCS+ MARUTEX	1.000	PZ																																																																													
V11996A0	VITE M5x35 TCEI ZN	7.000	PZ																																																																													
VM2259A1	TAPPO INF SX PORTA S6	1.000	PZ																																																																													
VM2261A1	TAPPO INF DX PORTA MM	1.000	PZ																																																																													
VM2267A1	CORSOIO SISTEMA FERMA VETRO INT	1.000	PZ																																																																													
VM2269A0	TAPPO SISTEMA FERMA VETRO INT	1.000	PZ																																																																													
VM2274A0	BOCCOLA SCANALATA CORTA	1.000	PZ																																																																													
VM2305A0	NOTTOLINO FISSAGGIO TAPPI PORTE MM	7.000	PZ																																																																													
Code	Description	Qty	UOM																																																																													
0B1122A1	TRAVERSO INFERIORE PORTA 750 S6	1.000	PZ																																																																													
RC1200A0	MOLLA A COMPRESSIO NE De4 D10.5 H24	2.000	PZ																																																																													
V11220A1	VITE AUTOFIL. 4.2X11 TCS+ MARUTEX	1.000	PZ																																																																													
V11996A0	VITE M5x35 TCEI ZN	7.000	PZ																																																																													
VM1794A0	FASCETTA 430X4.8 PA66 NERA	2.000	PZ																																																																													
VM2267A1	CORSOIO SISTEMA FERMA VETRO INT	1.000	PZ																																																																													
VM2269A0	TAPPO SISTEMA FERMA VETRO INT	1.000	PZ																																																																													

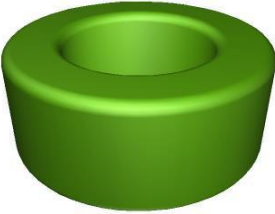

COMPONENT			SPARE PART																																		
Code	Description	Image	Code	Description	Kit components																																
VM2274A	BOCCOLA SCANALATA CORTA		K0B1122AL	CHEFTOP MM LEFT DOOR LOWER BEAM KIT	<table border="1"> <thead> <tr> <th>Code</th> <th>Description</th> <th>Qty</th> <th>UOM</th> </tr> </thead> <tbody> <tr> <td>VM2274A0</td> <td>BOCCOLA SCANALATA CORTA</td> <td>1.000</td> <td>PZ</td> </tr> <tr> <td>VM2305A0</td> <td>NOTTOLINO FISSAGGIO TAPPI PORTE MM</td> <td>7.000</td> <td>PZ</td> </tr> <tr> <td>VM2384A0</td> <td>TAPPO INF DX PORTA MM LEFT</td> <td>1.000</td> <td>PZ</td> </tr> <tr> <td>VM2386A1</td> <td>TAPPO INF SX PORTA MM LEFT</td> <td>1.000</td> <td>PZ</td> </tr> </tbody> </table>	Code	Description	Qty	UOM	VM2274A0	BOCCOLA SCANALATA CORTA	1.000	PZ	VM2305A0	NOTTOLINO FISSAGGIO TAPPI PORTE MM	7.000	PZ	VM2384A0	TAPPO INF DX PORTA MM LEFT	1.000	PZ	VM2386A1	TAPPO INF SX PORTA MM LEFT	1.000	PZ												
Code	Description	Qty	UOM																																		
VM2274A0	BOCCOLA SCANALATA CORTA	1.000	PZ																																		
VM2305A0	NOTTOLINO FISSAGGIO TAPPI PORTE MM	7.000	PZ																																		
VM2384A0	TAPPO INF DX PORTA MM LEFT	1.000	PZ																																		
VM2386A1	TAPPO INF SX PORTA MM LEFT	1.000	PZ																																		
VM2305A	NOTTOLINO FISSAGGIO TAPPI PORTE MM		KVM2305A	MM FIXING DOOR THUB SCREWS 10 PCS KIT	<table border="1"> <thead> <tr> <th>Code</th> <th>Description</th> <th>Qty</th> <th>UOM</th> </tr> </thead> <tbody> <tr> <td>VM2305A0</td> <td>NOTTOLINO FISSAGGIO TAPPI PORTE MM</td> <td>10.000</td> <td>PZ</td> </tr> </tbody> </table>	Code	Description	Qty	UOM	VM2305A0	NOTTOLINO FISSAGGIO TAPPI PORTE MM	10.000	PZ																								
Code	Description	Qty	UOM																																		
VM2305A0	NOTTOLINO FISSAGGIO TAPPI PORTE MM	10.000	PZ																																		
VP1080A	TAPPO SUP CERNIERA VETRO INTERNO INF		KVM2259B	MM -M RIGHT DOOR LEFT LOWER CAP KI	<table border="1"> <thead> <tr> <th>Code</th> <th>Description</th> <th>Qty</th> <th>UOM</th> </tr> </thead> <tbody> <tr> <td>V1103A0</td> <td>VITE PER PLASTICA 4X12 TPBS+ ZN-NI</td> <td>1.000</td> <td>PZ</td> </tr> <tr> <td>V11930A1</td> <td>VITE 5X20 TRUCIOLARE INOX</td> <td>4.000</td> <td>PZ</td> </tr> <tr> <td>V11996A0</td> <td>VITE M5x35 TCEI ZN</td> <td>3.000</td> <td>PZ</td> </tr> <tr> <td>VM2259B0</td> <td>TAPPO INF SX PORTA S6</td> <td>1.000</td> <td>PZ</td> </tr> <tr> <td>VM2274A0</td> <td>BOCCOLA SCANALATA CORTA</td> <td>1.000</td> <td>PZ</td> </tr> <tr> <td>VM2305A0</td> <td>NOTTOLINO FISSAGGIO TAPPI PORTE MM</td> <td>3.000</td> <td>PZ</td> </tr> <tr> <td>VP1080A0</td> <td>TAPPO SUP CERNIERA VETRO INTERNO INF</td> <td>1.000</td> <td>PZ</td> </tr> </tbody> </table>	Code	Description	Qty	UOM	V1103A0	VITE PER PLASTICA 4X12 TPBS+ ZN-NI	1.000	PZ	V11930A1	VITE 5X20 TRUCIOLARE INOX	4.000	PZ	V11996A0	VITE M5x35 TCEI ZN	3.000	PZ	VM2259B0	TAPPO INF SX PORTA S6	1.000	PZ	VM2274A0	BOCCOLA SCANALATA CORTA	1.000	PZ	VM2305A0	NOTTOLINO FISSAGGIO TAPPI PORTE MM	3.000	PZ	VP1080A0	TAPPO SUP CERNIERA VETRO INTERNO INF	1.000	PZ
Code	Description	Qty	UOM																																		
V1103A0	VITE PER PLASTICA 4X12 TPBS+ ZN-NI	1.000	PZ																																		
V11930A1	VITE 5X20 TRUCIOLARE INOX	4.000	PZ																																		
V11996A0	VITE M5x35 TCEI ZN	3.000	PZ																																		
VM2259B0	TAPPO INF SX PORTA S6	1.000	PZ																																		
VM2274A0	BOCCOLA SCANALATA CORTA	1.000	PZ																																		
VM2305A0	NOTTOLINO FISSAGGIO TAPPI PORTE MM	3.000	PZ																																		
VP1080A0	TAPPO SUP CERNIERA VETRO INTERNO INF	1.000	PZ																																		



COMPONENT			SPARE PART																		
Code	Description	Image	Code	Description	Kit components																
VM2284B	PROFILO SALVAGOCCE SERIE 750		KVM2284B	750 -M SERIES DRIP PROFILE KIT	<table border="1"> <thead> <tr> <th>Code</th> <th>Description</th> <th>Qty</th> <th>UOM</th> </tr> </thead> <tbody> <tr> <td>VM2284B0</td> <td>PROFILO SALVAGOCCE SERIE 750</td> <td>1.000</td> <td>PZ</td> </tr> </tbody> </table>	Code	Description	Qty	UOM	VM2284B0	PROFILO SALVAGOCCE SERIE 750	1.000	PZ								
Code	Description	Qty	UOM																		
VM2284B0	PROFILO SALVAGOCCE SERIE 750	1.000	PZ																		
VM2312A	TUBETTO SX SCARICO GOCCIOLATOIO MM		KVM2312A	M.M. DRIP TRAY LEFT DRAIN PIPE KI	<table border="1"> <thead> <tr> <th>Code</th> <th>Description</th> <th>Qty</th> <th>UOM</th> </tr> </thead> <tbody> <tr> <td>VI1220A1</td> <td>VITE AUTOFIL. 4.2X11 TCS+ MARUTEX</td> <td>1.000</td> <td>PZ</td> </tr> <tr> <td>VM2312A0</td> <td>TUBETTO SX SCARICO GOCCIOLATOIO MM</td> <td>1.000</td> <td>PZ</td> </tr> </tbody> </table>	Code	Description	Qty	UOM	VI1220A1	VITE AUTOFIL. 4.2X11 TCS+ MARUTEX	1.000	PZ	VM2312A0	TUBETTO SX SCARICO GOCCIOLATOIO MM	1.000	PZ				
Code	Description	Qty	UOM																		
VI1220A1	VITE AUTOFIL. 4.2X11 TCS+ MARUTEX	1.000	PZ																		
VM2312A0	TUBETTO SX SCARICO GOCCIOLATOIO MM	1.000	PZ																		
VM2314A	TAPPINO GOCCIOLATOIO MM		KVM2314A	MIND.Maps DRIP TRAY CAP	<table border="1"> <thead> <tr> <th>Code</th> <th>Description</th> <th>Qty</th> <th>UOM</th> </tr> </thead> <tbody> <tr> <td>GN1525A0</td> <td>O-RING D.INT 9.5xSP 1 NBR 7</td> <td>1.000</td> <td>PZ</td> </tr> <tr> <td>VI1103A0</td> <td>VITE PER PLASTICA 4X12 TPBS+ ZN-NI</td> <td>1.000</td> <td>PZ</td> </tr> <tr> <td>VM2314A0</td> <td>TAPPINO GOCCIOLATOIO MM</td> <td>1.000</td> <td>PZ</td> </tr> </tbody> </table>	Code	Description	Qty	UOM	GN1525A0	O-RING D.INT 9.5xSP 1 NBR 7	1.000	PZ	VI1103A0	VITE PER PLASTICA 4X12 TPBS+ ZN-NI	1.000	PZ	VM2314A0	TAPPINO GOCCIOLATOIO MM	1.000	PZ
Code	Description	Qty	UOM																		
GN1525A0	O-RING D.INT 9.5xSP 1 NBR 7	1.000	PZ																		
VI1103A0	VITE PER PLASTICA 4X12 TPBS+ ZN-NI	1.000	PZ																		
VM2314A0	TAPPINO GOCCIOLATOIO MM	1.000	PZ																		
VM1631A	TAPPO PREMI VETRO INTERNO PLUS		KVM1631A	CAP FOR INTERNAL GLASS 10 PCS KIT	<table border="1"> <thead> <tr> <th>Code</th> <th>Description</th> <th>Qty</th> <th>UOM</th> </tr> </thead> <tbody> <tr> <td>VM1631A0</td> <td>TAPPO PREMI VETRO INTERNO PLU</td> <td>10.000</td> <td>PZ</td> </tr> </tbody> </table>	Code	Description	Qty	UOM	VM1631A0	TAPPO PREMI VETRO INTERNO PLU	10.000	PZ								
Code	Description	Qty	UOM																		
VM1631A0	TAPPO PREMI VETRO INTERNO PLU	10.000	PZ																		
VM2505B	SUPPORTO PREMI VETRO INT MM PLU		KVM2505B	MM-M DOUBLE INNER GLASS PUSHING 3PCS KIT	<table border="1"> <thead> <tr> <th>Code</th> <th>Description</th> <th>Qty</th> <th>UOM</th> </tr> </thead> <tbody> <tr> <td>VI1220A1</td> <td>VITE AUTOFIL. 4.2X11 TCS+ MARUTEX</td> <td>3.000</td> <td>PZ</td> </tr> <tr> <td>VM1631A0</td> <td>TAPPO PREMI VETRO INTERNO PLU</td> <td>3.000</td> <td>PZ</td> </tr> <tr> <td>VM2505B1</td> <td>SUPPORTO PREMI VETRO INT MM PLUS</td> <td>3.000</td> <td>PZ</td> </tr> </tbody> </table>	Code	Description	Qty	UOM	VI1220A1	VITE AUTOFIL. 4.2X11 TCS+ MARUTEX	3.000	PZ	VM1631A0	TAPPO PREMI VETRO INTERNO PLU	3.000	PZ	VM2505B1	SUPPORTO PREMI VETRO INT MM PLUS	3.000	PZ
Code	Description	Qty	UOM																		
VI1220A1	VITE AUTOFIL. 4.2X11 TCS+ MARUTEX	3.000	PZ																		
VM1631A0	TAPPO PREMI VETRO INTERNO PLU	3.000	PZ																		
VM2505B1	SUPPORTO PREMI VETRO INT MM PLUS	3.000	PZ																		

COMPONENT			SPARE PART																														
Code	Description	Image	Code	Description	Kit components																												
CR1105A	CERNIERA VETRO INTERNO DOPPIO INOX SUP		KCR1105A	MIND.Maps PLUS INTERNAL GLASS HINGES KIT	<table border="1"> <thead> <tr> <th>Code</th> <th>Description</th> <th>Qty</th> <th>UOM</th> </tr> </thead> <tbody> <tr> <td>CR1105A0</td> <td>CERNIERA VETRO INTERNO DOPPIO INOX SUP</td> <td>1.000</td> <td>PZ</td> </tr> <tr> <td>CR1106A0</td> <td>CERNIERA VETRO INTERNO DOPPIO INOX INF</td> <td>1.000</td> <td>PZ</td> </tr> <tr> <td>VI1220A1</td> <td>VITE AUTOFIL. 4.2X11 TCS+ MARUTEX</td> <td>4.000</td> <td>PZ</td> </tr> </tbody> </table>	Code	Description	Qty	UOM	CR1105A0	CERNIERA VETRO INTERNO DOPPIO INOX SUP	1.000	PZ	CR1106A0	CERNIERA VETRO INTERNO DOPPIO INOX INF	1.000	PZ	VI1220A1	VITE AUTOFIL. 4.2X11 TCS+ MARUTEX	4.000	PZ												
					Code	Description	Qty	UOM																									
					CR1105A0	CERNIERA VETRO INTERNO DOPPIO INOX SUP	1.000	PZ																									
CR1106A0	CERNIERA VETRO INTERNO DOPPIO INOX INF	1.000	PZ																														
VI1220A1	VITE AUTOFIL. 4.2X11 TCS+ MARUTEX	4.000	PZ																														
CR1106A0	CERNIERA VETRO INTERNO DOPPIO INOX INF	1.000	PZ																														
VI1220A1	VITE AUTOFIL. 4.2X11 TCS+ MARUTEX	4.000	PZ																														
CR1106A	CERNIERA VETRO INTERNO DOPPIO INOX INF		KCR1105A	MIND.Maps PLUS INTERNAL GLASS HINGES KIT	<table border="1"> <thead> <tr> <th>Code</th> <th>Description</th> <th>Qty</th> <th>UOM</th> </tr> </thead> <tbody> <tr> <td>CR1105A0</td> <td>CERNIERA VETRO INTERNO DOPPIO INOX SUP</td> <td>1.000</td> <td>PZ</td> </tr> <tr> <td>CR1106A0</td> <td>CERNIERA VETRO INTERNO DOPPIO INOX INF</td> <td>1.000</td> <td>PZ</td> </tr> <tr> <td>VI1220A1</td> <td>VITE AUTOFIL. 4.2X11 TCS+ MARUTEX</td> <td>4.000</td> <td>PZ</td> </tr> </tbody> </table>	Code	Description	Qty	UOM	CR1105A0	CERNIERA VETRO INTERNO DOPPIO INOX SUP	1.000	PZ	CR1106A0	CERNIERA VETRO INTERNO DOPPIO INOX INF	1.000	PZ	VI1220A1	VITE AUTOFIL. 4.2X11 TCS+ MARUTEX	4.000	PZ												
					Code	Description	Qty	UOM																									
					CR1105A0	CERNIERA VETRO INTERNO DOPPIO INOX SUP	1.000	PZ																									
CR1106A0	CERNIERA VETRO INTERNO DOPPIO INOX INF	1.000	PZ																														
VI1220A1	VITE AUTOFIL. 4.2X11 TCS+ MARUTEX	4.000	PZ																														
CR1106A0	CERNIERA VETRO INTERNO DOPPIO INOX INF	1.000	PZ																														
VI1220A1	VITE AUTOFIL. 4.2X11 TCS+ MARUTEX	4.000	PZ																														
VT1284C	VETRO INT. SER. 0511 639X454X4 2V		KVT1284C	0511 INNER DOUBLE GLASS KIT	<table border="1"> <thead> <tr> <th>Code</th> <th>Description</th> <th>Qty</th> <th>UOM</th> </tr> </thead> <tbody> <tr> <td>0B1180A0</td> <td>PROFILO INT SUP-INF VETRO DOPPIO GN1-1</td> <td>2.000</td> <td>PZ</td> </tr> <tr> <td>0B1181A0</td> <td>PROFILO INT SX DX VETRO DOPPIO 0511</td> <td>2.000</td> <td>PZ</td> </tr> <tr> <td>0B1210A1</td> <td>PROFILO EST SUP-INF VETRO 2V GN1-1</td> <td>2.000</td> <td>PZ</td> </tr> <tr> <td>0B1212A3</td> <td>PROFILO EST SX-DX VETRO 2V 0511</td> <td>2.000</td> <td>PZ</td> </tr> <tr> <td>CR1105A0</td> <td>CERNIERA VETRO INTERNO DOPPIO INOX SUP</td> <td>1.000</td> <td>PZ</td> </tr> <tr> <td>CR1106A0</td> <td>CERNIERA VETRO INTERNO DOPPIO INOX INF</td> <td>1.000</td> <td>PZ</td> </tr> </tbody> </table>	Code	Description	Qty	UOM	0B1180A0	PROFILO INT SUP-INF VETRO DOPPIO GN1-1	2.000	PZ	0B1181A0	PROFILO INT SX DX VETRO DOPPIO 0511	2.000	PZ	0B1210A1	PROFILO EST SUP-INF VETRO 2V GN1-1	2.000	PZ	0B1212A3	PROFILO EST SX-DX VETRO 2V 0511	2.000	PZ	CR1105A0	CERNIERA VETRO INTERNO DOPPIO INOX SUP	1.000	PZ	CR1106A0	CERNIERA VETRO INTERNO DOPPIO INOX INF	1.000	PZ
					Code	Description	Qty	UOM																									
					0B1180A0	PROFILO INT SUP-INF VETRO DOPPIO GN1-1	2.000	PZ																									
					0B1181A0	PROFILO INT SX DX VETRO DOPPIO 0511	2.000	PZ																									
					0B1210A1	PROFILO EST SUP-INF VETRO 2V GN1-1	2.000	PZ																									
					0B1212A3	PROFILO EST SX-DX VETRO 2V 0511	2.000	PZ																									
					CR1105A0	CERNIERA VETRO INTERNO DOPPIO INOX SUP	1.000	PZ																									
					CR1106A0	CERNIERA VETRO INTERNO DOPPIO INOX INF	1.000	PZ																									
0B1180A0	PROFILO INT SUP-INF VETRO DOPPIO GN1-1	2.000	PZ																														
0B1181A0	PROFILO INT SX DX VETRO DOPPIO 0511	2.000	PZ																														
0B1210A1	PROFILO EST SUP-INF VETRO 2V GN1-1	2.000	PZ																														
0B1212A3	PROFILO EST SX-DX VETRO 2V 0511	2.000	PZ																														
CR1105A0	CERNIERA VETRO INTERNO DOPPIO INOX SUP	1.000	PZ																														
CR1106A0	CERNIERA VETRO INTERNO DOPPIO INOX INF	1.000	PZ																														

COMPONENT			SPARE PART																		
Code	Description	Image	Code	Description	Kit components																
VT1284C	VETRO INT. SER. 0511 639X454X4 2V		KVT1284C	0511 INNER DOUBLE GLASS KIT	<table border="1"> <thead> <tr> <th>Code</th> <th>Description</th> <th>Qty</th> <th>UOM</th> </tr> </thead> <tbody> <tr> <td>VI1220A1</td> <td>VITE AUTOFIL. 4.2X11 TCS+ MARUTEX</td> <td>4.000</td> <td>PZ</td> </tr> <tr> <td>VI1225A0</td> <td>RIVETTO STRUTT. 4X8 INOX</td> <td>20.000</td> <td>PZ</td> </tr> <tr> <td>VT1284C0</td> <td>VETRO INT. SER. 0511 639X454X4 2V</td> <td>2.000</td> <td>PZ</td> </tr> </tbody> </table>	Code	Description	Qty	UOM	VI1220A1	VITE AUTOFIL. 4.2X11 TCS+ MARUTEX	4.000	PZ	VI1225A0	RIVETTO STRUTT. 4X8 INOX	20.000	PZ	VT1284C0	VETRO INT. SER. 0511 639X454X4 2V	2.000	PZ
Code	Description	Qty	UOM																		
VI1220A1	VITE AUTOFIL. 4.2X11 TCS+ MARUTEX	4.000	PZ																		
VI1225A0	RIVETTO STRUTT. 4X8 INOX	20.000	PZ																		
VT1284C0	VETRO INT. SER. 0511 639X454X4 2V	2.000	PZ																		
VM2518A	SUPPORTO VENTOLA RAFF CRUS 20X20 H20		KVM2518A	PANEL COOLING FAN SUPPORT KIT	<table border="1"> <thead> <tr> <th>Code</th> <th>Description</th> <th>Qty</th> <th>UOM</th> </tr> </thead> <tbody> <tr> <td>VM2518A0</td> <td>SUPPORTO VENTOLA RAFF CRUS 20X20 H20</td> <td>1.000</td> <td>PZ</td> </tr> </tbody> </table>	Code	Description	Qty	UOM	VM2518A0	SUPPORTO VENTOLA RAFF CRUS 20X20 H20	1.000	PZ								
Code	Description	Qty	UOM																		
VM2518A0	SUPPORTO VENTOLA RAFF CRUS 20X20 H20	1.000	PZ																		
VN1179A	VENTIL ASSIALE 40x40x20mm 12Vcc		KVN1179A	CONTROL BOARD COOLING FAN KIT	<table border="1"> <thead> <tr> <th>Code</th> <th>Description</th> <th>Qty</th> <th>UOM</th> </tr> </thead> <tbody> <tr> <td>VN1179A1</td> <td>VENTIL ASSIALE 40x40x20mm 12Vcc</td> <td>1.000</td> <td>PZ</td> </tr> </tbody> </table>	Code	Description	Qty	UOM	VN1179A1	VENTIL ASSIALE 40x40x20mm 12Vcc	1.000	PZ								
Code	Description	Qty	UOM																		
VN1179A1	VENTIL ASSIALE 40x40x20mm 12Vcc	1.000	PZ																		
CE1096A	CAVO BUS MICROFIT 4POLI 3 M		KCE1096A	3 M POWER-CONTROL 4 POLES BUS CABLE KIT	<table border="1"> <thead> <tr> <th>Code</th> <th>Description</th> <th>Qty</th> <th>UOM</th> </tr> </thead> <tbody> <tr> <td>CE1096A0</td> <td>CAVO BUS MICROFIT 4POLI 3 M</td> <td>1.000</td> <td>PZ</td> </tr> </tbody> </table>	Code	Description	Qty	UOM	CE1096A0	CAVO BUS MICROFIT 4POLI 3 M	1.000	PZ								
Code	Description	Qty	UOM																		
CE1096A0	CAVO BUS MICROFIT 4POLI 3 M	1.000	PZ																		
CE1285A	FERRITE EMI ROUND MOD. 2643801502		KCE1285A	ROUND FERRITE ELECTROMAGN PROT. 2PCS KIT	<table border="1"> <thead> <tr> <th>Code</th> <th>Description</th> <th>Qty</th> <th>UOM</th> </tr> </thead> <tbody> <tr> <td>CE1285A0</td> <td>FERRITE EMI ROUND MOD. 2643801502</td> <td>2.000</td> <td>PZ</td> </tr> </tbody> </table>	Code	Description	Qty	UOM	CE1285A0	FERRITE EMI ROUND MOD. 2643801502	2.000	PZ								
Code	Description	Qty	UOM																		
CE1285A0	FERRITE EMI ROUND MOD. 2643801502	2.000	PZ																		

COMPONENT			SPARE PART																		
Code	Description	Image	Code	Description	Kit components																
VI1074A	VITE PER PLASTICA 4X16 TPBS+ INOX		VI1074A0	VITE PER PLASTICA 4X16 TPBS+ INOX																	
MG1091B	ASSIEME MANIGLIA COMPLETO MM ENERGY STAR		KMG1091B	MM ENERGY STAR HANDLE KIT -M	<table border="1"> <thead> <tr> <th>Code</th> <th>Description</th> <th>Qty</th> <th>UOM</th> </tr> </thead> <tbody> <tr> <td>MG1091B1</td> <td>ASSIEME MANIGLIA COMPLETO MM ENERGY STAR</td> <td>1.000</td> <td>PZ</td> </tr> <tr> <td>VI1074A0</td> <td>VITE PER PLASTICA 4X16 TPBS+ INOX</td> <td>4.000</td> <td>PZ</td> </tr> <tr> <td>VM1490A0</td> <td>COPRI VITI MANIGLIA CHEFTOP BAKERTOP</td> <td>2.000</td> <td>PZ</td> </tr> </tbody> </table>	Code	Description	Qty	UOM	MG1091B1	ASSIEME MANIGLIA COMPLETO MM ENERGY STAR	1.000	PZ	VI1074A0	VITE PER PLASTICA 4X16 TPBS+ INOX	4.000	PZ	VM1490A0	COPRI VITI MANIGLIA CHEFTOP BAKERTOP	2.000	PZ
Code	Description	Qty	UOM																		
MG1091B1	ASSIEME MANIGLIA COMPLETO MM ENERGY STAR	1.000	PZ																		
VI1074A0	VITE PER PLASTICA 4X16 TPBS+ INOX	4.000	PZ																		
VM1490A0	COPRI VITI MANIGLIA CHEFTOP BAKERTOP	2.000	PZ																		
CE1052A	CAVO CONNESSIONE CONTROLLO-USB MM 750mm		KCE1052A	CONTROL BOARD-USB 650 CONN. CABLE KIT	<table border="1"> <thead> <tr> <th>Code</th> <th>Description</th> <th>Qty</th> <th>UOM</th> </tr> </thead> <tbody> <tr> <td>CE1052A1</td> <td>CAVO CONNESSION E CONTROLLO- USB MM 750m</td> <td>1.000</td> <td>PZ</td> </tr> </tbody> </table>	Code	Description	Qty	UOM	CE1052A1	CAVO CONNESSION E CONTROLLO- USB MM 750m	1.000	PZ								
Code	Description	Qty	UOM																		
CE1052A1	CAVO CONNESSION E CONTROLLO- USB MM 750m	1.000	PZ																		
CE1053B	CAVO ALIMENT BARRA LED MM MICROFIT 2P		KCE1053B	LED BAR EXTENSION CABLE KIT	<table border="1"> <thead> <tr> <th>Code</th> <th>Description</th> <th>Qty</th> <th>UOM</th> </tr> </thead> <tbody> <tr> <td>CE1053B0</td> <td>CAVO ALIMENT BARRA LED MM MICROFIT 2P</td> <td>1.000</td> <td>PZ</td> </tr> </tbody> </table>	Code	Description	Qty	UOM	CE1053B0	CAVO ALIMENT BARRA LED MM MICROFIT 2P	1.000	PZ								
Code	Description	Qty	UOM																		
CE1053B0	CAVO ALIMENT BARRA LED MM MICROFIT 2P	1.000	PZ																		
LP1019A	BARRA ILLUMINAZIONE LED MM L200 E415		KLP1019A	L200 E415 LED LIGHT BAR KIT	<table border="1"> <thead> <tr> <th>Code</th> <th>Description</th> <th>Qty</th> <th>UOM</th> </tr> </thead> <tbody> <tr> <td>LP1019A0</td> <td>BARRA ILLUMINAZION E LED MM L200 E415</td> <td>1.000</td> <td>PZ</td> </tr> </tbody> </table>	Code	Description	Qty	UOM	LP1019A0	BARRA ILLUMINAZION E LED MM L200 E415	1.000	PZ								
Code	Description	Qty	UOM																		
LP1019A0	BARRA ILLUMINAZION E LED MM L200 E415	1.000	PZ																		

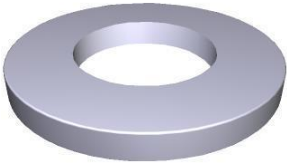
COMPONENT			SPARE PART																																		
Code	Description	Image	Code	Description	Kit components																																
LP1025A	ESTRUSO ILLUMINAZIONE NO LED MM L415		KLP1025A	L415 MM NO LED LIGHT HOLDER KIT	<table border="1"> <thead> <tr> <th>Code</th> <th>Description</th> <th>Qty</th> <th>UOM</th> </tr> </thead> <tbody> <tr> <td>LP1025A0</td> <td>ESTRUSO ILLUMINAZIONE NO LED MM L415</td> <td>1.000</td> <td>PZ</td> </tr> </tbody> </table>	Code	Description	Qty	UOM	LP1025A0	ESTRUSO ILLUMINAZIONE NO LED MM L415	1.000	PZ																								
Code	Description	Qty	UOM																																		
LP1025A0	ESTRUSO ILLUMINAZIONE NO LED MM L415	1.000	PZ																																		
PE1057B	CRUSCOTTO COMPLETO CAP MM PLUS		KPE1057B	MM PLUS CAPACITIVE CONTROL BOARD KIT	<table border="1"> <thead> <tr> <th>Code</th> <th>Description</th> <th>Qty</th> <th>UOM</th> </tr> </thead> <tbody> <tr> <td>CE2007A0</td> <td>CAVO MICROFIT 4PM-MINIFIT 4PF 100mm</td> <td>1.000</td> <td>PZ</td> </tr> <tr> <td>PE1057B0</td> <td>CRUSCOTTO COMPLETO CAP MM PLUS</td> <td>1.000</td> <td>PZ</td> </tr> <tr> <td>VI1074A0</td> <td>VITE PER PLASTICA 4X16 TPBS+ INOX</td> <td>2.000</td> <td>PZ</td> </tr> <tr> <td>VM1447A0</td> <td>BUSTA AIRBALL ESD ROSA 230X450 MM</td> <td>1.000</td> <td>PZ</td> </tr> <tr> <td>VM2295A1</td> <td>PENNINO CONTROLLO MM</td> <td>1.000</td> <td>PZ</td> </tr> <tr> <td>VP1067A0</td> <td>DISTANZIALE RETROFIT PER CONTROLLO MM</td> <td>1.000</td> <td>PZ</td> </tr> <tr> <td>VP1078A0</td> <td>CORNICE RETROFIT PER CONTROLLO MM</td> <td>1.000</td> <td>PZ</td> </tr> </tbody> </table>	Code	Description	Qty	UOM	CE2007A0	CAVO MICROFIT 4PM-MINIFIT 4PF 100mm	1.000	PZ	PE1057B0	CRUSCOTTO COMPLETO CAP MM PLUS	1.000	PZ	VI1074A0	VITE PER PLASTICA 4X16 TPBS+ INOX	2.000	PZ	VM1447A0	BUSTA AIRBALL ESD ROSA 230X450 MM	1.000	PZ	VM2295A1	PENNINO CONTROLLO MM	1.000	PZ	VP1067A0	DISTANZIALE RETROFIT PER CONTROLLO MM	1.000	PZ	VP1078A0	CORNICE RETROFIT PER CONTROLLO MM	1.000	PZ
Code	Description	Qty	UOM																																		
CE2007A0	CAVO MICROFIT 4PM-MINIFIT 4PF 100mm	1.000	PZ																																		
PE1057B0	CRUSCOTTO COMPLETO CAP MM PLUS	1.000	PZ																																		
VI1074A0	VITE PER PLASTICA 4X16 TPBS+ INOX	2.000	PZ																																		
VM1447A0	BUSTA AIRBALL ESD ROSA 230X450 MM	1.000	PZ																																		
VM2295A1	PENNINO CONTROLLO MM	1.000	PZ																																		
VP1067A0	DISTANZIALE RETROFIT PER CONTROLLO MM	1.000	PZ																																		
VP1078A0	CORNICE RETROFIT PER CONTROLLO MM	1.000	PZ																																		
PE1059A	ASM SUPPORTO USB-RESET MM		KPE1059A	MM USB-RESET SUPPORT KIT	<table border="1"> <thead> <tr> <th>Code</th> <th>Description</th> <th>Qty</th> <th>UOM</th> </tr> </thead> <tbody> <tr> <td>PE1059A0</td> <td>ASM SUPPORTO USB-RESET M</td> <td>1.000</td> <td>PZ</td> </tr> <tr> <td>VI1220A1</td> <td>VITE AUTOFIL. 4.2X11 TCS+ MARUTEX</td> <td>2.000</td> <td>PZ</td> </tr> <tr> <td>VM1447A0</td> <td>BUSTA AIRBALL ESD ROSA 230X450 MM</td> <td>0.500</td> <td>PZ</td> </tr> </tbody> </table>	Code	Description	Qty	UOM	PE1059A0	ASM SUPPORTO USB-RESET M	1.000	PZ	VI1220A1	VITE AUTOFIL. 4.2X11 TCS+ MARUTEX	2.000	PZ	VM1447A0	BUSTA AIRBALL ESD ROSA 230X450 MM	0.500	PZ																
Code	Description	Qty	UOM																																		
PE1059A0	ASM SUPPORTO USB-RESET M	1.000	PZ																																		
VI1220A1	VITE AUTOFIL. 4.2X11 TCS+ MARUTEX	2.000	PZ																																		
VM1447A0	BUSTA AIRBALL ESD ROSA 230X450 MM	0.500	PZ																																		

COMPONENT			SPARE PART																																		
Code	Description	Image	Code	Description	Kit components																																
VI1034A	RONDELLA PIANA 8.4x16x1 INOX		KVI1034A	STAINLESS STEEL WASHER 10 PCS KIT	<table border="1"> <thead> <tr> <th>Code</th> <th>Description</th> <th>Qty</th> <th>UOM</th> </tr> </thead> <tbody> <tr> <td>VI1034A0</td> <td>RONDELLA PIANA 8.4x16x1 INOX</td> <td>10.000</td> <td>PZ</td> </tr> </tbody> </table>	Code	Description	Qty	UOM	VI1034A0	RONDELLA PIANA 8.4x16x1 INOX	10.000	PZ																								
Code	Description	Qty	UOM																																		
VI1034A0	RONDELLA PIANA 8.4x16x1 INOX	10.000	PZ																																		
VT1276A	VETRO ESTERNO SER. XEVC-0511-E		KVT1276A	0511 EXTERNAL GLASS KIT	<table border="1"> <thead> <tr> <th>Code</th> <th>Description</th> <th>Qty</th> <th>UOM</th> </tr> </thead> <tbody> <tr> <td>0B1166A1</td> <td>PROFILO SUPPORTO VETRO EST XEVC-0511-E</td> <td>2.000</td> <td>PZ</td> </tr> <tr> <td>SL1221A0</td> <td>SILICONE SUP VETRO EXT GN1/1</td> <td>1.000</td> <td>PZ</td> </tr> <tr> <td>SL1222A0</td> <td>SILICONE LAT VETRO EXT 0511</td> <td>4.000</td> <td>PZ</td> </tr> <tr> <td>VT1276A0</td> <td>VETRO ESTERNO SER. XEVC-0511-E</td> <td>1.000</td> <td>PZ</td> </tr> </tbody> </table>	Code	Description	Qty	UOM	0B1166A1	PROFILO SUPPORTO VETRO EST XEVC-0511-E	2.000	PZ	SL1221A0	SILICONE SUP VETRO EXT GN1/1	1.000	PZ	SL1222A0	SILICONE LAT VETRO EXT 0511	4.000	PZ	VT1276A0	VETRO ESTERNO SER. XEVC-0511-E	1.000	PZ												
Code	Description	Qty	UOM																																		
0B1166A1	PROFILO SUPPORTO VETRO EST XEVC-0511-E	2.000	PZ																																		
SL1221A0	SILICONE SUP VETRO EXT GN1/1	1.000	PZ																																		
SL1222A0	SILICONE LAT VETRO EXT 0511	4.000	PZ																																		
VT1276A0	VETRO ESTERNO SER. XEVC-0511-E	1.000	PZ																																		
			KDR1326A	0511 ZERO LEFT -M EXTERNAL DOOR	<table border="1"> <thead> <tr> <th>Code</th> <th>Description</th> <th>Qty</th> <th>UOM</th> </tr> </thead> <tbody> <tr> <td>0B1122B0</td> <td>TRAVERSO INFERIORE PORTA 750 MMc</td> <td>1.000</td> <td>PZ</td> </tr> <tr> <td>0B1166A1</td> <td>PROFILO SUPPORTO VETRO EST XEVC-0511-E</td> <td>2.000</td> <td>PZ</td> </tr> <tr> <td>0B1195B1</td> <td>COLONNINA ESTERNA SX PORTA 0511 LEFT</td> <td>1.000</td> <td>PZ</td> </tr> <tr> <td>0B1196A1</td> <td>COLONN. INT. DX PORTA 0511 LEFT</td> <td>1.000</td> <td>PZ</td> </tr> <tr> <td>0B1197A1</td> <td>COLONNINA INTERNA SX PORTA 0511 LEFT</td> <td>1.000</td> <td>PZ</td> </tr> <tr> <td>0B1206A0</td> <td>COLONNINA ESTERNA DX PORTA 0511 LEFT</td> <td>1.000</td> <td>PZ</td> </tr> <tr> <td>0B1216B0</td> <td>TRAVERSO SUPERIORE PORTA 750 2V MMc</td> <td>1.000</td> <td>PZ</td> </tr> </tbody> </table>	Code	Description	Qty	UOM	0B1122B0	TRAVERSO INFERIORE PORTA 750 MMc	1.000	PZ	0B1166A1	PROFILO SUPPORTO VETRO EST XEVC-0511-E	2.000	PZ	0B1195B1	COLONNINA ESTERNA SX PORTA 0511 LEFT	1.000	PZ	0B1196A1	COLONN. INT. DX PORTA 0511 LEFT	1.000	PZ	0B1197A1	COLONNINA INTERNA SX PORTA 0511 LEFT	1.000	PZ	0B1206A0	COLONNINA ESTERNA DX PORTA 0511 LEFT	1.000	PZ	0B1216B0	TRAVERSO SUPERIORE PORTA 750 2V MMc	1.000	PZ
Code	Description	Qty	UOM																																		
0B1122B0	TRAVERSO INFERIORE PORTA 750 MMc	1.000	PZ																																		
0B1166A1	PROFILO SUPPORTO VETRO EST XEVC-0511-E	2.000	PZ																																		
0B1195B1	COLONNINA ESTERNA SX PORTA 0511 LEFT	1.000	PZ																																		
0B1196A1	COLONN. INT. DX PORTA 0511 LEFT	1.000	PZ																																		
0B1197A1	COLONNINA INTERNA SX PORTA 0511 LEFT	1.000	PZ																																		
0B1206A0	COLONNINA ESTERNA DX PORTA 0511 LEFT	1.000	PZ																																		
0B1216B0	TRAVERSO SUPERIORE PORTA 750 2V MMc	1.000	PZ																																		

COMPONENT			SPARE PART					
Code	Description	Image	Code	Description	Kit components			
VT1276A	VETRO ESTERNO SER. XEVC-0511-E		KDR1326A	0511 ZERO LEFT -M EXTERNAL DOOR	Code	Description	Qty	UOM
					0B1217A1	TRAVERSO SUPERIORE INT PORTA 750 S6 2V	1.000	PZ
					0H2892A0	LAMIERINO TAPPO SUP BARRA LED	1.000	PZ
					0H2893A0	LAMIERINO TAPPO INF BARRA LED	1.000	PZ
					CE1096A0	CAVO BUS MICROFIT 4POLI 3 M	1.000	PZ
					CE1285A0	FERRITE EMI ROUND MOD. 2643801502	2.000	PZ
					CE1851A0	CAVO Y MICROFIT 2P M-F-F AWG22	1.000	PZ
					CE2001A0	CAVO MICROFIT 2PM-100-2PM 2AWG22	1.000	PZ
					CE2002A0	CAVO MICROFIT 2PM-100-AMP MODU2 2AWG22	1.000	PZ
					GN1525A0	O-RING D.INT 9.5xSP 1 NBR 7	1.000	PZ
					LP1019A0	BARRA ILLUMINAZIONE LED MM L200 E415	1.000	PZ
					MG1099A1	ASSIEME MANIGLIA COMPLETO MMc	1.000	PZ
					SL1170A1	SILICONE ANTRACITE S57 CARTUCCIA 310 ml	30.000	ML
					SL1221A0	SILICONE SUP VETRO EXT GN1/1	1.000	PZ
					SL1222A0	SILICONE LAT VETRO EXT 0511	4.000	PZ
					VE1030A1	CALAMITA D=22,9mm PER MICROPORTA	1.000	PZ
					VI1034A0	RONDELLA PIANA 8.4x16x1 INOX	1.000	PZ





COMPONENT			SPARE PART					
Code	Description	Image	Code	Description	Kit components			
VT1276A	VETRO ESTERNO SER. XEVC-0511-E		KDR1326A	0511 ZERO LEFT -M EXTERNAL DOOR	Code	Description	Qty	UOM
					VI1074A0	VITE PER PLASTICA 4X16 TPBS+ INOX	1.000	PZ
					VI1174A0	VITE 5X20 PER PLASTICA ZN-NI	16.000	PZ
					VI1220A1	VITE AUTOFIL 4.2X11 TCS+ MARUTEX	26.000	PZ
					VI1996A0	VITE M5x35 TCEI ZN	13.000	PZ
					VM1490A0	COPRI VITI MANIGLIA CHEFTOP BAKERTOP	2.000	PZ
					VM1630A1	TAPPO PREMI VETRO INTERNO	3.000	PZ
					VM1631A0	TAPPO PREMI VETRO INTERNO PLU	3.000	PZ
					VM2268A0	TAPPO COPRI CALAMITA PORTA	1.000	PZ
					VM2274A0	BOCCOLA SCANALATA CORTA	1.000	PZ
					VM2275A0	BOCCOLA LISCIA CORTA	1.000	PZ
					VM2284B0	PROFILO SALVAGOCCE SERIE 750	1.000	PZ
					VM2305A0	NOTTOLINO FISSAGGIO TAPPI PORTE MM	14.000	PZ
					VM2313A0	TUBETTO DX SCARICO GOCCIOLATOI O MM	1.000	PZ
					VM2314A0	TAPPINO GOCCIOLATOI O MM	1.000	PZ
					VM2315B0	SUPPORTO SPINGI VETRO INT MM -M	3.000	PZ
					VM2384B0	TAPPO INF DX PORTA MM LEFT	1.000	PZ
					VM2505B1	SUPPORTO PREMI VETRO INT MM PLUS	3.000	PZ

COMPONENT			SPARE PART																																			
Code	Description	Image	Code	Description	Kit components																																	
VT1276A	VETRO ESTERNO SER. XEVC-0511-E		KDR1326A	0511 ZERO LEFT -M EXTERNAL DOOR	<table border="1"> <thead> <tr> <th>Code</th> <th>Description</th> <th>Qty</th> <th>UOM</th> </tr> </thead> <tbody> <tr> <td>VM2959A0</td> <td>ASSEMBLATO TAPPO SUP SX PORTA MM LEFT</td> <td>1.000</td> <td>PZ</td> </tr> <tr> <td>VM2960A0</td> <td>ASSEMBLATO TAPPO INF SX PORTA S6 LEF</td> <td>1.000</td> <td>PZ</td> </tr> <tr> <td>VM2961A0</td> <td>ASSEMBLATO TAPPO SUP DX PORTA MM LEFT</td> <td>1.000</td> <td>PZ</td> </tr> <tr> <td>VP1081A0</td> <td>TAPPO SUP CERNIERA VETRO INTERNO SUP</td> <td>1.000</td> <td>PZ</td> </tr> <tr> <td>VT1276A0</td> <td>VETRO ESTERNO SER. XEVC-0511-E</td> <td>1.000</td> <td>PZ</td> </tr> </tbody> </table>	Code	Description	Qty	UOM	VM2959A0	ASSEMBLATO TAPPO SUP SX PORTA MM LEFT	1.000	PZ	VM2960A0	ASSEMBLATO TAPPO INF SX PORTA S6 LEF	1.000	PZ	VM2961A0	ASSEMBLATO TAPPO SUP DX PORTA MM LEFT	1.000	PZ	VP1081A0	TAPPO SUP CERNIERA VETRO INTERNO SUP	1.000	PZ	VT1276A0	VETRO ESTERNO SER. XEVC-0511-E	1.000	PZ									
			Code	Description	Qty	UOM																																
VM2959A0	ASSEMBLATO TAPPO SUP SX PORTA MM LEFT	1.000	PZ																																			
VM2960A0	ASSEMBLATO TAPPO INF SX PORTA S6 LEF	1.000	PZ																																			
VM2961A0	ASSEMBLATO TAPPO SUP DX PORTA MM LEFT	1.000	PZ																																			
VP1081A0	TAPPO SUP CERNIERA VETRO INTERNO SUP	1.000	PZ																																			
VT1276A0	VETRO ESTERNO SER. XEVC-0511-E	1.000	PZ																																			
KDR1325A	0511 ZERO RIGHT -M EXTERNAL DOOR	<table border="1"> <thead> <tr> <th>Code</th> <th>Description</th> <th>Qty</th> <th>UOM</th> </tr> </thead> <tbody> <tr> <td>0B1106A0</td> <td>COLONNINA ESTERNA SX PORTA XEVC-0511-E</td> <td>1.000</td> <td>PZ</td> </tr> <tr> <td>0B1107A1</td> <td>COLONNINA INTERNA SX PORTA XEVC-0511-E</td> <td>1.000</td> <td>PZ</td> </tr> <tr> <td>0B1108B1</td> <td>COLONNINA ESTERNA DX PORTA XEVC-0511</td> <td>1.000</td> <td>PZ</td> </tr> <tr> <td>0B1109A1</td> <td>COLONNINA INTERNA DX PORTA XEVC-0511-E</td> <td>1.000</td> <td>PZ</td> </tr> <tr> <td>0B1122B0</td> <td>TRAVERSO INFERIORE PORTA 750 MMc</td> <td>1.000</td> <td>PZ</td> </tr> <tr> <td>0B1166A1</td> <td>PROFILO SUPPORTO VETRO EST XEVC-0511-E</td> <td>2.000</td> <td>PZ</td> </tr> <tr> <td>0B1216B0</td> <td>TRAVERSO SUPERIORE PORTA 750 2V MMc</td> <td>1.000</td> <td>PZ</td> </tr> <tr> <td>0B1217A1</td> <td>TRAVERSO SUPERIORE INT PORTA 750 S6 2V</td> <td>1.000</td> <td>PZ</td> </tr> </tbody> </table>	Code	Description	Qty	UOM	0B1106A0	COLONNINA ESTERNA SX PORTA XEVC-0511-E	1.000	PZ	0B1107A1	COLONNINA INTERNA SX PORTA XEVC-0511-E	1.000	PZ	0B1108B1	COLONNINA ESTERNA DX PORTA XEVC-0511	1.000	PZ	0B1109A1	COLONNINA INTERNA DX PORTA XEVC-0511-E	1.000	PZ	0B1122B0	TRAVERSO INFERIORE PORTA 750 MMc	1.000	PZ	0B1166A1	PROFILO SUPPORTO VETRO EST XEVC-0511-E	2.000	PZ	0B1216B0	TRAVERSO SUPERIORE PORTA 750 2V MMc	1.000	PZ	0B1217A1	TRAVERSO SUPERIORE INT PORTA 750 S6 2V	1.000	PZ
Code	Description	Qty	UOM																																			
0B1106A0	COLONNINA ESTERNA SX PORTA XEVC-0511-E	1.000	PZ																																			
0B1107A1	COLONNINA INTERNA SX PORTA XEVC-0511-E	1.000	PZ																																			
0B1108B1	COLONNINA ESTERNA DX PORTA XEVC-0511	1.000	PZ																																			
0B1109A1	COLONNINA INTERNA DX PORTA XEVC-0511-E	1.000	PZ																																			
0B1122B0	TRAVERSO INFERIORE PORTA 750 MMc	1.000	PZ																																			
0B1166A1	PROFILO SUPPORTO VETRO EST XEVC-0511-E	2.000	PZ																																			
0B1216B0	TRAVERSO SUPERIORE PORTA 750 2V MMc	1.000	PZ																																			
0B1217A1	TRAVERSO SUPERIORE INT PORTA 750 S6 2V	1.000	PZ																																			

COMPONENT			SPARE PART					
Code	Description	Image	Code	Description	Kit components			
VT1276A	VETRO ESTERNO SER. XEVC-0511-E		KDR1325A	0511 ZERO RIGHT -M EXTERNAL DOOR	Code	Description	Qty	UOM
					0H2892A0	LAMIERINO TAPPO SUP BARRA LED	1.000	PZ
					0H2893A0	LAMIERINO TAPPO INF BARRA LED	1.000	PZ
					CE1096A0	CAVO BUS MICROFIT 4POLI 3 M	1.000	PZ
					CE1285A0	FERRITE EMI ROUND MOD. 2643801502	2.000	PZ
					CE1851A0	CAVO Y MICROFIT 2P M-F-F AWG22	1.000	PZ
					CE2001A0	CAVO MICROFIT 2PM-100-2PM 2AWG22	1.000	PZ
					CE2002A0	CAVO MICROFIT 2PM-100-AMP MODU2 2AWG22	1.000	PZ
					GN1525A0	O-RING D.INT 9.5xSP 1 NBR 7	1.000	PZ
					LP1019A0	BARRA ILLUMINAZION E LED MM L200 E415	1.000	PZ
					MG1099A1	ASSIEME MANIGLIA COMPLETO MMc	1.000	PZ
					SL1170A1	SILICONE ANTRACITE S57 CARTUCCIA 310 ml	30.000	ML
					SL1221A0	SILICONE SUP VETRO EXT GN1/1	1.000	PZ
					SL1222A0	SILICONE LAT VETRO EXT 0511	4.000	PZ
					VE1030A1	CALAMITA D=22,9mm PER MICROPORTA	1.000	PZ
					VI1034A0	RONDELLA PIANA 8.4x16x1 INOX	1.000	PZ
					VI1074A0	VITE PER PLASTICA 4X16 TPBS+ INOX	1.000	PZ

COMPONENT			SPARE PART																																																																															
Code	Description	Image	Code	Description	Kit components																																																																													
VT1276A	VETRO ESTERNO SER. XEVC-0511-E		KDR1325A	0511 ZERO RIGHT -M EXTERNAL DOOR	<table border="1"> <thead> <tr> <th>Code</th> <th>Description</th> <th>Qty</th> <th>UOM</th> </tr> </thead> <tbody> <tr> <td>VI1174A0</td> <td>VITE 5X20 PER PLASTICA ZN-NI</td> <td>16.000</td> <td>PZ</td> </tr> <tr> <td>VI1220A1</td> <td>VITE AUTOFIL. 4.2X11 TCS+ MARUTEX</td> <td>26.000</td> <td>PZ</td> </tr> <tr> <td>VI1996A0</td> <td>VITE M5x35 TCEI ZN</td> <td>13.000</td> <td>PZ</td> </tr> <tr> <td>VM1490A0</td> <td>COPRI VITI MANIGLIA CHEFTOP BAKERTOP</td> <td>2.000</td> <td>PZ</td> </tr> <tr> <td>VM1630A1</td> <td>TAPPO PREMI VETRO INTERNO</td> <td>3.000</td> <td>PZ</td> </tr> <tr> <td>VM1631A0</td> <td>TAPPO PREMI VETRO INTERNO PLU</td> <td>3.000</td> <td>PZ</td> </tr> <tr> <td>VM2259B0</td> <td>TAPPO INF SX PORTA S6</td> <td>1.000</td> <td>PZ</td> </tr> <tr> <td>VM2268A0</td> <td>TAPPO COPRI CALAMITA PORTA</td> <td>1.000</td> <td>PZ</td> </tr> <tr> <td>VM2274A0</td> <td>BOCCOLA SCANALATA CORTA</td> <td>1.000</td> <td>PZ</td> </tr> <tr> <td>VM2275A0</td> <td>BOCCOLA LISCIA CORTA</td> <td>1.000</td> <td>PZ</td> </tr> <tr> <td>VM2284B0</td> <td>PROFILO SALVAGOCCE SERIE 750</td> <td>1.000</td> <td>PZ</td> </tr> <tr> <td>VM2305A0</td> <td>NOTTOLINO FISSAGGIO TAPPI PORTE MM</td> <td>14.000</td> <td>PZ</td> </tr> <tr> <td>VM2312A0</td> <td>TUBETTO SX SCARICO GOCCIOLATOI O MM</td> <td>1.000</td> <td>PZ</td> </tr> <tr> <td>VM2314A0</td> <td>TAPPINO GOCCIOLATOI O MM</td> <td>1.000</td> <td>PZ</td> </tr> <tr> <td>VM2315B0</td> <td>SUPPORTO SPINGI VETRO INT MM -M</td> <td>3.000</td> <td>PZ</td> </tr> <tr> <td>VM2505B1</td> <td>SUPPORTO PREMI VETRO INT MM PLUS</td> <td>3.000</td> <td>PZ</td> </tr> <tr> <td>VM2956A0</td> <td>ASSEMBLATO TAPPO SUP DX PORTA MM -M</td> <td>1.000</td> <td>PZ</td> </tr> <tr> <td>VM2957A0</td> <td>ASSEMBLATO TAPPO INF DX PORTA MM -M</td> <td>1.000</td> <td>PZ</td> </tr> </tbody> </table>	Code	Description	Qty	UOM	VI1174A0	VITE 5X20 PER PLASTICA ZN-NI	16.000	PZ	VI1220A1	VITE AUTOFIL. 4.2X11 TCS+ MARUTEX	26.000	PZ	VI1996A0	VITE M5x35 TCEI ZN	13.000	PZ	VM1490A0	COPRI VITI MANIGLIA CHEFTOP BAKERTOP	2.000	PZ	VM1630A1	TAPPO PREMI VETRO INTERNO	3.000	PZ	VM1631A0	TAPPO PREMI VETRO INTERNO PLU	3.000	PZ	VM2259B0	TAPPO INF SX PORTA S6	1.000	PZ	VM2268A0	TAPPO COPRI CALAMITA PORTA	1.000	PZ	VM2274A0	BOCCOLA SCANALATA CORTA	1.000	PZ	VM2275A0	BOCCOLA LISCIA CORTA	1.000	PZ	VM2284B0	PROFILO SALVAGOCCE SERIE 750	1.000	PZ	VM2305A0	NOTTOLINO FISSAGGIO TAPPI PORTE MM	14.000	PZ	VM2312A0	TUBETTO SX SCARICO GOCCIOLATOI O MM	1.000	PZ	VM2314A0	TAPPINO GOCCIOLATOI O MM	1.000	PZ	VM2315B0	SUPPORTO SPINGI VETRO INT MM -M	3.000	PZ	VM2505B1	SUPPORTO PREMI VETRO INT MM PLUS	3.000	PZ	VM2956A0	ASSEMBLATO TAPPO SUP DX PORTA MM -M	1.000	PZ	VM2957A0	ASSEMBLATO TAPPO INF DX PORTA MM -M	1.000	PZ	
Code	Description	Qty	UOM																																																																															
VI1174A0	VITE 5X20 PER PLASTICA ZN-NI	16.000	PZ																																																																															
VI1220A1	VITE AUTOFIL. 4.2X11 TCS+ MARUTEX	26.000	PZ																																																																															
VI1996A0	VITE M5x35 TCEI ZN	13.000	PZ																																																																															
VM1490A0	COPRI VITI MANIGLIA CHEFTOP BAKERTOP	2.000	PZ																																																																															
VM1630A1	TAPPO PREMI VETRO INTERNO	3.000	PZ																																																																															
VM1631A0	TAPPO PREMI VETRO INTERNO PLU	3.000	PZ																																																																															
VM2259B0	TAPPO INF SX PORTA S6	1.000	PZ																																																																															
VM2268A0	TAPPO COPRI CALAMITA PORTA	1.000	PZ																																																																															
VM2274A0	BOCCOLA SCANALATA CORTA	1.000	PZ																																																																															
VM2275A0	BOCCOLA LISCIA CORTA	1.000	PZ																																																																															
VM2284B0	PROFILO SALVAGOCCE SERIE 750	1.000	PZ																																																																															
VM2305A0	NOTTOLINO FISSAGGIO TAPPI PORTE MM	14.000	PZ																																																																															
VM2312A0	TUBETTO SX SCARICO GOCCIOLATOI O MM	1.000	PZ																																																																															
VM2314A0	TAPPINO GOCCIOLATOI O MM	1.000	PZ																																																																															
VM2315B0	SUPPORTO SPINGI VETRO INT MM -M	3.000	PZ																																																																															
VM2505B1	SUPPORTO PREMI VETRO INT MM PLUS	3.000	PZ																																																																															
VM2956A0	ASSEMBLATO TAPPO SUP DX PORTA MM -M	1.000	PZ																																																																															
VM2957A0	ASSEMBLATO TAPPO INF DX PORTA MM -M	1.000	PZ																																																																															

COMPONENT			SPARE PART																																											
Code	Description	Image	Code	Description	Kit components																																									
VT1276A	VETRO ESTERNO SER. XEVC-0511-E		KDR1325A	0511 ZERO RIGHT -M EXTERNAL DOOR	<table border="1"> <thead> <tr> <th>Code</th> <th>Description</th> <th>Qty</th> <th>UOM</th> </tr> </thead> <tbody> <tr> <td>VM2958A0</td> <td>ASSEMBLATO TAPPO SUP SX PORTA MM -M</td> <td>1.000</td> <td>PZ</td> </tr> <tr> <td>VP1080A0</td> <td>TAPPO SUP CERNIERA VETRO INTERNO INF</td> <td>1.000</td> <td>PZ</td> </tr> <tr> <td>VT1276A0</td> <td>VETRO ESTERNO SER. XEVC-0511-E</td> <td>1.000</td> <td>PZ</td> </tr> </tbody> </table>	Code	Description	Qty	UOM	VM2958A0	ASSEMBLATO TAPPO SUP SX PORTA MM -M	1.000	PZ	VP1080A0	TAPPO SUP CERNIERA VETRO INTERNO INF	1.000	PZ	VT1276A0	VETRO ESTERNO SER. XEVC-0511-E	1.000	PZ																									
			Code	Description	Qty	UOM																																								
VM2958A0	ASSEMBLATO TAPPO SUP SX PORTA MM -M	1.000	PZ																																											
VP1080A0	TAPPO SUP CERNIERA VETRO INTERNO INF	1.000	PZ																																											
VT1276A0	VETRO ESTERNO SER. XEVC-0511-E	1.000	PZ																																											
KDR1265B	0511 -M LEFT EXTERNAL DOOR	<table border="1"> <thead> <tr> <th>Code</th> <th>Description</th> <th>Qty</th> <th>UOM</th> </tr> </thead> <tbody> <tr> <td>0B1122B0</td> <td>TRAVERSO INFERIORE PORTA 750 MMc</td> <td>1.000</td> <td>PZ</td> </tr> <tr> <td>0B1166A1</td> <td>PROFILO SUPPORTO VETRO EST XEVC-0511-E</td> <td>2.000</td> <td>PZ</td> </tr> <tr> <td>0B1195B1</td> <td>COLONNINA ESTERNA SX PORTA 0511 LEFT</td> <td>1.000</td> <td>PZ</td> </tr> <tr> <td>0B1196A1</td> <td>COLONN. INT. DX PORTA 0511 LEFT</td> <td>1.000</td> <td>PZ</td> </tr> <tr> <td>0B1197A1</td> <td>COLONNINA INTERNA SX PORTA 0511 LEFT</td> <td>1.000</td> <td>PZ</td> </tr> <tr> <td>0B1206A0</td> <td>COLONNINA ESTERNA DX PORTA 0511 LEFT</td> <td>1.000</td> <td>PZ</td> </tr> <tr> <td>0B1216B0</td> <td>TRAVERSO SUPERIORE PORTA 750 2V MMc</td> <td>1.000</td> <td>PZ</td> </tr> <tr> <td>0B1217A1</td> <td>TRAVERSO SUPERIORE INT PORTA 750 S8 2V</td> <td>1.000</td> <td>PZ</td> </tr> <tr> <td>CE1052A1</td> <td>CAVO CONNESSION E CONTROLLO- USB MM 750m</td> <td>1.000</td> <td>PZ</td> </tr> <tr> <td>CE1053B0</td> <td>CAVO ALIMENT BARRA LED MM MICROFIT 2P</td> <td>1.000</td> <td>PZ</td> </tr> </tbody> </table>	Code	Description	Qty	UOM	0B1122B0	TRAVERSO INFERIORE PORTA 750 MMc	1.000	PZ	0B1166A1	PROFILO SUPPORTO VETRO EST XEVC-0511-E	2.000	PZ	0B1195B1	COLONNINA ESTERNA SX PORTA 0511 LEFT	1.000	PZ	0B1196A1	COLONN. INT. DX PORTA 0511 LEFT	1.000	PZ	0B1197A1	COLONNINA INTERNA SX PORTA 0511 LEFT	1.000	PZ	0B1206A0	COLONNINA ESTERNA DX PORTA 0511 LEFT	1.000	PZ	0B1216B0	TRAVERSO SUPERIORE PORTA 750 2V MMc	1.000	PZ	0B1217A1	TRAVERSO SUPERIORE INT PORTA 750 S8 2V	1.000	PZ	CE1052A1	CAVO CONNESSION E CONTROLLO- USB MM 750m	1.000	PZ	CE1053B0	CAVO ALIMENT BARRA LED MM MICROFIT 2P	1.000	PZ
Code	Description	Qty	UOM																																											
0B1122B0	TRAVERSO INFERIORE PORTA 750 MMc	1.000	PZ																																											
0B1166A1	PROFILO SUPPORTO VETRO EST XEVC-0511-E	2.000	PZ																																											
0B1195B1	COLONNINA ESTERNA SX PORTA 0511 LEFT	1.000	PZ																																											
0B1196A1	COLONN. INT. DX PORTA 0511 LEFT	1.000	PZ																																											
0B1197A1	COLONNINA INTERNA SX PORTA 0511 LEFT	1.000	PZ																																											
0B1206A0	COLONNINA ESTERNA DX PORTA 0511 LEFT	1.000	PZ																																											
0B1216B0	TRAVERSO SUPERIORE PORTA 750 2V MMc	1.000	PZ																																											
0B1217A1	TRAVERSO SUPERIORE INT PORTA 750 S8 2V	1.000	PZ																																											
CE1052A1	CAVO CONNESSION E CONTROLLO- USB MM 750m	1.000	PZ																																											
CE1053B0	CAVO ALIMENT BARRA LED MM MICROFIT 2P	1.000	PZ																																											

COMPONENT			SPARE PART			
Code	Description	Image	Code	Description	Kit components	
VT1276A	VETRO ESTERNO SER. XEVC-0511-E		KDR1265B	0511 -M LEFT EXTERNAL DOOR	Code	Description Qty UOM
					CE1096A0	CAVO BUS 1.000 PZ MICROFIT 4POLI 3 M
					CE1285A0	FERRITE EMI 2.000 PZ ROUND MOD. 2643801502
					GN1525A0	O-RING D.INT 1.000 PZ 9.5xSP 1 NBR 7
					LP1019A0	BARRA 1.000 PZ ILLUMINAZION E LED MM L200 E415
					LP1025A0	ESTRUSO 1.000 PZ ILLUMINAZION E NO LED MM L415
					MG1099A1	ASSIEME 1.000 PZ MANIGLIA COMPLETO MMc
					SL1155A1	SILICONE 60.000 ML BICOMPONEN TE LOCTITE
					SL1170A1	SILICONE 30.000 ML ANTRACITE S57 CARTUCCIA 310 ml
					SL1221A0	SILICONE SUP 1.000 PZ VETRO EXT GN1/1
					SL1222A0	SILICONE LAT 4.000 PZ VETRO EXT 0511
					VE1030A1	CALAMITA 1.000 PZ D=22,9mm PER MICROPORTA
					VH1034A0	RONDELLA 1.000 PZ PIANA 8.4x16x1 INOX
					VH1074A0	VITE PER 4.000 PZ PLASTICA 4X16 TPBS+ INOX
					VI1174A0	VITE 5X20 PER 16.000 PZ PLASTICA ZN-NI
					VI1220A1	VITE AUTOFIL. 26.000 PZ 4.2X11 TCS+ MARUTEX
					VI1996A0	VITE M5x35 13.000 PZ TCEI ZN

COMPONENT			SPARE PART																																																																							
Code	Description	Image	Code	Description	Kit components																																																																					
VT1276A	VETRO ESTERNO SER. XEVC-0511-E		KDR1265B	0511 -M LEFT EXTERNAL DOOR	<table border="1"> <thead> <tr> <th>Code</th> <th>Description</th> <th>Qty</th> <th>UOM</th> </tr> </thead> <tbody> <tr> <td>VM1490A0</td> <td>COPRI VITI MANIGLIA CHEFTOP BAKERTOP</td> <td>2.000</td> <td>PZ</td> </tr> <tr> <td>VM1630A1</td> <td>TAPPO PREMI VETRO INTERNO</td> <td>3.000</td> <td>PZ</td> </tr> <tr> <td>VM1631A0</td> <td>TAPPO PREMI VETRO INTERNO PLU</td> <td>3.000</td> <td>PZ</td> </tr> <tr> <td>VM2268A0</td> <td>TAPPO COPRI CALAMITA PORTA</td> <td>1.000</td> <td>PZ</td> </tr> <tr> <td>VM2274A0</td> <td>BOCCOLA SCANALATA CORTA</td> <td>1.000</td> <td>PZ</td> </tr> <tr> <td>VM2275A0</td> <td>BOCCOLA LISCIA CORTA</td> <td>1.000</td> <td>PZ</td> </tr> <tr> <td>VM2284B0</td> <td>PROFILO SALVAGOCCE SERIE 750</td> <td>1.000</td> <td>PZ</td> </tr> <tr> <td>VM2305A0</td> <td>NOTTOLINO FISSAGGIO TAPPI PORTE MM</td> <td>14.000</td> <td>PZ</td> </tr> <tr> <td>VM2313A0</td> <td>TUBETTO DX SCARICO GOCCIOLATOI O MM</td> <td>1.000</td> <td>PZ</td> </tr> <tr> <td>VM2314A0</td> <td>TAPPINO GOCCIOLATOI O MM</td> <td>1.000</td> <td>PZ</td> </tr> <tr> <td>VM2315B0</td> <td>SUPPORTO SPINGI VETRO INT MM -M</td> <td>3.000</td> <td>PZ</td> </tr> <tr> <td>VM2384B0</td> <td>TAPPO INF DX PORTA MM LEFT</td> <td>1.000</td> <td>PZ</td> </tr> <tr> <td>VM2505B1</td> <td>SUPPORTO PREMI VETRO INT MM PLUS</td> <td>3.000</td> <td>PZ</td> </tr> <tr> <td>VM3012A0</td> <td>ASSEMBLATO TAPPO SUP DX PORTA MM LEFT -M</td> <td>1.000</td> <td>PZ</td> </tr> <tr> <td>VM3013A0</td> <td>ASSEMBLATO TAPPO SUP SX PORTA MM LEFT -M</td> <td>1.000</td> <td>PZ</td> </tr> <tr> <td>VM3014A0</td> <td>ASSEMBLATO TAPPO INF SX PORTA S6 LEFT -M</td> <td>1.000</td> <td>PZ</td> </tr> </tbody> </table>	Code	Description	Qty	UOM	VM1490A0	COPRI VITI MANIGLIA CHEFTOP BAKERTOP	2.000	PZ	VM1630A1	TAPPO PREMI VETRO INTERNO	3.000	PZ	VM1631A0	TAPPO PREMI VETRO INTERNO PLU	3.000	PZ	VM2268A0	TAPPO COPRI CALAMITA PORTA	1.000	PZ	VM2274A0	BOCCOLA SCANALATA CORTA	1.000	PZ	VM2275A0	BOCCOLA LISCIA CORTA	1.000	PZ	VM2284B0	PROFILO SALVAGOCCE SERIE 750	1.000	PZ	VM2305A0	NOTTOLINO FISSAGGIO TAPPI PORTE MM	14.000	PZ	VM2313A0	TUBETTO DX SCARICO GOCCIOLATOI O MM	1.000	PZ	VM2314A0	TAPPINO GOCCIOLATOI O MM	1.000	PZ	VM2315B0	SUPPORTO SPINGI VETRO INT MM -M	3.000	PZ	VM2384B0	TAPPO INF DX PORTA MM LEFT	1.000	PZ	VM2505B1	SUPPORTO PREMI VETRO INT MM PLUS	3.000	PZ	VM3012A0	ASSEMBLATO TAPPO SUP DX PORTA MM LEFT -M	1.000	PZ	VM3013A0	ASSEMBLATO TAPPO SUP SX PORTA MM LEFT -M	1.000	PZ	VM3014A0	ASSEMBLATO TAPPO INF SX PORTA S6 LEFT -M	1.000	PZ	
Code	Description	Qty	UOM																																																																							
VM1490A0	COPRI VITI MANIGLIA CHEFTOP BAKERTOP	2.000	PZ																																																																							
VM1630A1	TAPPO PREMI VETRO INTERNO	3.000	PZ																																																																							
VM1631A0	TAPPO PREMI VETRO INTERNO PLU	3.000	PZ																																																																							
VM2268A0	TAPPO COPRI CALAMITA PORTA	1.000	PZ																																																																							
VM2274A0	BOCCOLA SCANALATA CORTA	1.000	PZ																																																																							
VM2275A0	BOCCOLA LISCIA CORTA	1.000	PZ																																																																							
VM2284B0	PROFILO SALVAGOCCE SERIE 750	1.000	PZ																																																																							
VM2305A0	NOTTOLINO FISSAGGIO TAPPI PORTE MM	14.000	PZ																																																																							
VM2313A0	TUBETTO DX SCARICO GOCCIOLATOI O MM	1.000	PZ																																																																							
VM2314A0	TAPPINO GOCCIOLATOI O MM	1.000	PZ																																																																							
VM2315B0	SUPPORTO SPINGI VETRO INT MM -M	3.000	PZ																																																																							
VM2384B0	TAPPO INF DX PORTA MM LEFT	1.000	PZ																																																																							
VM2505B1	SUPPORTO PREMI VETRO INT MM PLUS	3.000	PZ																																																																							
VM3012A0	ASSEMBLATO TAPPO SUP DX PORTA MM LEFT -M	1.000	PZ																																																																							
VM3013A0	ASSEMBLATO TAPPO SUP SX PORTA MM LEFT -M	1.000	PZ																																																																							
VM3014A0	ASSEMBLATO TAPPO INF SX PORTA S6 LEFT -M	1.000	PZ																																																																							

COMPONENT			SPARE PART																																															
Code	Description	Image	Code	Description	Kit components																																													
VT1276A	VETRO ESTERNO SER. XEVC-0511-E		KDR1265B	0511 -M LEFT EXTERNAL DOOR	<table border="1"> <thead> <tr> <th>Code</th> <th>Description</th> <th>Qty</th> <th>UOM</th> </tr> </thead> <tbody> <tr> <td>VP1081A0</td> <td>TAPPO SUP CERNIERA VETRO INTERNO SUP</td> <td>1.000</td> <td>PZ</td> </tr> <tr> <td>VT1276A0</td> <td>VETRO ESTERNO SER. XEVC-0511-E</td> <td>1.000</td> <td>PZ</td> </tr> </tbody> </table>	Code	Description	Qty	UOM	VP1081A0	TAPPO SUP CERNIERA VETRO INTERNO SUP	1.000	PZ	VT1276A0	VETRO ESTERNO SER. XEVC-0511-E	1.000	PZ																																	
			Code	Description	Qty	UOM																																												
VP1081A0	TAPPO SUP CERNIERA VETRO INTERNO SUP	1.000	PZ																																															
VT1276A0	VETRO ESTERNO SER. XEVC-0511-E	1.000	PZ																																															
KDR1265A	0511 LEFT EXTERNAL DOOR	<table border="1"> <thead> <tr> <th>Code</th> <th>Description</th> <th>Qty</th> <th>UOM</th> </tr> </thead> <tbody> <tr> <td>0B1122A1</td> <td>TRAVERSO INFERIORE PORTA 750 S6</td> <td>1.000</td> <td>PZ</td> </tr> <tr> <td>0B1166A1</td> <td>PROFILO SUPPORTO VETRO EST XEVC-0511-E</td> <td>2.000</td> <td>PZ</td> </tr> <tr> <td>0B1195B1</td> <td>COLONNINA ESTERNA SX PORTA 0511 LEFT</td> <td>1.000</td> <td>PZ</td> </tr> <tr> <td>0B1196A1</td> <td>COLONN. INT. DX PORTA 0511 LEFT</td> <td>1.000</td> <td>PZ</td> </tr> <tr> <td>0B1197A1</td> <td>COLONNINA INTERNA SX PORTA 0511 LEFT</td> <td>1.000</td> <td>PZ</td> </tr> <tr> <td>0B1206A0</td> <td>COLONNINA ESTERNA DX PORTA 0511 LEFT</td> <td>1.000</td> <td>PZ</td> </tr> <tr> <td>0B1216A1</td> <td>TRAVERSO SUPERIORE PORTA 750mm MM 2V</td> <td>1.000</td> <td>PZ</td> </tr> <tr> <td>0B1217A1</td> <td>TRAVERSO SUPERIORE INT PORTA 750 S6 2V</td> <td>1.000</td> <td>PZ</td> </tr> <tr> <td>CE1052A1</td> <td>CAVO CONNESSION E CONTROLLO- USB MM 750m</td> <td>1.000</td> <td>PZ</td> </tr> <tr> <td>CE1053B0</td> <td>CAVO ALIMENT BARRA LED MM MICROFIT 2P</td> <td>1.000</td> <td>PZ</td> </tr> <tr> <td>CE1275A0</td> <td>CAVO COLLEGAMEN TO POTENZA CONTROLLO 3 M</td> <td>1.000</td> <td>PZ</td> </tr> </tbody> </table>	Code	Description	Qty	UOM	0B1122A1	TRAVERSO INFERIORE PORTA 750 S6	1.000	PZ	0B1166A1	PROFILO SUPPORTO VETRO EST XEVC-0511-E	2.000	PZ	0B1195B1	COLONNINA ESTERNA SX PORTA 0511 LEFT	1.000	PZ	0B1196A1	COLONN. INT. DX PORTA 0511 LEFT	1.000	PZ	0B1197A1	COLONNINA INTERNA SX PORTA 0511 LEFT	1.000	PZ	0B1206A0	COLONNINA ESTERNA DX PORTA 0511 LEFT	1.000	PZ	0B1216A1	TRAVERSO SUPERIORE PORTA 750mm MM 2V	1.000	PZ	0B1217A1	TRAVERSO SUPERIORE INT PORTA 750 S6 2V	1.000	PZ	CE1052A1	CAVO CONNESSION E CONTROLLO- USB MM 750m	1.000	PZ	CE1053B0	CAVO ALIMENT BARRA LED MM MICROFIT 2P	1.000	PZ	CE1275A0	CAVO COLLEGAMEN TO POTENZA CONTROLLO 3 M	1.000	PZ
Code	Description	Qty	UOM																																															
0B1122A1	TRAVERSO INFERIORE PORTA 750 S6	1.000	PZ																																															
0B1166A1	PROFILO SUPPORTO VETRO EST XEVC-0511-E	2.000	PZ																																															
0B1195B1	COLONNINA ESTERNA SX PORTA 0511 LEFT	1.000	PZ																																															
0B1196A1	COLONN. INT. DX PORTA 0511 LEFT	1.000	PZ																																															
0B1197A1	COLONNINA INTERNA SX PORTA 0511 LEFT	1.000	PZ																																															
0B1206A0	COLONNINA ESTERNA DX PORTA 0511 LEFT	1.000	PZ																																															
0B1216A1	TRAVERSO SUPERIORE PORTA 750mm MM 2V	1.000	PZ																																															
0B1217A1	TRAVERSO SUPERIORE INT PORTA 750 S6 2V	1.000	PZ																																															
CE1052A1	CAVO CONNESSION E CONTROLLO- USB MM 750m	1.000	PZ																																															
CE1053B0	CAVO ALIMENT BARRA LED MM MICROFIT 2P	1.000	PZ																																															
CE1275A0	CAVO COLLEGAMEN TO POTENZA CONTROLLO 3 M	1.000	PZ																																															

COMPONENT			SPARE PART			
Code	Description	Image	Code	Description	Kit components	
VT1276A	VETRO ESTERNO SER. XEVC-0511-E		KDR1265A	0511 LEFT EXTERNAL DOOR	Code	Description Qty UOM
					CE1285A0	FERRITE EMI 1.000 PZ ROUND MOD. 2643801502
					CE1290A0	MORSETTO 1.000 PZ FEMMINA ESTRAIBILE CPF 5/4
					GN1525A0	O-RING D.INT 1.000 PZ 9.5xSP 1 NBR 7
					LP1019A0	BARRA 1.000 PZ ILLUMINAZION E LED MM L200 E415
					LP1025A0	ESTRUSO 1.000 PZ ILLUMINAZION E NO LED MM L415
					MG1083A2	ASSIEME 1.000 PZ MANIGLIA COMPLETO M
					SL1170A1	SILICONE 21.000 ML ANTRACITE S57 CARTUCCIA 310 ml
					VE1030A1	CALAMITA 1.000 PZ D=22,9mm PER MICROPORTA
					VH1034A0	RONDELLA 1.000 PZ PIANA 8.4x16x1 INOX
					VH1147A0	VITE 5X25 16.000 PZ TRUCIOLARE INOX
					VH1220A1	VITE AUTOFIL. 23.000 PZ 4.2X11 TCS+ MARUTEX
					VH1996A0	VITE M5x35 13.000 PZ TCEI ZN
					VM1630A1	TAPPO PREMI 1.000 PZ VETRO INTERNO
					VM1631A0	TAPPO PREMI 2.000 PZ VETRO INTERNO PLU
					VM2260A1	TAPPO SUP 1.000 PZ SX PORTA S6
					VM2267A1	CORSOIO 2.000 PZ SISTEMA FERMA VETRO INT
					VM2268A0	TAPPO COPRI 2.000 PZ CALAMITA PORTA

COMPONENT			SPARE PART					
Code	Description	Image	Code	Description	Kit components			
VT1276A	VETRO ESTERNO SER. XEVC-0511-E		KDR1265A	0511 LEFT EXTERNAL DOOR	Code	Description	Qty	UOM
					VM2269A0	TAPPO SISTEMA FERMA VETRO INT	2.000	PZ
					VM2274A0	BOCCOLA SCANALATA CORTA	1.000	PZ
					VM2275A0	BOCCOLA LISCIA CORTA	1.000	PZ
					VM2284A0	PROFILO SALVAGOCCE SERIE 750	1.000	PZ
					VM2305A0	NOTTOLINO FISSAGGIO TAPPI PORTE MM	14.000	PZ
					VM2312A0	TUBETTO SX SCARICO GOCCIOLATOI O MM	1.000	PZ
					VM2313A0	TUBETTO DX SCARICO GOCCIOLATOI O MM	1.000	PZ
					VM2314A0	TAPPINO GOCCIOLATOI O MM	1.000	PZ
					VM2315A0	SUPPORTO SPINGI VETRO INT MM	1.000	PZ
					VM2383A0	TAPPO SUP DX PORTA MM LEFT	1.000	PZ
					VM2385A1	TAPPO SUP SX PORTA MM LEFT	1.000	PZ
					VM2386A1	TAPPO INF SX PORTA MM LEFT	1.000	PZ
					VM2505A0	SUPPORTO PREMI VETRO INT MM PLUS	2.000	PZ
					VM2518A0	SUPPORTO VENTOLA RAFF CRUS 20X20 H20	1.000	PZ
					VN1179A1	VENTIL ASSIALE 40x40x20mm 12Vcc	1.000	PZ
					VT1276A0	VETRO ESTERNO SER. XEVC-0511-E	1.000	PZ

COMPONENT			SPARE PART					
Code	Description	Image	Code	Description	Kit components			
VT1276A	VETRO ESTERNO SER. XEVC-0511-E		KDR1261B	0511 -M RIGHT EXTERNAL DOOR	Code	Description	Qty	UOM
					0B1106A0	COLONNINA ESTERNA SX PORTA XEVC-0511-E	1.000	PZ
					0B1107A1	COLONNINA INTERNA SX PORTA XEVC-0511-E	1.000	PZ
					0B1108B1	COLONNINA ESTERNA DX PORTA XEVC-0511	1.000	PZ
					0B1109A1	COLONNINA INTERNA DX PORTA XEVC-0511-E	1.000	PZ
					0B1122B0	TRAVERSO INFERIORE PORTA 750 MMc	1.000	PZ
					0B1166A1	PROFILO SUPPORTO VETRO EST XEVC-0511-E	2.000	PZ
					0B1216B0	TRAVERSO SUPERIORE PORTA 750 2V MMc	1.000	PZ
					0B1217A1	TRAVERSO SUPERIORE INT PORTA 750 S6 2V	1.000	PZ
					CE1052A1	CAVO CONNESSION E CONTROLLO- USB MM 750m	1.000	PZ
					CE1053B0	CAVO ALIMENT BARRA LED MM MICROFIT 2P	1.000	PZ
					CE1096A0	CAVO BUS MICROFIT 4POLI 3 M	1.000	PZ
					CE1285A0	FERRITE EMI ROUND MOD. 2643801502	2.000	PZ
					GN1525A0	O-RING D.INT 9.5xSP 1 NBR 7	1.000	PZ
					LP1019A0	BARRA ILLUMINAZION E LED MM L200 E415	1.000	PZ

COMPONENT			SPARE PART			
Code	Description	Image	Code	Description	Kit components	
VT1276A	VETRO ESTERNO SER. XEVC-0511-E		KDR1261B	0511 -M RIGHT EXTERNAL DOOR	Code	Description Qty UOM
					LP1025A0	ESTRUSO 1.000 PZ ILLUMINAZION E NO LED MM L415
					MG1099A1	ASSIEME 1.000 PZ MANIGLIA COMPLETO MMc
					SL1170A1	SILICONE 30.000 ML ANTRACITE S57 CARTUCCIA 310 ml
					SL1221A0	SILICONE SUP 1.000 PZ VETRO EXT GN1/1
					SL1222A0	SILICONE LAT 4.000 PZ VETRO EXT 0511
					VE1030A1	CALAMITA 1.000 PZ D=22,9mm PER MICROPORTA
					VI1034A0	RONDELLA 1.000 PZ PIANA 8.4x16x1 INOX
					VI1074A0	VITE PER 1.000 PZ PLASTICA 4X16 TPBS+ INOX
					VI1174A0	VITE 5X20 PER 16.000 PZ PLASTICA ZN-NI
					VI1220A1	VITE AUTOFIL. 26.000 PZ 4.2X11 TCS+ MARUTEX
					VI1996A0	VITE M5x35 13.000 PZ TCEI ZN
					VM1490A0	COPRI VITI 2.000 PZ MANIGLIA CHEFTOP BAKERTOP
					VM1630A1	TAPPO PREMI 3.000 PZ VETRO INTERNO
					VM1631A0	TAPPO PREMI 3.000 PZ VETRO INTERNO PLU
					VM2259B0	TAPPO INF SX 1.000 PZ PORTA S6
					VM2268A0	TAPPO COPRI 1.000 PZ CALAMITA PORTA
					VM2274A0	BOCCOLA 1.000 PZ SCANALATA CORTA

COMPONENT			SPARE PART																																																																									
Code	Description	Image	Code	Description	Kit components																																																																							
VT1276A	VETRO ESTERNO SER. XEVC-0511-E		KDR1261B	0511 -M RIGHT EXTERNAL DOOR	<table border="1"> <thead> <tr> <th>Code</th> <th>Description</th> <th>Qty</th> <th>UOM</th> </tr> </thead> <tbody> <tr> <td>VM2275A0</td> <td>BOCCOLA LISCIA CORTA</td> <td>1.000</td> <td>PZ</td> </tr> <tr> <td>VM2284B0</td> <td>PROFILO SALVAGOCCE SERIE 750</td> <td>1.000</td> <td>PZ</td> </tr> <tr> <td>VM2305A0</td> <td>NOTTOLINO FISSAGGIO TAPPI PORTE MM</td> <td>14.000</td> <td>PZ</td> </tr> <tr> <td>VM2312A0</td> <td>TUBETTO SX SCARICO GOCCIOLATOI O MM</td> <td>1.000</td> <td>PZ</td> </tr> <tr> <td>VM2314A0</td> <td>TAPPINO GOCCIOLATOI O MM</td> <td>1.000</td> <td>PZ</td> </tr> <tr> <td>VM2315B0</td> <td>SUPPORTO SPINGI VETRO INT MM -M</td> <td>3.000</td> <td>PZ</td> </tr> <tr> <td>VM2505B1</td> <td>SUPPORTO PREMI VETRO INT MM PLUS</td> <td>3.000</td> <td>PZ</td> </tr> <tr> <td>VM3008A0</td> <td>ASSEMBLATO TAPPO SUP DX PORTA MM -MV</td> <td>1.000</td> <td>PZ</td> </tr> <tr> <td>VM3010A0</td> <td>ASSEMBLATO TAPPO INF DX PORTA MM -M</td> <td>1.000</td> <td>PZ</td> </tr> <tr> <td>VM3011A0</td> <td>ASSEMBLATO TAPPO SUP SX PORTA S6 -MV</td> <td>1.000</td> <td>PZ</td> </tr> <tr> <td>VP1080A0</td> <td>TAPPO SUP CERNIERA VETRO INTERNO INF</td> <td>1.000</td> <td>PZ</td> </tr> <tr> <td>VT1276A0</td> <td>VETRO ESTERNO SER. XEVC-0511-E</td> <td>1.000</td> <td>PZ</td> </tr> </tbody> </table>	Code	Description	Qty	UOM	VM2275A0	BOCCOLA LISCIA CORTA	1.000	PZ	VM2284B0	PROFILO SALVAGOCCE SERIE 750	1.000	PZ	VM2305A0	NOTTOLINO FISSAGGIO TAPPI PORTE MM	14.000	PZ	VM2312A0	TUBETTO SX SCARICO GOCCIOLATOI O MM	1.000	PZ	VM2314A0	TAPPINO GOCCIOLATOI O MM	1.000	PZ	VM2315B0	SUPPORTO SPINGI VETRO INT MM -M	3.000	PZ	VM2505B1	SUPPORTO PREMI VETRO INT MM PLUS	3.000	PZ	VM3008A0	ASSEMBLATO TAPPO SUP DX PORTA MM -MV	1.000	PZ	VM3010A0	ASSEMBLATO TAPPO INF DX PORTA MM -M	1.000	PZ	VM3011A0	ASSEMBLATO TAPPO SUP SX PORTA S6 -MV	1.000	PZ	VP1080A0	TAPPO SUP CERNIERA VETRO INTERNO INF	1.000	PZ	VT1276A0	VETRO ESTERNO SER. XEVC-0511-E	1.000	PZ	KDR1261A	0511 RIGHT EXTERNAL DOOR	<table border="1"> <thead> <tr> <th>Code</th> <th>Description</th> <th>Qty</th> <th>UOM</th> </tr> </thead> <tbody> <tr> <td>0B1106A0</td> <td>COLONNINA ESTERNA SX PORTA XEVC-0511-E</td> <td>1.000</td> <td>PZ</td> </tr> <tr> <td>0B1107A1</td> <td>COLONNINA INTERNA SX PORTA XEVC-0511-E</td> <td>1.000</td> <td>PZ</td> </tr> <tr> <td>0B1108B1</td> <td>COLONNINA ESTERNA DX PORTA XEVC-0511</td> <td>1.000</td> <td>PZ</td> </tr> </tbody> </table>	Code	Description	Qty	UOM	0B1106A0	COLONNINA ESTERNA SX PORTA XEVC-0511-E	1.000	PZ	0B1107A1	COLONNINA INTERNA SX PORTA XEVC-0511-E	1.000	PZ	0B1108B1	COLONNINA ESTERNA DX PORTA XEVC-0511	1.000	PZ
			Code	Description	Qty	UOM																																																																						
VM2275A0	BOCCOLA LISCIA CORTA	1.000	PZ																																																																									
VM2284B0	PROFILO SALVAGOCCE SERIE 750	1.000	PZ																																																																									
VM2305A0	NOTTOLINO FISSAGGIO TAPPI PORTE MM	14.000	PZ																																																																									
VM2312A0	TUBETTO SX SCARICO GOCCIOLATOI O MM	1.000	PZ																																																																									
VM2314A0	TAPPINO GOCCIOLATOI O MM	1.000	PZ																																																																									
VM2315B0	SUPPORTO SPINGI VETRO INT MM -M	3.000	PZ																																																																									
VM2505B1	SUPPORTO PREMI VETRO INT MM PLUS	3.000	PZ																																																																									
VM3008A0	ASSEMBLATO TAPPO SUP DX PORTA MM -MV	1.000	PZ																																																																									
VM3010A0	ASSEMBLATO TAPPO INF DX PORTA MM -M	1.000	PZ																																																																									
VM3011A0	ASSEMBLATO TAPPO SUP SX PORTA S6 -MV	1.000	PZ																																																																									
VP1080A0	TAPPO SUP CERNIERA VETRO INTERNO INF	1.000	PZ																																																																									
VT1276A0	VETRO ESTERNO SER. XEVC-0511-E	1.000	PZ																																																																									
Code	Description	Qty	UOM																																																																									
0B1106A0	COLONNINA ESTERNA SX PORTA XEVC-0511-E	1.000	PZ																																																																									
0B1107A1	COLONNINA INTERNA SX PORTA XEVC-0511-E	1.000	PZ																																																																									
0B1108B1	COLONNINA ESTERNA DX PORTA XEVC-0511	1.000	PZ																																																																									

COMPONENT			SPARE PART					
Code	Description	Image	Code	Description	Kit components			
VT1276A	VETRO ESTERNO SER. XEVC-0511-E		KDR1261A	0511 RIGHT EXTERNAL DOOR	Code	Description	Qty	UOM
					0B1109A1	COLONNINA INTERNA DX PORTA XEVC-0511-E	1.000	PZ
					0B1122A1	TRAVERSO INFERIORE PORTA 750 S6	1.000	PZ
					0B1166A1	PROFILO SUPPORTO VETRO EST XEVC-0511-E	2.000	PZ
					0B1216A1	TRAVERSO SUPERIORE PORTA 750mm MM 2V	1.000	PZ
					0B1217A1	TRAVERSO SUPERIORE INT PORTA 750 S6 2V	1.000	PZ
					CE1052A1	CAVO CONNESSION E CONTROLLO- USB MM 750m	1.000	PZ
					CE1053B0	CAVO ALIMENT BARRA LED MM MICROFIT 2P	1.000	PZ
					CE1275A0	CAVO COLLEGAMEN TO POTENZA CONTROLLO 3 M	1.000	PZ
					CE1285A0	FERRITE EMI ROUND MOD. 2643801502	1.000	PZ
					CE1290A0	MORSETTO FEMMINA ESTRAIBILE CPF 5/4	1.000	PZ
					GN1525A0	O-RING D.INT 9.5xSP 1 NBR 7	1.000	PZ
					LP1019A0	BARRA ILLUMINAZION E LED MM L200 E415	1.000	PZ
					LP1025A0	ESTRUSO ILLUMINAZION E NO LED MM L415	1.000	PZ
					MG1083A2	ASSIEME MANIGLIA COMPLETO M	1.000	PZ

COMPONENT			SPARE PART																																																																														
Code	Description	Image	Code	Description	Kit components																																																																												
VT1276A	VETRO ESTERNO SER. XEVC-0511-E		KDR1261A	0511 RIGHT EXTERNAL DOOR	<table border="1"> <thead> <tr> <th>Code</th> <th>Description</th> <th>Qty</th> <th>UOM</th> </tr> </thead> <tbody> <tr> <td>SL1170A1</td> <td>SILICONE ANTRACITE S57 CARTUCCIA 310 ml</td> <td>30.000</td> <td>ML</td> </tr> <tr> <td>VE1030A1</td> <td>CALAMITA D=22,9mm PER MICROPORTA</td> <td>1.000</td> <td>PZ</td> </tr> <tr> <td>VI1034A0</td> <td>RONDELLA PIANA 8.4x16x1 INOX</td> <td>1.000</td> <td>PZ</td> </tr> <tr> <td>VI1147A0</td> <td>VITE 5X25 TRUCIOLARE INOX</td> <td>16.000</td> <td>PZ</td> </tr> <tr> <td>VI1220A1</td> <td>VITE AUTOFIL. 4.2X11 TCS+ MARUTEX</td> <td>25.000</td> <td>PZ</td> </tr> <tr> <td>VI1996A0</td> <td>VITE M5x35 TCEI ZN</td> <td>13.000</td> <td>PZ</td> </tr> <tr> <td>VM1630A1</td> <td>TAPPO PREMI VETRO INTERNO</td> <td>3.000</td> <td>PZ</td> </tr> <tr> <td>VM1631A0</td> <td>TAPPO PREMI VETRO INTERNO PLU</td> <td>2.000</td> <td>PZ</td> </tr> <tr> <td>VM2259A1</td> <td>TAPPO INF SX PORTA S6</td> <td>1.000</td> <td>PZ</td> </tr> <tr> <td>VM2260A1</td> <td>TAPPO SUP SX PORTA S6</td> <td>1.000</td> <td>PZ</td> </tr> <tr> <td>VM2261A1</td> <td>TAPPO INF DX PORTA MM</td> <td>1.000</td> <td>PZ</td> </tr> <tr> <td>VM2262A1</td> <td>TAPPO SUP DX PORTA MM</td> <td>1.000</td> <td>PZ</td> </tr> <tr> <td>VM2267A1</td> <td>CORSOIO SISTEMA FERMA VETRO INT</td> <td>2.000</td> <td>PZ</td> </tr> <tr> <td>VM2268A0</td> <td>TAPPO COPRI CALAMITA PORTA</td> <td>2.000</td> <td>PZ</td> </tr> <tr> <td>VM2269A0</td> <td>TAPPO SISTEMA FERMA VETRO INT</td> <td>2.000</td> <td>PZ</td> </tr> <tr> <td>VM2274A0</td> <td>BOCCOLA SCANALATA CORTA</td> <td>1.000</td> <td>PZ</td> </tr> <tr> <td>VM2275A0</td> <td>BOCCOLA LISCIA CORTA</td> <td>1.000</td> <td>PZ</td> </tr> <tr> <td>VM2284A0</td> <td>PROFILO SALVAGOCCE SERIE 750</td> <td>1.000</td> <td>PZ</td> </tr> </tbody> </table>	Code	Description	Qty	UOM	SL1170A1	SILICONE ANTRACITE S57 CARTUCCIA 310 ml	30.000	ML	VE1030A1	CALAMITA D=22,9mm PER MICROPORTA	1.000	PZ	VI1034A0	RONDELLA PIANA 8.4x16x1 INOX	1.000	PZ	VI1147A0	VITE 5X25 TRUCIOLARE INOX	16.000	PZ	VI1220A1	VITE AUTOFIL. 4.2X11 TCS+ MARUTEX	25.000	PZ	VI1996A0	VITE M5x35 TCEI ZN	13.000	PZ	VM1630A1	TAPPO PREMI VETRO INTERNO	3.000	PZ	VM1631A0	TAPPO PREMI VETRO INTERNO PLU	2.000	PZ	VM2259A1	TAPPO INF SX PORTA S6	1.000	PZ	VM2260A1	TAPPO SUP SX PORTA S6	1.000	PZ	VM2261A1	TAPPO INF DX PORTA MM	1.000	PZ	VM2262A1	TAPPO SUP DX PORTA MM	1.000	PZ	VM2267A1	CORSOIO SISTEMA FERMA VETRO INT	2.000	PZ	VM2268A0	TAPPO COPRI CALAMITA PORTA	2.000	PZ	VM2269A0	TAPPO SISTEMA FERMA VETRO INT	2.000	PZ	VM2274A0	BOCCOLA SCANALATA CORTA	1.000	PZ	VM2275A0	BOCCOLA LISCIA CORTA	1.000	PZ	VM2284A0	PROFILO SALVAGOCCE SERIE 750	1.000	PZ
Code	Description	Qty	UOM																																																																														
SL1170A1	SILICONE ANTRACITE S57 CARTUCCIA 310 ml	30.000	ML																																																																														
VE1030A1	CALAMITA D=22,9mm PER MICROPORTA	1.000	PZ																																																																														
VI1034A0	RONDELLA PIANA 8.4x16x1 INOX	1.000	PZ																																																																														
VI1147A0	VITE 5X25 TRUCIOLARE INOX	16.000	PZ																																																																														
VI1220A1	VITE AUTOFIL. 4.2X11 TCS+ MARUTEX	25.000	PZ																																																																														
VI1996A0	VITE M5x35 TCEI ZN	13.000	PZ																																																																														
VM1630A1	TAPPO PREMI VETRO INTERNO	3.000	PZ																																																																														
VM1631A0	TAPPO PREMI VETRO INTERNO PLU	2.000	PZ																																																																														
VM2259A1	TAPPO INF SX PORTA S6	1.000	PZ																																																																														
VM2260A1	TAPPO SUP SX PORTA S6	1.000	PZ																																																																														
VM2261A1	TAPPO INF DX PORTA MM	1.000	PZ																																																																														
VM2262A1	TAPPO SUP DX PORTA MM	1.000	PZ																																																																														
VM2267A1	CORSOIO SISTEMA FERMA VETRO INT	2.000	PZ																																																																														
VM2268A0	TAPPO COPRI CALAMITA PORTA	2.000	PZ																																																																														
VM2269A0	TAPPO SISTEMA FERMA VETRO INT	2.000	PZ																																																																														
VM2274A0	BOCCOLA SCANALATA CORTA	1.000	PZ																																																																														
VM2275A0	BOCCOLA LISCIA CORTA	1.000	PZ																																																																														
VM2284A0	PROFILO SALVAGOCCE SERIE 750	1.000	PZ																																																																														



COMPONENT			SPARE PART																																						
Code	Description	Image	Code	Description	Kit components																																				
VT1276A	VETRO ESTERNO SER. XEVC-0511-E		KDR1261A	0511 RIGHT EXTERNAL DOOR	<table border="1"> <thead> <tr> <th>Code</th> <th>Description</th> <th>Qty</th> <th>UOM</th> </tr> </thead> <tbody> <tr> <td>VM2305A0</td> <td>NOTTOLINO FISSAGGIO TAPPI PORTE MM</td> <td>14.000</td> <td>PZ</td> </tr> <tr> <td>VM2312A0</td> <td>TUBETTO SX SCARICO GOCCIOLATOI O MM</td> <td>1.000</td> <td>PZ</td> </tr> <tr> <td>VM2314A0</td> <td>TAPPINO GOCCIOLATOI O MM</td> <td>1.000</td> <td>PZ</td> </tr> <tr> <td>VM2315A0</td> <td>SUPPORTO SPINGI VETRO INT MM</td> <td>3.000</td> <td>PZ</td> </tr> <tr> <td>VM2505A0</td> <td>SUPPORTO PREMI VETRO INT MM PLUS</td> <td>2.000</td> <td>PZ</td> </tr> <tr> <td>VM2518A0</td> <td>SUPPORTO VENTOLA RAFF CRUS 20X20 H20</td> <td>1.000</td> <td>PZ</td> </tr> <tr> <td>VN1179A1</td> <td>VENTIL ASSIALE 40x40x20mm 12Vcc</td> <td>1.000</td> <td>PZ</td> </tr> <tr> <td>VT1276A0</td> <td>VETRO ESTERNO SER. XEVC-0511-E</td> <td>1.000</td> <td>PZ</td> </tr> </tbody> </table>	Code	Description	Qty	UOM	VM2305A0	NOTTOLINO FISSAGGIO TAPPI PORTE MM	14.000	PZ	VM2312A0	TUBETTO SX SCARICO GOCCIOLATOI O MM	1.000	PZ	VM2314A0	TAPPINO GOCCIOLATOI O MM	1.000	PZ	VM2315A0	SUPPORTO SPINGI VETRO INT MM	3.000	PZ	VM2505A0	SUPPORTO PREMI VETRO INT MM PLUS	2.000	PZ	VM2518A0	SUPPORTO VENTOLA RAFF CRUS 20X20 H20	1.000	PZ	VN1179A1	VENTIL ASSIALE 40x40x20mm 12Vcc	1.000	PZ	VT1276A0	VETRO ESTERNO SER. XEVC-0511-E	1.000	PZ
Code	Description	Qty	UOM																																						
VM2305A0	NOTTOLINO FISSAGGIO TAPPI PORTE MM	14.000	PZ																																						
VM2312A0	TUBETTO SX SCARICO GOCCIOLATOI O MM	1.000	PZ																																						
VM2314A0	TAPPINO GOCCIOLATOI O MM	1.000	PZ																																						
VM2315A0	SUPPORTO SPINGI VETRO INT MM	3.000	PZ																																						
VM2505A0	SUPPORTO PREMI VETRO INT MM PLUS	2.000	PZ																																						
VM2518A0	SUPPORTO VENTOLA RAFF CRUS 20X20 H20	1.000	PZ																																						
VN1179A1	VENTIL ASSIALE 40x40x20mm 12Vcc	1.000	PZ																																						
VT1276A0	VETRO ESTERNO SER. XEVC-0511-E	1.000	PZ																																						



ASM2926A/0.D06 - Electrical system - FRONT





ASM2926A/0.D06 - Electrical system - REAR

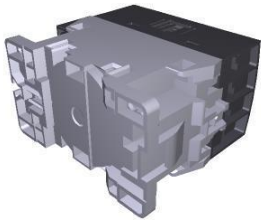

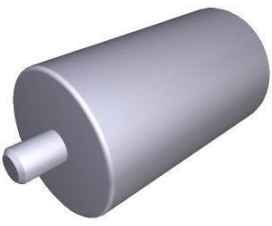
COMPONENT			SPARE PART																						
Code	Description	Image	Code	Description	Kit components																				
0H7250A	S6 ONE GN1-1 COMPONENT HOLDEER PROFILE		0H7250A1	S6 ONE GN1-1 COMPONENT HOLDEER PROFILE																					
VE1644A	DADO PRESSACAVO PG 29		KVE1645A	REDUCED PG 29 STRAIN RELIEF + NUT KIT	<table border="1"> <thead> <tr> <th>Code</th> <th>Description</th> <th>Qty</th> <th>UOM</th> </tr> </thead> <tbody> <tr> <td>VE1644A0</td> <td>DADO PRESSACAVO PG 29</td> <td>1.000</td> <td>PZ</td> </tr> <tr> <td>VE1645A1</td> <td>PRESSACAVO PG 29 RIDOTT</td> <td>1.000</td> <td>PZ</td> </tr> </tbody> </table>	Code	Description	Qty	UOM	VE1644A0	DADO PRESSACAVO PG 29	1.000	PZ	VE1645A1	PRESSACAVO PG 29 RIDOTT	1.000	PZ								
Code	Description	Qty	UOM																						
VE1644A0	DADO PRESSACAVO PG 29	1.000	PZ																						
VE1645A1	PRESSACAVO PG 29 RIDOTT	1.000	PZ																						
VE1645A	PRESSACAVO PG 29 RIDOTTO		KVE1645A	REDUCED PG 29 STRAIN RELIEF + NUT KIT	<table border="1"> <thead> <tr> <th>Code</th> <th>Description</th> <th>Qty</th> <th>UOM</th> </tr> </thead> <tbody> <tr> <td>VE1644A0</td> <td>DADO PRESSACAVO PG 29</td> <td>1.000</td> <td>PZ</td> </tr> <tr> <td>VE1645A1</td> <td>PRESSACAVO PG 29 RIDOTT</td> <td>1.000</td> <td>PZ</td> </tr> </tbody> </table>	Code	Description	Qty	UOM	VE1644A0	DADO PRESSACAVO PG 29	1.000	PZ	VE1645A1	PRESSACAVO PG 29 RIDOTT	1.000	PZ								
Code	Description	Qty	UOM																						
VE1644A0	DADO PRESSACAVO PG 29	1.000	PZ																						
VE1645A1	PRESSACAVO PG 29 RIDOTT	1.000	PZ																						
PE2038A	SCHEDA POTENZA MM PLUS		KPE2038A	MND.MAPS PLUS POWER BOARD KIT	<table border="1"> <thead> <tr> <th>Code</th> <th>Description</th> <th>Qty</th> <th>UOM</th> </tr> </thead> <tbody> <tr> <td>PE2038A0</td> <td>SCHEDA POTENZA MM PLUS</td> <td>1.000</td> <td>PZ</td> </tr> <tr> <td>VI1850A0</td> <td>VITE M4X6 TCB+ NICHELATA</td> <td>12.000</td> <td>PZ</td> </tr> <tr> <td>VM1447A0</td> <td>BUSTA AIRBALL ESD ROSA 230X450 MM</td> <td>1.000</td> <td>PZ</td> </tr> <tr> <td>VM1745A0</td> <td>SUPPORTO PER SCHEDA</td> <td>12.000</td> <td>PZ</td> </tr> </tbody> </table>	Code	Description	Qty	UOM	PE2038A0	SCHEDA POTENZA MM PLUS	1.000	PZ	VI1850A0	VITE M4X6 TCB+ NICHELATA	12.000	PZ	VM1447A0	BUSTA AIRBALL ESD ROSA 230X450 MM	1.000	PZ	VM1745A0	SUPPORTO PER SCHEDA	12.000	PZ
Code	Description	Qty	UOM																						
PE2038A0	SCHEDA POTENZA MM PLUS	1.000	PZ																						
VI1850A0	VITE M4X6 TCB+ NICHELATA	12.000	PZ																						
VM1447A0	BUSTA AIRBALL ESD ROSA 230X450 MM	1.000	PZ																						
VM1745A0	SUPPORTO PER SCHEDA	12.000	PZ																						
VM1745A	SUPPORTO PER SCHEDA		KVM1745A	BOARD SUPPORT 10 PCS KIT	<table border="1"> <thead> <tr> <th>Code</th> <th>Description</th> <th>Qty</th> <th>UOM</th> </tr> </thead> <tbody> <tr> <td>VM1745A0</td> <td>SUPPORTO PER SCHEDA</td> <td>10.000</td> <td>PZ</td> </tr> </tbody> </table>	Code	Description	Qty	UOM	VM1745A0	SUPPORTO PER SCHEDA	10.000	PZ												
Code	Description	Qty	UOM																						
VM1745A0	SUPPORTO PER SCHEDA	10.000	PZ																						

COMPONENT			SPARE PART																														
Code	Description	Image	Code	Description	Kit components																												
VE2000A	TELERUTTORE 4P 30A 230V 50/60HZ		KVE2000A	50/60HZ 230V 30A 4P CONTACTOR KIT	<table border="1"> <thead> <tr> <th>Code</th> <th>Description</th> <th>Qty</th> <th>UOM</th> </tr> </thead> <tbody> <tr> <td>CE1455A0</td> <td>TERMINALE A PUNTALE</td> <td>2.000</td> <td>PZ</td> </tr> <tr> <td>CE1560A0</td> <td>CAVO UNIP AWG18 ST.3135 NERO</td> <td>0.250</td> <td>M</td> </tr> <tr> <td>VE2000A0</td> <td>TELERUTTOR E 4P 30A 230V 50/60HZ</td> <td>1.000</td> <td>PZ</td> </tr> <tr> <td>VI1220A1</td> <td>VITE AUTOFIL. 4.2X11 TCS+ MARUTEX</td> <td>2.000</td> <td>PZ</td> </tr> <tr> <td>VM1075A1</td> <td>CLIP DI FISSAGGIO PER TELERUTTORI</td> <td>4.000</td> <td>PZ</td> </tr> <tr> <td>VM2191A1</td> <td>STAFFA TELERUTTOR E GRANDE VE2000</td> <td>1.000</td> <td>PZ</td> </tr> </tbody> </table>	Code	Description	Qty	UOM	CE1455A0	TERMINALE A PUNTALE	2.000	PZ	CE1560A0	CAVO UNIP AWG18 ST.3135 NERO	0.250	M	VE2000A0	TELERUTTOR E 4P 30A 230V 50/60HZ	1.000	PZ	VI1220A1	VITE AUTOFIL. 4.2X11 TCS+ MARUTEX	2.000	PZ	VM1075A1	CLIP DI FISSAGGIO PER TELERUTTORI	4.000	PZ	VM2191A1	STAFFA TELERUTTOR E GRANDE VE2000	1.000	PZ
					Code	Description	Qty	UOM																									
					CE1455A0	TERMINALE A PUNTALE	2.000	PZ																									
					CE1560A0	CAVO UNIP AWG18 ST.3135 NERO	0.250	M																									
					VE2000A0	TELERUTTOR E 4P 30A 230V 50/60HZ	1.000	PZ																									
					VI1220A1	VITE AUTOFIL. 4.2X11 TCS+ MARUTEX	2.000	PZ																									
					VM1075A1	CLIP DI FISSAGGIO PER TELERUTTORI	4.000	PZ																									
VM2191A1	STAFFA TELERUTTOR E GRANDE VE2000	1.000	PZ																														
VM2191A	STAFFA TELERUTTORE GRANDE VE2000		VM2191A1	STAFFA TELERUTTORE GRANDE VE2000																													
CE1355A	CABLE 5 X 2,5 MMQ H07RNF L = 1,5 MT		KCE1355A	L=1.5M 5x2.5mmq POWER CABLE KIT	<table border="1"> <thead> <tr> <th>Code</th> <th>Description</th> <th>Qty</th> <th>UOM</th> </tr> </thead> <tbody> <tr> <td>CE1355A2</td> <td>CAVO H07RNF 5G2.5 L2.1MT</td> <td>1.000</td> <td>PZ</td> </tr> </tbody> </table>	Code	Description	Qty	UOM	CE1355A2	CAVO H07RNF 5G2.5 L2.1MT	1.000	PZ																				
					Code	Description	Qty	UOM																									
CE1355A2	CAVO H07RNF 5G2.5 L2.1MT	1.000	PZ																														
CN1003A	CONDENSATORE CORAZZATO 6,3 uF		KCN1003A	6,3 uF MOTOR CAPACITOR KIT	<table border="1"> <thead> <tr> <th>Code</th> <th>Description</th> <th>Qty</th> <th>UOM</th> </tr> </thead> <tbody> <tr> <td>CN1003A0</td> <td>CONDENSATO RE CORAZZATO 6,3 uF</td> <td>1.000</td> <td>PZ</td> </tr> <tr> <td>VI1931A0</td> <td>DADO CONDENSATO RE M6x1.65 H4 CH13 ZINC</td> <td>1.000</td> <td>PZ</td> </tr> <tr> <td>VI1932A0</td> <td>RONDELLA DENTELLATA CONDENSATO RE D8 ZINC</td> <td>1.000</td> <td>PZ</td> </tr> </tbody> </table>	Code	Description	Qty	UOM	CN1003A0	CONDENSATO RE CORAZZATO 6,3 uF	1.000	PZ	VI1931A0	DADO CONDENSATO RE M6x1.65 H4 CH13 ZINC	1.000	PZ	VI1932A0	RONDELLA DENTELLATA CONDENSATO RE D8 ZINC	1.000	PZ												
Code	Description	Qty	UOM																														
CN1003A0	CONDENSATO RE CORAZZATO 6,3 uF	1.000	PZ																														
VI1931A0	DADO CONDENSATO RE M6x1.65 H4 CH13 ZINC	1.000	PZ																														
VI1932A0	RONDELLA DENTELLATA CONDENSATO RE D8 ZINC	1.000	PZ																														



COMPONENT			SPARE PART														
Code	Description	Image	Code	Description	Kit components												
MR1004A	MORSETTIERA 7POLI 41A 450V		KMR1004A	FTW 1+2+3/4+5+6 TERMINAL BLOCK KIT	<table border="1"> <thead> <tr> <th>Code</th> <th>Description</th> <th>Qty</th> <th>UOM</th> </tr> </thead> <tbody> <tr> <td>MR1004A1</td> <td>MORSETTIER A 7POLI 41A 450V</td> <td>1.000</td> <td>PZ</td> </tr> </tbody> </table>	Code	Description	Qty	UOM	MR1004A1	MORSETTIER A 7POLI 41A 450V	1.000	PZ				
Code	Description	Qty	UOM														
MR1004A1	MORSETTIER A 7POLI 41A 450V	1.000	PZ														
VE1026A	TRASFORMATORE 230-21-12Vac 90VA		KVE1026A	230-21-12vac 90VA TRANSFORMER KIT	<table border="1"> <thead> <tr> <th>Code</th> <th>Description</th> <th>Qty</th> <th>UOM</th> </tr> </thead> <tbody> <tr> <td>VE1026A0</td> <td>TRASFORMAT ORE 230-21-12Vac 90VA</td> <td>1.000</td> <td>PZ</td> </tr> <tr> <td>VI1950A0</td> <td>VITE AUTOFORANT E 4,2X13 TCB INOX</td> <td>4.000</td> <td>PZ</td> </tr> </tbody> </table>	Code	Description	Qty	UOM	VE1026A0	TRASFORMAT ORE 230-21-12Vac 90VA	1.000	PZ	VI1950A0	VITE AUTOFORANT E 4,2X13 TCB INOX	4.000	PZ
Code	Description	Qty	UOM														
VE1026A0	TRASFORMAT ORE 230-21-12Vac 90VA	1.000	PZ														
VI1950A0	VITE AUTOFORANT E 4,2X13 TCB INOX	4.000	PZ														
VM2387A	MM REMOTE CONTROL SWITCH PROTECTION		VM2387A0	MM REMOTE CONTROL SWITCH PROTECTION													